

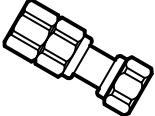

THREADED SWIVEL CONNECTIONS	SWIVEL No.	CONNECTION THREAD SIZES*		APPROX. OVERALL LENGTH "L"	PRESSURE RANGES		
					UP TO 800 PSI	UP TO 1000 PSI	
 FEMALE x FEMALE	11990-7	1/4" (F) N.P.T.	1/4" (F) N.P.T.	2 1/16	✓		
	11990-10	1/4" (F) N.P.T.	1/4" (F) N.P.S.	2		✓	
	11990-14	3/8" (F) N.P.T.	3/8" (F) N.P.T.	2	✓		
	11990-17	1/2" (F) N.P.T.	1/2" (F) N.P.T.	2 5/16	✓		
	11990-20	3/8" (F) N.P.T.	1/4" (F) N.P.S.	1 3/4		✓	
 MALE x MALE	11990-8	1/4" (M) N.P.T.	1/4" (M) N.P.T.	2 1/4	✓		
	11990-13	1/4" (M) N.P.T.	1/4" (M) N.P.S.	2 1/4	✓		
	11990-15	3/8" (M) N.P.T.	3/8" (M) N.P.T.	2 5/16	✓		
	11990-18	1/2" (M) N.P.T.	1/2" (M) N.P.T.	2 3/4	✓		
 MALE x FEMALE	11990-6	1/4" (M) N.P.S.	1/4" (F) N.P.S.	2 1/16		✓	
	11990-9	1/4" (M) N.P.T.	1/4" (F) N.P.T.	2 3/16	✓		
	11990-12	1/4" (M) N.P.T.	1/4" (F) N.P.S.	2 1/8		✓	
	11990-16	3/8" (M) N.P.T.	3/8" (F) N.P.T.	2 1/4	✓		
	11990-19	1/2" (M) N.P.T.	1/2" (F) N.P.T.	2 5/8	✓		
	11990-21	3/8" (M) N.P.T.	1/4" (F) N.P.S.	2		✓	
HOSE SHANK SWIVEL CONNECTIONS	SWIVEL No.	CONNECTION		APPROX. OVERALL LENGTH "L"	FOR HOSE I.D.	PRESSURE RANGES UP TO 800 PSI	
		THREAD SIZE*	"A" DIA.				
 FEMALE x HOSE SHANK	**	11990-60	1/4" (F) N.P.S.	.281"	2 5/8"	1/4"	✓
	**	11990-61	1/4" (F) N.P.S.	.406"	2 3/4"	3/8"	✓
 MALE x HOSE SHANK		11990-62	1/4" (M) N.P.T.	.281"	2 5/16"	1/4"	✓
		11990-63	1/4" (M) N.P.S.		2 3/8"		
		11990-64	1/4" (M) N.P.T.	.406"	2 15/32"	3/8"	✓
		11990-65	1/4" (M) N.P.S.		2 17/32"		

PROVIDE FREE SWIVELING LEAKPROOF CONNECTIONS FOR LIQUID PRESSURES TO 800 PSI AND 1000 PSI HOWEVER, THE HOSE SHANK SWIVELS ARE LIMITED IN ALLOWABLE PRESSURES DEPENDING ON THE TYPE, GRADE, AND CONDITION OF THE HOSE AND HOSE CLAMP BEING USED. THE 11990- SWIVELS PROLONG HOSE LIFE BY PREVENTING KINKING OF THE HOSE...REDUCE SPRAY GUN OPERATOR FATIGUE. RECOMMENDED FOR INTERMITTENT NON-CONTINUOUS SWIVEL REQUIREMENTS. FOR TEMPERATURES UP TO 180°F.

**BRASS CONSTRUCTION**

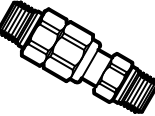
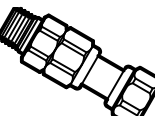
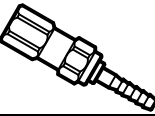

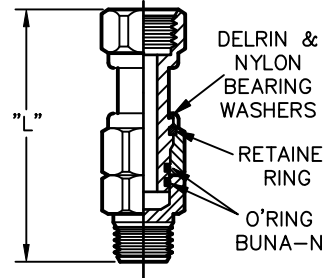
CROSS - SECTION VIEW (TYPICAL)

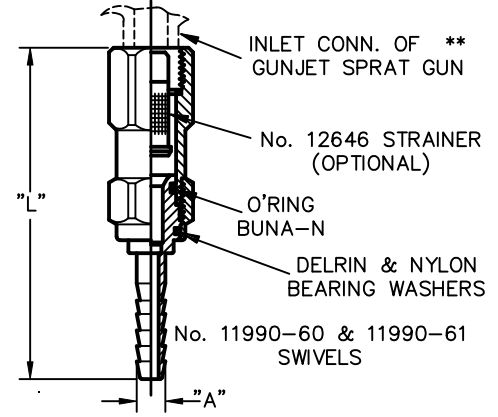

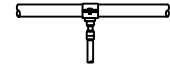
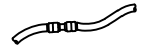
TYPICAL USES		
		
INLET CONN. TO SPRAY GUNS	HOSE TO PIPE FITTING CONN.	HOSE EXTENSION CONNECTIONS

SWIVEL CONNECTION (OR SIZE)	PRESSURE DROP IN P.S.I.									
	2 G.P.M.	3 G.P.M.	4 G.P.M.	5 G.P.M.	6 G.P.M.	10 G.P.M.	15 G.P.M.	20 G.P.M.	30 G.P.M.	40 G.P.M.
1/4" HOSE SHANK	1.1	2.5	4.6	7.2	10	29				
281 TD HOSE SHANK	4.4	10	17	29						
3/8"			1.1	1.7	2.5	7	16	29		
1/2"					.6	1.8	4	7.1	16	29

\*(F)=FEMALE THD, CONN. \*NPT=TAPERED PIPE THD. (M)=MALE THD. CONN. NPS=STRAIGHT PIPE THD. \*\*MAY BE USED WITH THE #12646 STRAINER INSERTED INTO THE INLET OF #22-, #23H- (TO 800 PSI), OR #31-(TO 500 PSI) GUNJETS. SEE SKETCH.

**DESCRIPTION:**  
**NO. 11990 - SWIVELS**



# Spraying Systems Co.®

Spray Nozzles and Accessories  
P.O. Box 7900 - Wheaton, Il. 60189-7900

<b>Rev. No. 1</b>	<b>Data Sheet No.</b>
<b>Ref.</b>	<b>11991</b>
	<b>SHEET OF</b>