

MATRIX® PRO GS

USER MANUAL

Software version 4.32

MATRIX® PRO 840GS



MATRIX® PRO 570GS



TeeJet®
TECHNOLOGIES

A Subsidiary of  Spraying Systems Co.®

GETTING STARTED

#1 Turn Power On





Press the POWER button  to power on the console.

#2 Home Screen

Once the power up sequence has completed, the Home screen will appear with the option to start a new job or continue an existing job.

#3 Go to Unit Setup

1. Press UNIT SETUP bottom tab .

The Configuration  options will be displayed first. Data management , Console settings  and Tools  can be accessed through the side tab keys.

Cultural Setup

1. Press CONSOLE side tab .
2. Press **Cultural**.

Culture is used to configure units, language and time zone settings.

GNSS Setup

1. Press CONFIGURATION side tab .
2. Press **GNSS Receiver Configuration**.

GNSS is used to configure GNSS type, GNSS port and PRN as well as to view GNSS status information.

Implement Setup

1. Press CONFIGURATION side tab .
2. Press **Implement**.





Implement setup is used to establish the various settings associated with straight mode, spreader mode or staggered mode. Settings will vary depending on if an AutoSteer or BoomPilot system is present.

AutoSteer Setup

1. Press CONFIGURATION side tab .
2. Press **AutoSteer**.

When a Steering Control Module (SCM or SCM Pro) is present, assisted/auto steering options will be available. For detailed setup instructions, refer to your specific AutoSteer installation manual.

#4 Go to Guidance Screen

1. Press VEHICLE VIEW GUIDANCE tab , FIELD VIEW GUIDANCE tab  or REALVIEW GUIDANCE tab .
2. Press NAVIGATION AND GUIDANCE OPTIONS tab  to display navigation options.

Choose a guidance mode

- ▶ Straight AB 
- ▶ Curved AB 
- ▶ Circle Pivot 
- ▶ Last Pass 
- ▶ NextRow 
- ▶ Adaptive Curve 

Mark A and B Points

To establish a AB guideline.

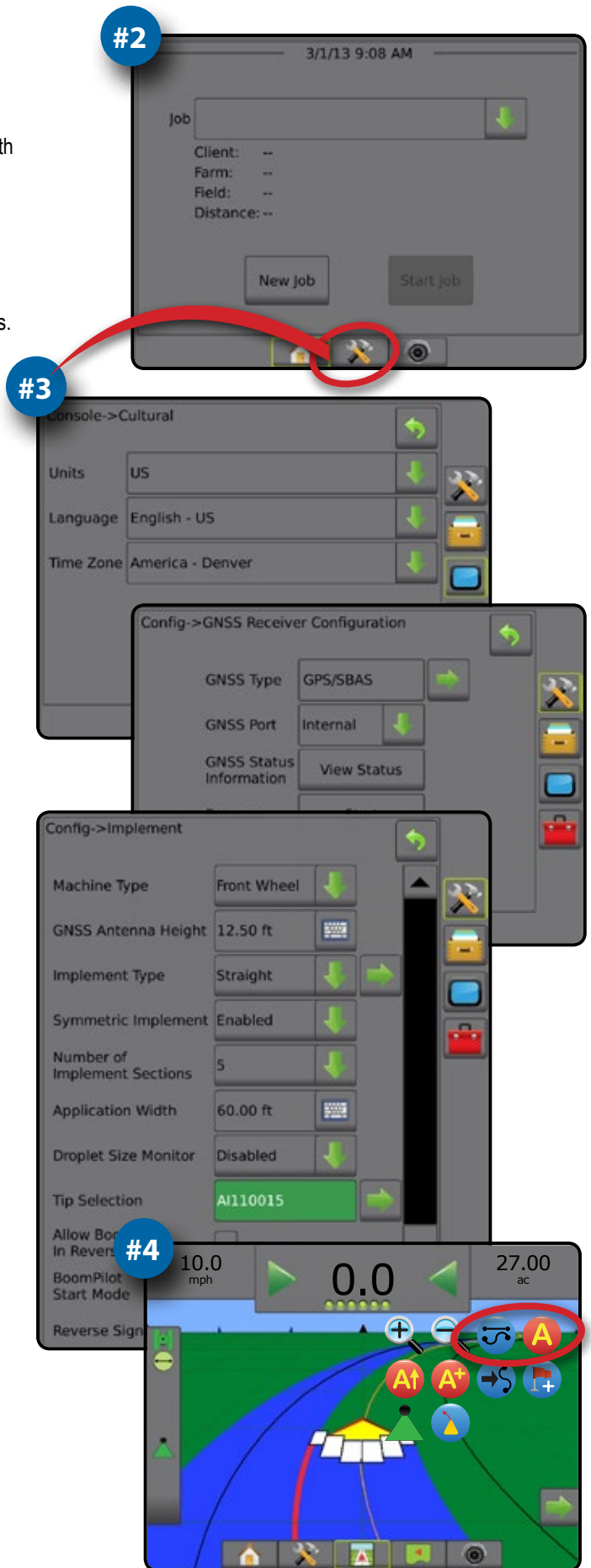

Table of Contents

CHAPTER 1 – INTRODUCTION	1
Product Upgrades Available	1
SYSTEM COMPONENTS	1
Matrix Pro 570GS Console	1
Matrix Pro 840GS Console	2
Buttons	2
Additional Information	2
RealView® Camera	3
CONFIGURATIONS	3
BASIC SCREEN USE	3
Bottom Tab Keys	3
Unavailable Options When Job is Active	3
Console Screen Colors	4
Simple or Advanced Mode	4
Warnings and Information Pop-ups	5
Setup Option Information	5
Drop Down Menu Selections	5
Scrolling Screens	5
Keyboard Entry Screen	6
Next Page	6
Checkboxes	6
CHAPTER 2 – JOBS / HOME SCREEN	7
Simple Mode	7
Advanced Mode	7
SIMPLE MODE	8
New Job	8
Continue Job	8
Close Job	8
ADVANCED MODE	8
New Job	8
Start Job	8
<i>Distance</i>	8
Close Job	8
CHAPTER 3 – FULL SCREEN VIDEO VIEW	9
Camera Snapshot	10
VSM Camera Options	10

INTRODUCTION
 HOME
 FULL SCREEN
 SETUP
 GNSS
 IMPLEMENT
 GUIDANCE
 RATE CONTROL
 APPENDIX



OVERVIEW 11

 **CONFIGURATION** 12

- Implement..... 13
 - Implement Type* 13
 - Single Section Setup 13
 - Multiple Sections with SDM/SFM Setup 14
 - Droplet Size Monitor 15
 - Tip Selection 15
 - Reverse Sense Options 16
- Mapping and Guidance [Lightbar]..... 16
 - Mapping and Guidance [Console Only] 16
 - Mapping and Guidance Using an External Lightbar 17
 - User Entered Mapping Location 18
- GNSS Receiver Configuration 19
 - PRN Not Shown* 19
- Video 19
 - Video Setup Unavailable* 19
- Sensors 20
 - Sensors Unavailable* 20
 - Input/Output Module Pressure Sensor 20
 - Droplet Size Monitor* 20
- Product 21
- Third-Party Rate Control 21
- AutoSteer 22
 - Assisted/Auto Steering Unavailable* 22
 - FieldPilot [using a SCM] 22
 - FieldPilot Pro / UniPilot Pro [using a SCM Pro] 22
 - Active Vehicle* 23
- Tilt Correction 24
 - Field Level Unavailable* 24
 - Tilt Correction Unavailable* 24

 **DATA MANAGEMENT** 24









- Job Data 24
 - Job Data Unavailable* 25
 - Transfer 25
 - Manage 26
- Reports 27
- Options (Job Mode) 27
- Machine Settings 28
 - Transfer 29
 - Manage 29
 - Copy Machine Profile* 30

 CONSOLE	30
About	31
Display	31
Cultural	32
Audio Volume	32
Demo GNSS	33
Restart Demo GNSS	33
Feature Unlock.....	33
 TOOLS	34
Upload Software	34
Extras.....	35
CHAPTER 5 – GNSS RECEIVER CONFIGURATION	36
GNSS Receiver Configuration.....	36
GNSS Type	36
GNSS Port	37
<i>External Receiver Minimum Configuration Requirements</i>	37
GNSS Status Information	38
<i>GNSS Status Information on Guidance Screens</i>	38
<i>GGA Requirements</i>	38
Program	39
PRN	39
<i>Alternate PRN</i>	39
<i>PRN Not Shown</i>	39
Show Refresh GNSS Position Button	40
GNSS Glossary.....	40
CHAPTER 6 – IMPLEMENT SETUP	42
IMPLEMENT TYPE	42
Section Numbers.....	42
Straight	43
Single Section	43
Multiple Sections.....	43
Spreader – TeeJet	44
Single Section	44
Multiple Sections.....	45
Spreader – OEM	47
Single Section	47
Multiple Sections.....	47
Staggered	48
Multiple Sections.....	48
APPLICATION OR WORKING WIDTH	50
Single Section	50
Multiple Sections.....	50

MATRIX® Pro 570GS • MATRIX® Pro 840GS

INTRODUCTION
 HOME
 FULL SCREEN
 SETUP
 GNSS
 IMPLEMENT
 GUIDANCE
 RATE CONTROL
 APPENDIX

IMPLEMENT LATERAL OFFSET DISTANCE ADJUSTMENT		51
GNSS Offset Adjustment Calculation		51
Implement Lateral Offset Adjustment		52
REVERSE SENSE		53
Reverse on Guidance Screens		53
TIP SELECTION		54
Preset		54
Current Tip		55
DROPLET SIZE MONITOR		55
Setup		55
Enable/Disable DSM		55
Tip Selection / Current Tip		56
Input/Output Module Pressure Sensor		56
Operation		56
Status Bar		56
<i>Droplet Size Chart</i>		56
Guidance Bar		56
BOOMPILOT SECTION CONTROL		57
CHAPTER 7 – GUIDANCE AND MAPPING		58
Overview		58
Screens Options		59
GUIDANCE BAR		63
Navigation Activity & Boom Status		63
<i>Cross Track Error</i>		63
Selectable Information		63
STATUS BAR		64
Status/Information Screens		64
NAVIGATION SCREENS		66
Vehicle View		66
Field View		67
RealView Guidance		68
GUIDANCE MODES		69
Straight AB Guidance		69
Curved AB Guidance		69
Adaptive Curve AB Guidance		69
Circle Pivot Guidance		69
Last Pass Guidance		69
NextRow Guidance		70
No Guidance		70

GUIDELINES		70
Marking A and B Points		70
A+ Nudge Feature		71
Next Guideline Feature		72
Last Pass Guidelines		72
NextRow Guidelines		73
Azimuth Degree		73
 RETURN TO POINT		74
Marking a Return Point		74
Delete the Return Point		74
Guidance to a Return Point		74
 BOOMPILOT		75
No Section Control Module		75
Console Only		75
With Optional Work On/Off Switch		75
<i>Using the Console</i>		75
With TeeJet Section Control Module and Switchbox or ISM		75
With TeeJet Section Control Module		76
 CURVED LOOKAHEAD		76
 REFRESH GNSS POSITION		76
 BOUNDARIES AND POLYGONS		77
<i>Mapping Location</i>		77
Boundaries		77
Delete Last Marked Boundary		79
Boundary on Status Bar		79
Polygons		79
Delete Last Marked Polygon		80
 MAPPING OPTIONS		81
Polygon Mapping		81
Rate Control Mapping		81
 ZOOM IN/OUT		82
Vehicle View		82
Field View		82
 PAN MODE		82
 REALVIEW SPECIFIC OPTIONS		83
RealView Guidance Options		83
Camera Snapshot		84
VSM Camera Options		84

INTRODUCTION
 HOME
 FULL SCREEN
 SETUP
 GNSS
 IMPLEMENT
 GUIDANCE
 RATE CONTROL
 APPENDIX

CHAPTER 8 – THIRD-PARTY RATE CONTROL 85

THIRD-PARTY RATE CONTROL UNLOCK 85

SETUP OPTIONS 86

Third-Party Rate Control	86
Product	86

GUIDANCE SCREEN OPTIONS 87

Guidance Bar	87
Status Bar	87

MAPPING OPTIONS 88

<i>Duplicating and Transferring Maps</i>	88
Coverage Map	88
<i>On Screen Mapping</i>	88
Polygons Map	89
<i>On Screen Mapping</i>	89
Prescription Map	89
<i>On Screen Mapping</i>	89
Application and Target Rate Maps	89
Application Map	89
<i>On Screen Mapping</i>	89
Target Rate Map	90
<i>On Screen Mapping</i>	90
<i>Target Rates</i>	90

APPENDIX A – SYSTEM CONFIGURATIONS 91

APPENDIX B – MATRIX PRO GS CONSOLE MENU SETTINGS 93

APPENDIX C – UNIT SPECIFICATIONS 97

APPENDIX D – SETTING RANGES 97

APPENDIX E – UTM COORDINATES AND ZONES 98

CHAPTER 1 – INTRODUCTION

The Matrix Pro GS allows the management of multiple connected modules plus GNSS mapping, Guidance, FieldPilot®, BoomPilot®, Rate Control, and data collection in a single console using CAN bus technology. This replaces multiple consoles in the cab with one robust system.

Product Upgrades Available

- FieldPilot® or FieldPilot® Pro auto steering
- UniPilot® or UniPilot® Pro assisted steering
- BoomPilot® automated boom section control
- Tilt Gyro Module
- Video Selection Modules for up to 8 cameras
- External GNSS receiver or antenna upgrades
- Fieldware® Link enhanced data organization application
- Pressure Sensor Interface Kit for Droplet Size Monitor
- Third-Party Rate Control

SYSTEM COMPONENTS

Matrix Pro 570GS Console

The Matrix Pro 570GS is designed to provide years of service under typical agricultural operating conditions. A tight fitting enclosure, combined with rubber covers for all connectors mean that typical dusty environments will not cause operational problems. While occasional splashing of water will not damage the unit, the Matrix Pro 570GS is not designed for direct exposure to rain. Take care not to operate the Matrix Pro GS in wet conditions.

Figure 1-1: Matrix Pro 570GS Console Front and Back



MATRIX® Pro 570GS • MATRIX® Pro 840GS

INTRODUCTION

HOME

FULL SCREEN

SETUP

GNSS

IMPLEMENT

GUIDANCE

RATE CONTROL

APPENDIX

Matrix Pro 840GS Console

The Matrix Pro 840GS is designed to provide years of service under typical agricultural operating conditions. A tight fitting enclosure, combined with rubber covers for all connectors mean that typical dusty environments will not cause operational problems. While occasional splashing of water will not damage the unit, the Matrix Pro 840GS is not designed for direct exposure to rain. Take care not to operate the Matrix Pro GS in wet conditions.

Figure 1-2: Matrix Pro 840GS Console Front and Back



Buttons

Power On/Off

On – Press the POWER button  to power on the console. Upon power up, the Matrix Pro GS will begin its start up sequence.

Off – Press and briefly hold the POWER button  until a confirmation screen acknowledges shut down mode.

WARNING! Wait 10 seconds before restarting the console.

Home (Matrix Pro 840GS only)

The Home button  provides a shortcut to the Home screen.

Up/Down (Matrix Pro 840GS only)

The Up/Down buttons  adjust the vehicle's view or perspective to the horizon from vehicle view to bird's eye view in Vehicle View and Field View Guidance.

Additional Information

All changes are saved automatically.

The console needs to be cycled off and back on when changing or attaching equipment to the Matrix Pro GS system.

Start Up Sequence

The console takes approximately two minutes to power up. During this time a series of screens will be displayed, LEDs will power on and off, and brightness levels will fluctuate. Once the power up sequence has completed, the Home screen will appear.

Recommended Antenna Installation

The GNSS antenna should be mounted as far forward as possible on top of the cab on a metal surface of at least 4 in / 10 cm square.

RealView® Camera

The TeeJet Technologies RealView camera allows video images to be displayed on the Matrix Pro GS screen. The camera can be pointed forward to enable RealView guidance over video, or it can be positioned to view other operational aspects of your equipment. The camera is equipped with a flexible RAM mount, integral sun shade and provides infrared illumination, allowing clear video images even in dark conditions.

CONFIGURATIONS

The diagram that was in this location for previous software versions has been moved to the appendix.

BASIC SCREEN USE





The Matrix Pro GS can be used as a simple current job system or advanced multi-job system. Regardless of which mode the console is in, the basic screen functions are the same.

- Bottom Tabs and Side Tabs access the various screens and sub-screens
- Warnings and Information Pop-ups inform user of console activities and details on setup or guidance functions
- Setup options can easily be set using the drop down menus or keyboard entry screens

To quickly find a setup feature, see “Matrix Pro GS Console Menu Settings” in this manual.

Bottom Tab Keys

The bottom tab keys are always available on screen. These keys give access to jobs, setup options, and navigation.

-  Home/Job Screen
-  System Setup
-  Vehicle View Guidance
-  Field View Guidance
-  RealView guidance or RealView camera full screen video view

NOTE: RealView Guidance options are only available with a camera installed on the system.

Figure 1-3: Bottom Tab Keys

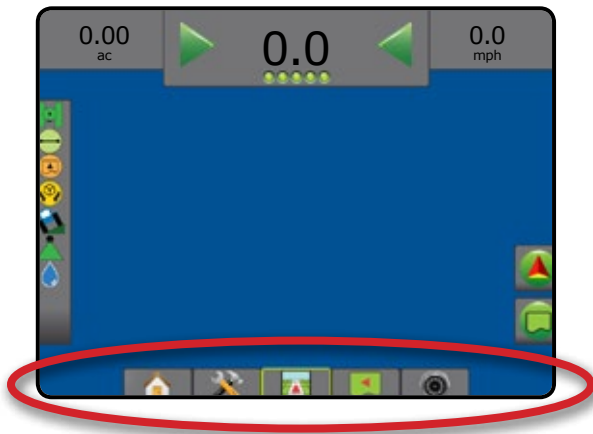

Unavailable Options When Job is Active

When a job is active some setup options are unavailable: see “Matrix Pro GS Console Menu Settings” in this manual.

Figure 1-4: Examples of Unavailable Options

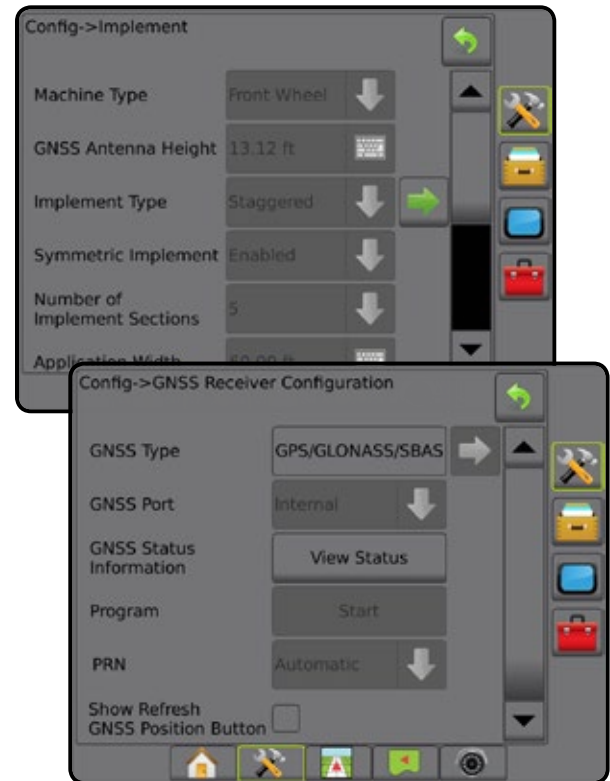

Console Screen Colors



The console is available in six color schemes. From the System Setup Bottom Key, press CONSOLE side tab  and enter the **Display** options. Press DOWN arrow  to access the Color Scheme options to select color mode.

Figure 1-5: Color Schemes



Simple or Advanced Mode

To change between simple mode and advanced mode, see the configuration chapter under Data → Options.

In simple mode, only one job will be available at a time. Only bounded area and coverage areas are displayed on the home screen. Only the current job is available for saving in Reports. Use with Fieldware Link is not available.

Figure 1-6: Simple Mode Home Screen

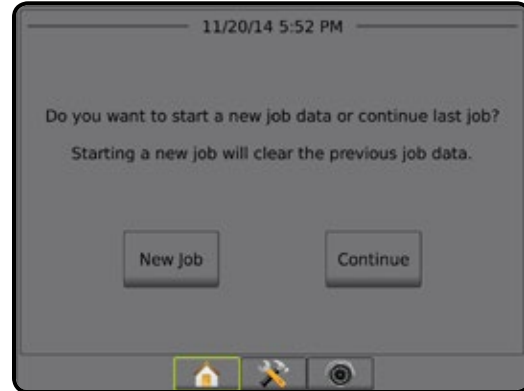

In advanced mode, more than one job will be available at any time. Client, farm, field and job names; bounded and coverage areas; application time; and distance from selected job are displayed on the home screen. All saved job profiles can be exported as a PDF, SHP or KML file to a USB drive using Data-> Reports.

Client information, farm information, field information, and prescription maps can only be inputted using Fieldware Link. A job name can only be edited using Fieldware Link.

A user can duplicate jobs for reuse of guidelines, boundaries, applied data, prescription map and/or polygons using Fieldware Link or Data-> Job Data-> Manage in the console.

Figure 1-7: Advanced Mode Home Screen

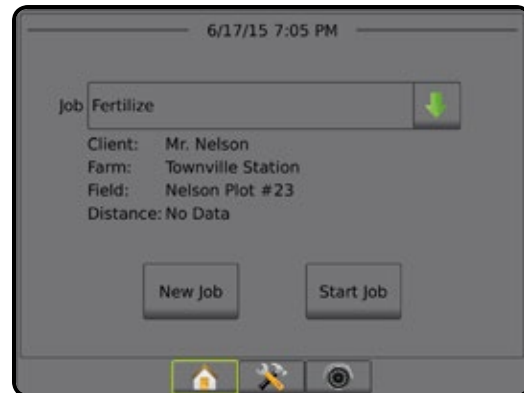

Warnings and Information Pop-ups

A pop-up warning or information box will be displayed for approximately five (5) seconds. To remove the information box, tap anywhere on the screen.

Figure 1-8: Example of Information Text Box

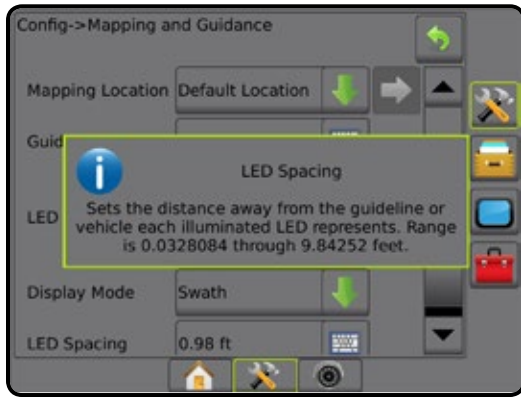

Setup Option Information

Press the option's icon or option's name of any menu item to display a definition and range values of that item. To remove the information box, press anywhere on the screen.

Figure 1-9: Example of Information Text Box

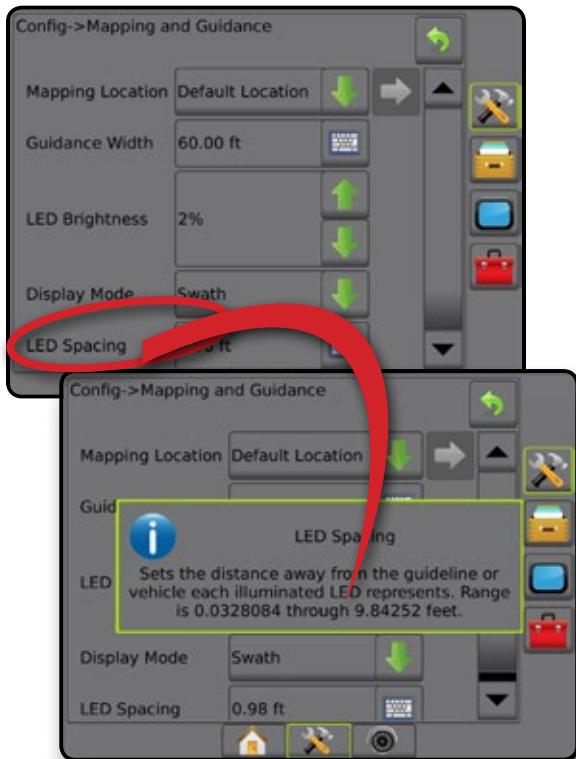

Drop Down Menu Selections

Press DOWN arrow ↓ to access the options. Use the UP/DOWN arrows ▲ ▼ or slide bar if necessary to scroll through the extended list. Select the appropriate option. To close the list without selecting an option, tap anywhere on the screen outside the drop down menu.

Figure 1-10: Example of Drop Down Menu

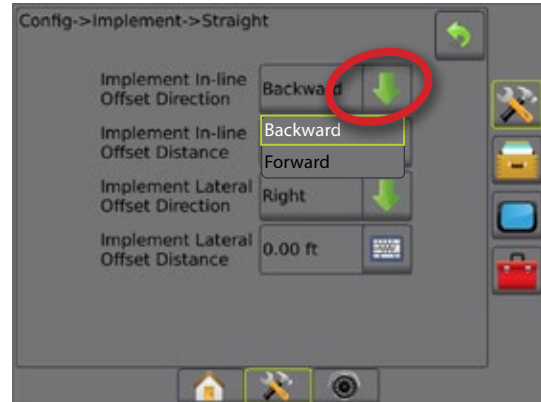

Scrolling Screens

Some screens have more information or options that are visible beyond the current screen. Use the UP/DOWN arrows ▲ ▼ or slide bar to access additional options or information not currently visible on the screen.

Figure 1-11: Example of Scrolling Screen

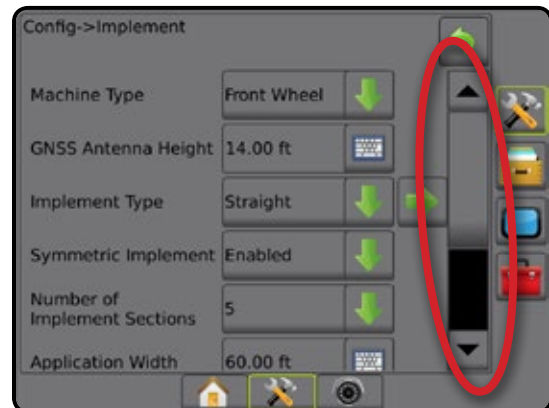

Keyboard Entry Screen

Press the KEYPAD icon . Use the numeric keypad to enter a value.

Press the ACCEPT icon  to save the settings or the CANCEL icon  to leave the keypad without saving.

Figure 1-12: Example of Keyboard

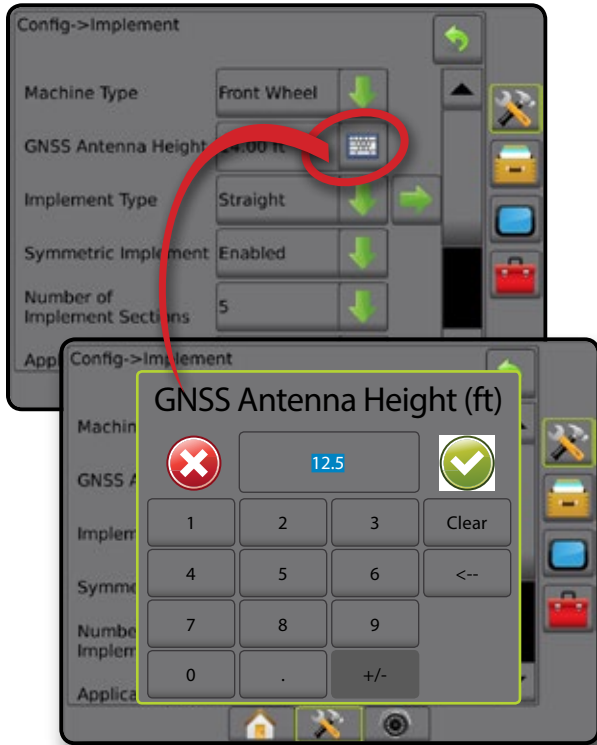

Next Page

Press the NEXT PAGE arrow  to set up additional options for the selected item.

Figure 1-13: Example of Next Page



Checkboxes

Press the CHECKBOX / to select or deselect.

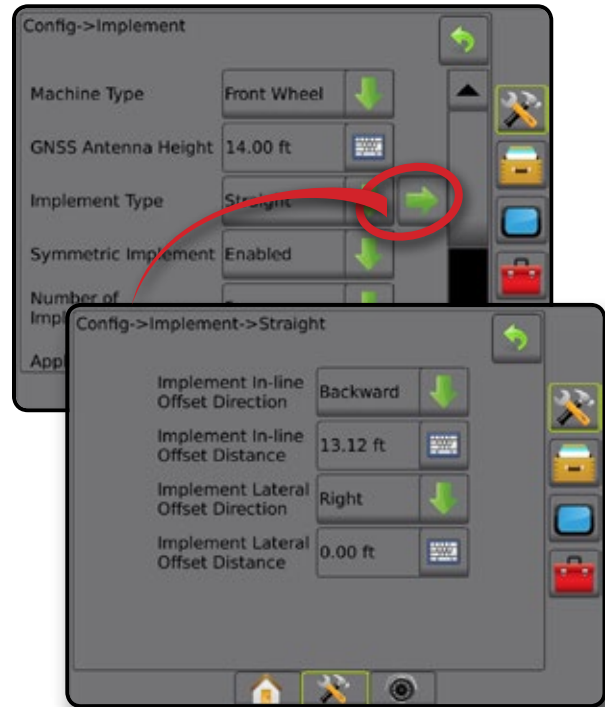
Figure 1-14: Examples of Checkboxes

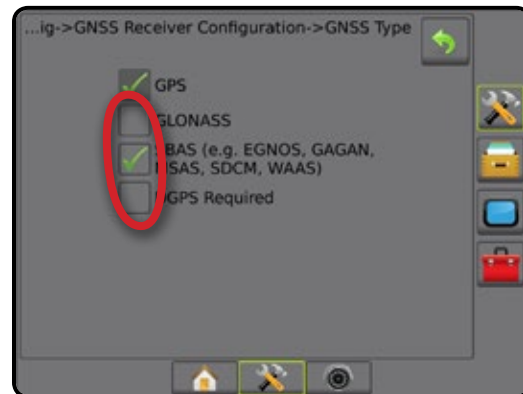

CHAPTER 1 – JOBS / HOME SCREEN

Once the power up sequence has completed and the console is receiving GNSS, the Home screen will appear with the option to start a new job or continue an existing job.

Setup for the specific machine and its components must be completed before starting a job. Once a job is active, some setup options can no longer be changed. See “Matrix Pro GS Console Menu Settings” in the appendix of this manual.

To change between simple and advanced mode, go to Data-> Options-> Job Mode in the System Setup.

Simple Mode

In simple mode, only one job will be available at a time. Only bounded area, coverage areas, and application time are displayed on the home screen. Only the current job is available for saving in Reports. Use with Fieldware Link is not available.

Figure 1-1: Simple Mode Home Screen

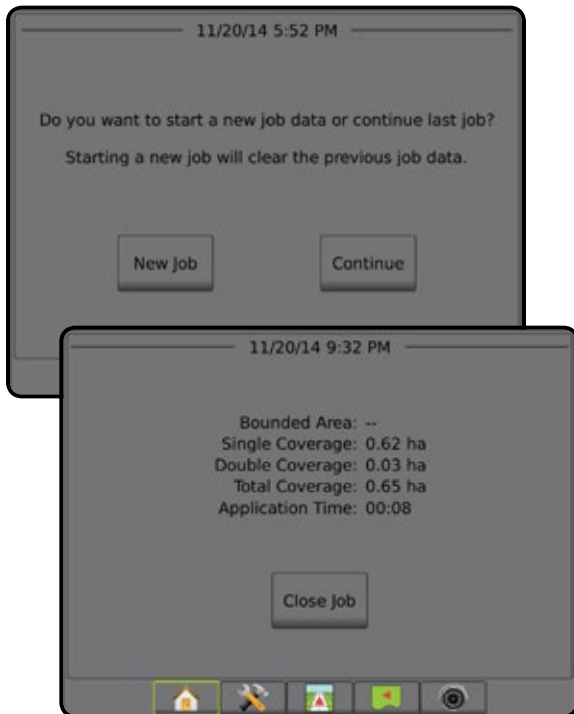

Advanced Mode

In advanced mode, more than one job will be available at any time. Client, farm, field and job names; bounded and coverage areas; application time; and distance from selected job are displayed on the home screen. All saved job profiles can be exported as a PDF, SHP or KML file to a USB drive using Data-> Reports.

Client information, farm information, field information, and prescription maps can only be inputted using Fieldware Link. A job name can only be edited using Fieldware Link.

A user can duplicate jobs for reuse of guidelines, boundaries, applied data, prescription map and/or polygons using Fieldware Link or Data-> Job Data-> Manage in the console.

Figure 1-2: Advanced Mode Home Screen

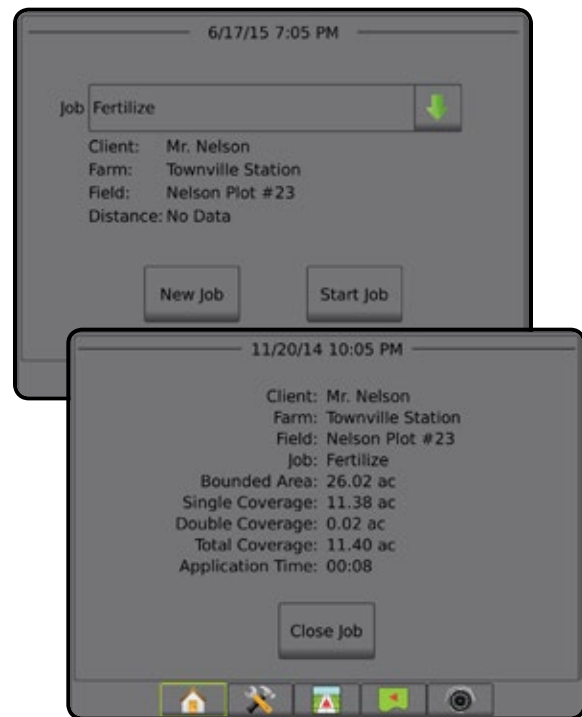

SIMPLE MODE

Once the power up sequence has completed, the Home screen will appear with the option to start a new job or continue an existing job.

The console must have GNSS before starting or continuing a job.

New Job

Starting a new job will clear the previous job data.

To start a New Job:

1. On the Home screen , press **New Job**.

The console will jump to Vehicle View.

Continue Job

To continue the existing job:

1. On the Home screen , press **Continue**.

The console will jump to Vehicle View and begin providing navigation information.

If a selected job is in a UTM zone other than the current or adjacent UTM zone, **Continue** will be disabled.

NOTE: For more information, see the UTM Zone Appendix.

Close Job

To close a job:

1. On the Home screen , press **Close Job**.

To create a report of the job when closing a job:

1. Insert a USB drive into the USB port of the console.
2. On the Home screen , press **Close Job**.
3. Select:
 - ▶ Yes – to create a report of the last job
 - ▶ No – to return to the Home screen without saving

ADVANCED MODE

Once the power up sequence has completed, the Home screen will appear with the option to start a new job or continue an existing job.

The console must have GNSS before starting or continuing a job.

New Job

Starting a new job will clear the previous job data.

To start a New Job:

1. On the Home screen , press **New Job**.

2. Press:

- ▶ Yes – to automatically generate a name
- ▶ No – to enter a name using the on screen keyboard



Client, farm, and field information are inputted using Fieldware Link.

The console will jump to Vehicle View.

Start Job

The Matrix Pro GS is programmed with a field finder tool to assist the user in finding the job closest to the vehicle's location. With GPS acquired, the job pick list will be updated every ten seconds. During this update, the list of jobs is sorted by distance and the closest two jobs are displayed on the top of the list. The remaining jobs are listed beneath these.

To continue the existing job:

1. On the Home screen , press DOWN arrow  to access the list of jobs saved in the console.
2. Select the job name to be started/continued.
3. Press **Start Job**.

The console will jump to Vehicle View and begin providing navigation information.

Distance

If a selected job is in a UTM zone other than the current or adjacent UTM zone, "Out of Range" will be displayed next to Distance, and **Start Job** will be disabled.

NOTE: For more information, see the UTM Zone Appendix.

If a selected job has no recorded information, Distance will show "No Data".

Close Job

To close a job:

1. On the Home screen , press **Close Job**.

To create a report of the job when closing a job:

1. Insert a USB drive into the USB port of the console.
2. On the Home screen , press **Close Job**.
3. Select:
 - ▶ Yes – to create a report of the last job
 - ▶ No – to return to the Home screen without saving

CHAPTER 1 – FULL SCREEN VIDEO VIEW

RealView Full Screen Video View allows live video input to be displayed. View video feed(s) and setup cameras without GNSS available. Options for RealView Guidance are not available on this screen.

- ▶ Single Camera – a single camera is directly attached to the console
- ▶ Video Selection Module – if a Video Selection Module (VSM) is installed on the system, two (2) video options are available:
 - One Camera View – one of up to eight camera inputs can be selected to change the view of the video input.
 - Split Camera View – one of two sets of four camera inputs (A/B/C/D or E/F/G/H) can be selected to divide the screen into four separate video feeds.

To adjust the camera view [reverse, upside down], go to Setup-> Configuration-> Video.

To enter Full Screen Video mode:







1. Press REALVIEW CAMERA FULL SCREEN VIDEO VIEW bottom tab .
2. Press REALVIEW OPTIONS tab  to display RealView options.
3. Select from:
 - ▶ Single Camera View  [VSM only] – one (1) of up to eight (8) camera inputs can be selected to change the view of the video input
 - ▶ Split Camera View  [VSM only] – one (1) of two (2) sets of four (4) camera inputs (A/B/C/D or E/F/G/H) can be selected to divide the screen into four separate video feeds
 - ▶ RealView Camera Image Capture  – saves a still photo of the current view on the screen to a USB drive

Figure 1-1: RealView Full Screen Video View

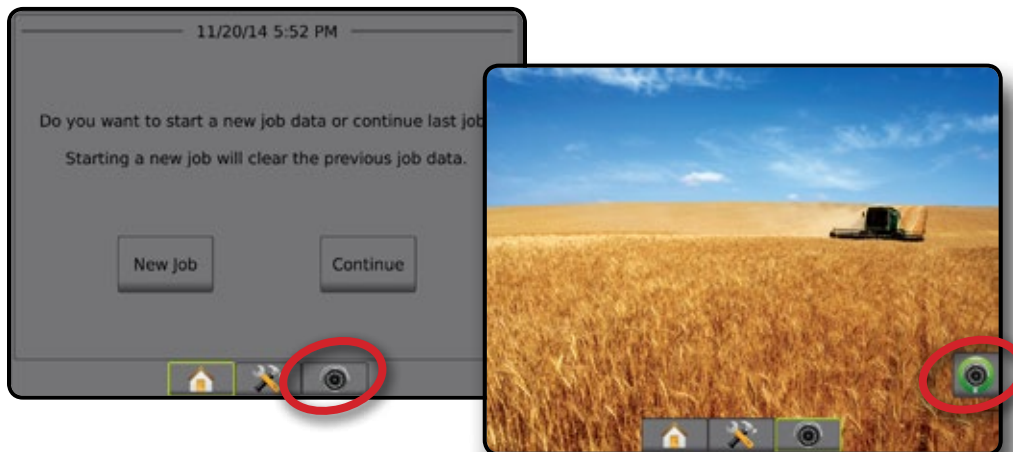

Camera Snapshot

 RealView Camera Snapshot saves a still photo of the current view on the screen to a USB drive.





1. Insert USB drive.
2. Press REALVIEW CAMERA FULL SCREEN VIDEO VIEW bottom tab .
3. Press REALVIEW OPTIONS tab  to display RealView options.
4. Press CAMERA SNAPSHOT icon .

Figure 1-2: RealView Camera Full Screen Video View

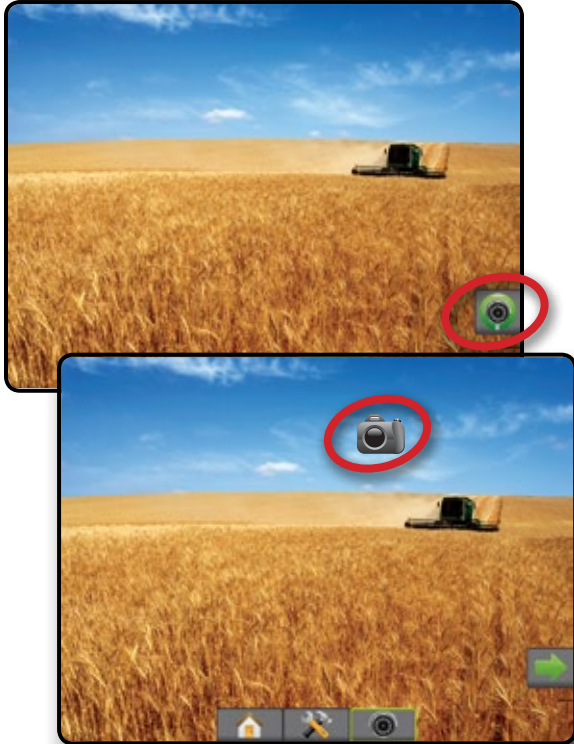

VSM Camera Options

  If a Video Selection Module (VSM) is installed on the system, two (2) video options are available:





1. Press REALVIEW CAMERA FULL SCREEN VIDEO VIEW bottom tab .
2. Press REALVIEW OPTIONS tab  to display RealView options.
3. Select from:
 - ▶ Single Camera View  – one (1) of up to eight (8) camera inputs can be selected to change the view of the video input.
 - ▶ Split Camera View  – one (1) of two (2) sets of four (4) camera inputs (A/B/C/D or E/F/G/H) can be selected to divide the screen into four separate video feeds.

Figure 1-3: Single Camera Selection with VSM



Figure 1-4: Select Split View with VSM



CHAPTER 1 – SYSTEM SETUP

System Setup is used to configure the console, the machine and its implements. Four side tabs access options for Machine/Implement Configuration, Data Management, Console Settings, and Tools.

OVERVIEW

Four side tabs access setup options for:

-  Configuration
 - Implement (Straight, Spreader, or Staggered Implement configurations; Tip Selection information including Droplet Size Monitor, Reverse configuration)
 - Mapping and Guidance (Mapping Location, Lightbar, External Lightbar)
 - GNSS Receiver Configuration
 - Video Configuration
 - Sensors (Input/Output Module (IOM) Pressure Sensor)
 - Product configuration
 - Third-party rate control configuration
 - AutoSteer
 - ◀ FieldPilot (Valve Setup, Steering Settings, Valve Test, Valve Diagnostics, Steering Wheel Sensor, Steering Angle Sensor)
 - ◀ FieldPilot Pro / UniPilot Pro (Manage Vehicle, Calibrations, Adjustments, Select QI Values, Transport Mode, Service Mode)
 - Tilt Correction



-  Data Management
 - Job Data (Transfer, Manage)
 - Reports
 - Options (Job Mode)
 - Machine Settings (Transfer, Manage)
-  Console Settings
 - About (System Information)
 - Display
 - Cultural
 - Audio Volume
 - Demo GNSS
 - Feature Unlock
-  Tools
 - Upload Software
 - Extras (Calculator, Units Converter)

Figure 1-1: Setup Options



CONFIGURATION

Configuration is used to configure the system components including implements, guides, steering, monitors and sensors.

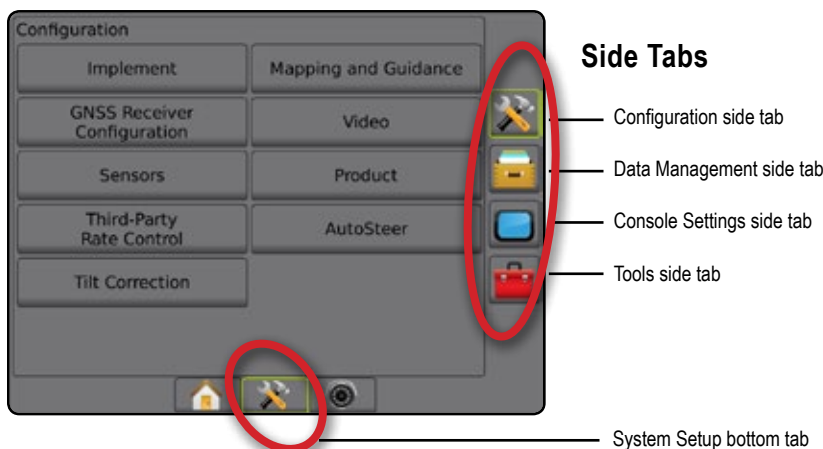
NOTE: Feature availability will vary depending on the devices available and unlocked on the Matrix Pro GS system.



1. Press SYSTEM SETUP bottom tab .
2. Press CONFIGURATION side tab .
3. Select from:
 - ▶ Implement – used to set (as appropriate) machine type, GNSS antenna height, implement type, symmetric implement layout, section output modules, number of implement sections, application/working width, droplet size monitor, tip selection, tip spacing, BoomPilot start mode, Reverse Sense Module
 - In Straight Mode – in-line/lateral implement offset direction/distance, overlap percentage, implement delay on/off time
 - In Spreader Mode:
 - TeeJet – antenna to disks distance, lateral implement offset direction/distance, overlap percentage, delay on/off times, spread offset distance, section offset distances, section lengths
 - OEM – antenna to disks distance, lateral implement offset direction/distance, start/stop distance, section start/stop offset distances
 - In Staggered Mode – in-line/lateral section 1 offset direction/distance, overlap percentage, delay on/off times, section offsets
 - ▶ Mapping and Guidance – used to configure the mapping location, guidance width, cross track error shown on the lightbar
 - ▶ GNSS Receiver Configuration – used to establish GNSS type, port, and PRN, as well as to view GNSS status information
 - ▶ Video – used to set up individual cameras
 - ▶ Sensors – used to establish pressure sensor settings
 - ▶ Product – used to configure product name, color mapping maximum/minimum rate limits and corresponding display colors
 - ▶ Third-Party Rate Control settings – used to configure hardware interface and communication.
 - ▶ AutoSteer – used to enable/disable and calibrate assisted/auto steering
 - FieldPilot – used to establish valve setup settings, steering settings, steering wheel and steering angle sensor settings, and to perform valve tests or valve diagnostics
 - FieldPilot Pro / UniPilot Pro – used to manage vehicle settings, calibrate sensors, select QI values, as well as establish transport mode and service mode
 - ▶ Tilt Correction – used to enable/disable and calibrate the tilt correction function, and improve application on hilly or sloped terrain

Figure 1-2: Configuration Options



Implement

Implement Setup is used to establish the various settings associated with straight mode, spreader mode, or staggered mode. Available settings will vary depending on the specific equipment present in the system.

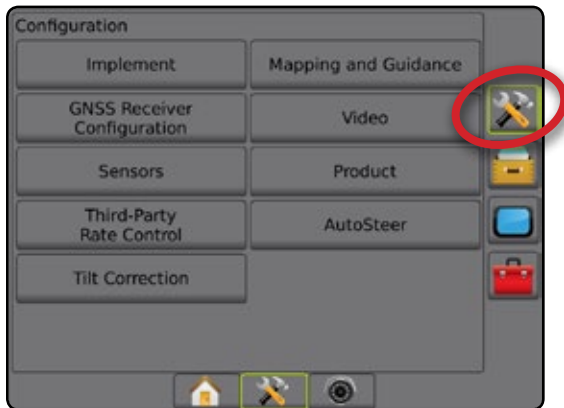
This section includes setup options for these implement configurations:

- ▶ Single Section
- ▶ Multiple Sections with Section Driver Module or Switch Function Module

NOTE: For more information, see the *Implement* chapter of this manual.

Implement Type

Implement type selects the type of application pattern that most closely represents your system.

- In Straight Mode – the boom sections have no length and are on a line a fixed distance from the antenna
- In Spreader Mode – a virtual line is created in line with the delivery disks from which the application section or sections can vary in length and can be at different distances from the line (availability depends on the specific equipment in the system)
- In Staggered Mode – a virtual line is created in line with Section 1 from which the application section or sections have no length and can be at different distances from the line (availability depends on the specific equipment in the system)

NOTE: For more information, see "Implement Type" in the *Implement* chapter of this manual.

Figure 1-3: Implement Type – Straight

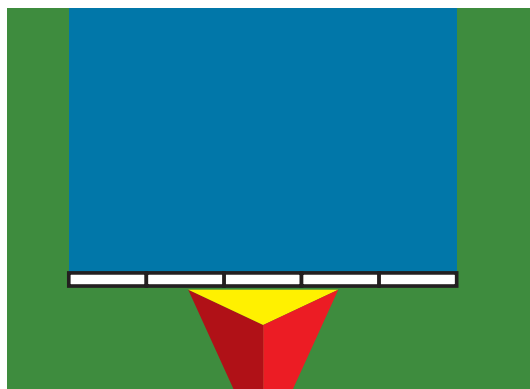

Figure 1-4: Implement Type – Spreader

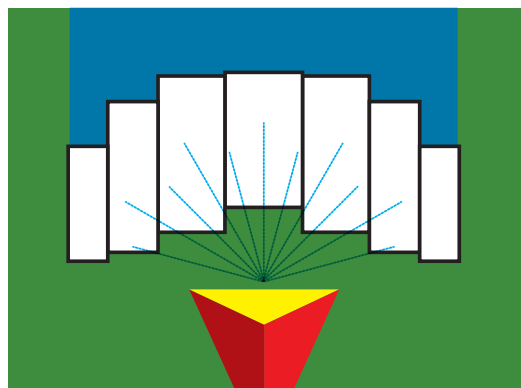



Figure 1-5: Implement Type – Staggered



Single Section Setup

Single Section Setup is used when a SmartCable, Section Driver Module (SDM), or Switch Function Module (SFM) is not on the system (that is, no section control is present). The entire boom or delivery area is considered to be one section.

1. Press CONFIGURATION side tab .
2. Press **Implement**.
3. Select from:
 - ▶ Machine Type [when available] – used to select the type of machine that most closely represents your machine
 - ▶ GNSS Antenna Height [when available] – used to measure the height of the antenna from the ground
 - ▶ Implement Type – used to select the layout of the sections for the applied product location
 - ▶ Working Width [Spreader Implement Type] – used to enter the total width of the implement
 - ▶ Application Width [Straight Implement Type] – used to enter the total width of the implement
 - ▶ Droplet Size Monitor [when available] – used to enable droplet size monitoring for up to five preselected sprayer tips
 - ▶ Tip Selection [when available] – used to select the type of sprayer tip (series and capacity) for determining droplet size information





- ▶ Applied Alert – used to establish an alert to signal when exiting or entering an applied area
 - ▶ BoomPilot Start Mode – used to establish whether BoomPilot will be controlled by speed or by the BoomPilot icon
 - ▶ BoomPilot Icon – used to activate the guidance screen icon for manually controlling on-screen application painting
4. Press NEXT PAGE arrow  to set up specific implement options. See the Implement chapter for details.
 5. Press RETURN arrow  or CONFIGURATION side tab  to return to the main Configuration screen.

Figure 1-6: Implement – Single Section Setup



Multiple Sections with SDM/SFM Setup

Multiple Sections with SDM/SFM Setup is used when a Section Driver Module (SDM) or Switch Function Module (SFM) is on the system. The boom or delivery area can include up to 15 sections of varying width and (in spreader mode) length. Additional options available with an SDM include Application Overlap, Application Delay, and Staggered Mode.

1. Press CONFIGURATION side tab .
2. Press **Implement**.
3. Select from:
 - ▶ Machine Type [when available] – used to select the type of machine that most closely represents your machine
 - ▶ GNSS Antenna Height [when available] – used to measure the height of the antenna from the ground



- ▶ Implement Type – used to select the layout of the sections for the applied product location
 - ▶ Symmetric Implement – used to establish if sections are paired and therefore share the same width, offset, and length values
 - ▶ Number of Implement Sections – used to select the number of implement sections
 - ▶ Application Width [Straight or Staggered Implement Type] – used to enter the total width of all sections of the implement
 - ▶ Working Width [Spreader Implement Type] – used to enter the total width of the implement
 - ▶ Droplet Size Monitor [when available] – used to enable droplet size monitoring for up to five preselected sprayer tips
 - ▶ Tip Selection [Straight or Staggered Implement Type] – used to select the type of sprayer tip
 - ▶ BoomPilot Start Mode – used to establish whether BoomPilot will be controlled by speed or by the BoomPilot icon
 - ▶ BoomPilot Icon – used to activate the guidance screen icon for manually controlling on-screen application painting
4. Press NEXT PAGE arrow  to set up specific implement options. See the Implement chapter for details.
 5. Press RETURN arrow  or CONFIGURATION side tab  to return to the main Configuration screen.

Figure 1-7: Implement – Multiple Sections with SDM or SFM Setup



Droplet Size Monitor

When the system includes a Pressure Sensor Interface Kit (PSIK), Droplet Size Monitor can be enabled/disabled. The DSM then becomes available on the operation screens.

NOTE: For more information, see "Droplet Size Monitor" in the Implement chapter of this manual.



1. Press CONFIGURATION side tab .
2. Press **Implement**.
3. Select if Droplet Size Monitor is enabled or disabled. (If enabling, also read displayed information and press **Accept**.)
4. Press RETURN arrow  or CONFIGURATION side tab  to return to the main Configuration screen.

Figure 1-8: Droplet Size Monitor



Tip Selection

Tip Selection enables up to five (5) tips to be preset for quick recall, and the current tip to be selected.

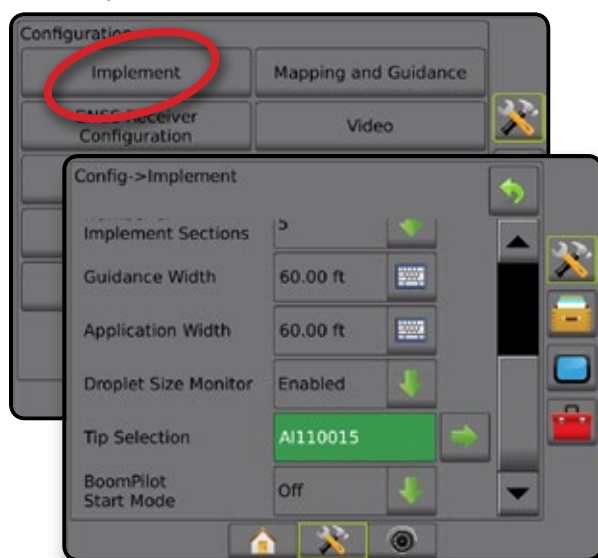
NOTE: For more information, see "Tip Selection" in the Implement chapter of this manual.





1. Press CONFIGURATION side tab .
2. Press **Implement**.
3. Press Tip Selection NEXT PAGE arrow .
4. Select from:
 - ▶ Tip Preset 1-5 – selects up to five (5) tips for quick recall, and selected the current tip for determining droplet size information
 - ▶ Current Tip – displays the current tip
5. Press RETURN arrow  or CONFIGURATION side tab  to return to the main Configuration screen.

Figure 1-9: Tip Selection



Reverse Sense Options

Reverse sense options are used when adding a Reverse sense module or SCM Pro (Steering Control Module Pro for FieldPilot Pro/ UniPilot Pro) to any configuration.. This allows for application mapping and control, and on-screen guidance when traveling in reverse.

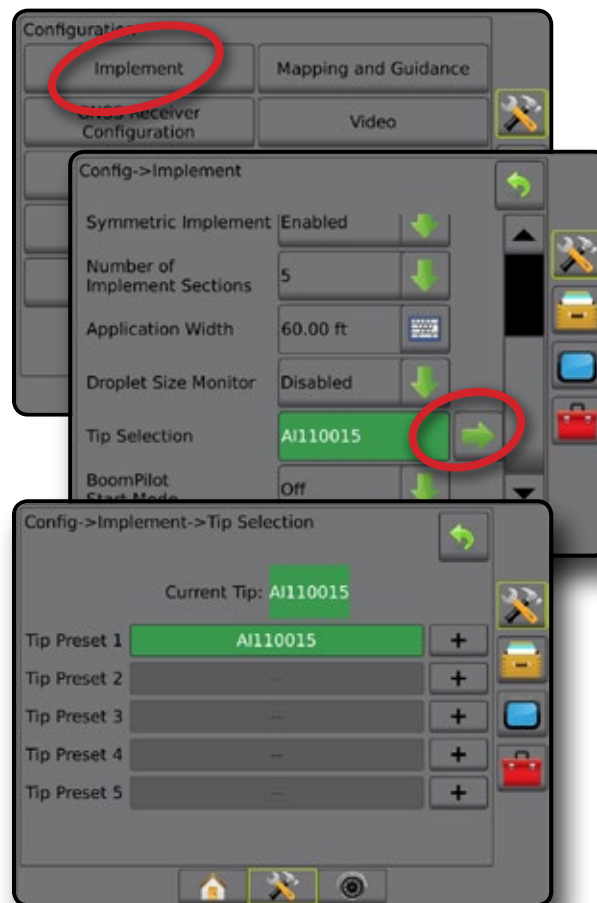
NOTE: For more information, see "Reverse Sense Module" in the Implement chapter of this manual.



1. Press CONFIGURATION side tab .
2. Press **Implement**.
3. Select:
 - ▶ Allow BoomPilot in Reverse [when available] – used to enable BoomPilot function while traveling in reverse
 - ▶ Reverse Signal Delay – used to set the delay when going from forward to reverse or reverse to forward, after which the vehicle icon on a navigation screen changes direction
4. Press RETURN arrow  or CONFIGURATION side tab  to return to the main Configuration screen.

Figure 1-10: Reverse Sense Options



Mapping and Guidance [Lightbar]

Mapping and guidance options are used to configure the mapping location, guidance width, cross track error shown on the lightbar. An optional External Lightbar Module (ELM) may be used to provide additional guidance information.

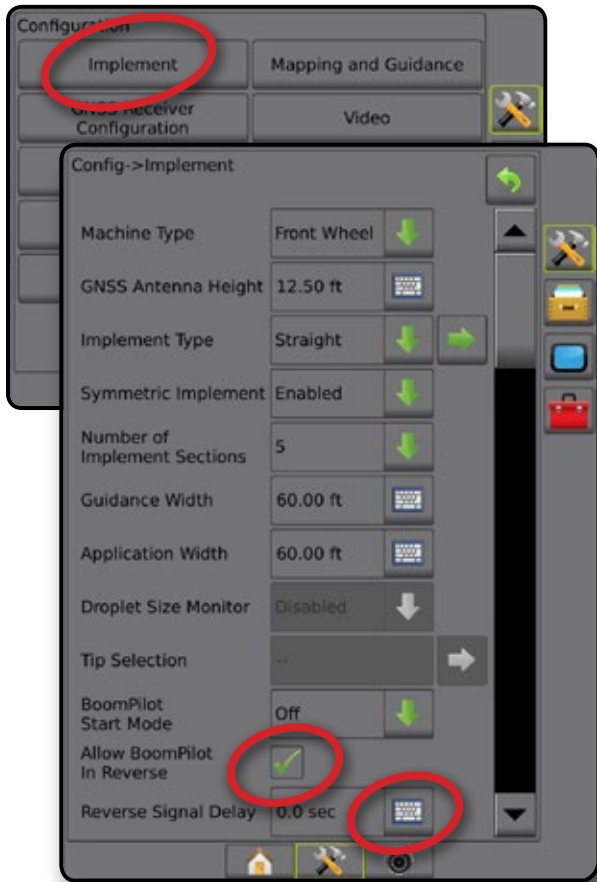
NOTE: In previous software versions, this feature was referred to as "Lightbar".

- Mapping and Guidance [console only] – used to configure the mapping location, guidance width and guidance sensitivity/ cross track error shown on the on screen guidance bar
- Mapping and Guidance [using an external lightbar] – used to configure an optional External Lightbar Module (ELM) which provides additional guidance information.

Figure 1-11: Mapping and Guidance



Mapping and Guidance [Console Only]

1. Press CONFIGURATION side tab .
2. Press **Mapping and Guidance**.
3. Select:
 - ▶ Mapping Location – establishes the layout of the location from which the boundary or polygon will be mapped.
 - Default Location – While creating an external boundary or polygon, the line will be to the exterior of the outermost active section. While creating an interior boundary, the line will be to the interior of the innermost active section. If no sections are active, the boundary will be marked to the end of the outermost section.
 - User Entry – in-line and lateral offset from the GNSS antenna directions and distances can be specified by the user. Up to five (5) user entries can be created. See "User Entered Mapping Location" for details.
 - ▶ Guidance Width – used to set the distance between guidelines
 - ▶ LED Brightness – used to adjust the brightness of the LEDs
 - ▶ Display Mode – used to determine whether the lightbar represents the swath or vehicle
 - When set to "swath", the LEDs represent guideline location and the moving LED represents the vehicle





- When set to "vehicle", the centre LED represents vehicle location and the moving LED represents the guideline
 - ▶ LED Spacing – used to set the distance away from the guideline or vehicle each illuminated LED represents
4. Press RETURN arrow  or CONFIGURATION side tab  to return to the main Configuration screen.

Figure 1-12: Mapping and Guidance

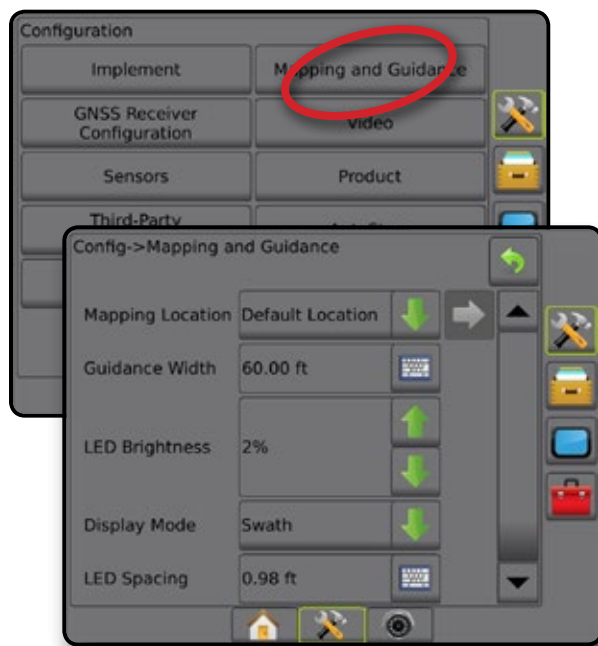

Mapping and Guidance Using an External Lightbar

Additional configuration options are available when using an external lightbar.

1. Press CONFIGURATION side tab .
2. Press **Mapping and Guidance**.
3. Select from:
 - ▶ Mapping Location – establishes the layout of the location from which the boundary or polygon will be mapped.
 - Default Location – While creating an external boundary or polygon, the line will be to the exterior of the outermost active section. While creating an interior boundary, the line will be to the interior of the innermost active section. If no sections are active, the boundary will be marked to the end of the outermost section.
 - User Entry – in-line and lateral offset from the GNSS antenna directions and distances can be specified by the user. Up to five (5) user entries can be created. See "User Entered Mapping Location" for details.
 - ▶ Guidance Width – used to set the distance between guidelines
 - ▶ LED Brightness – used to adjust the brightness of the LEDs on the console



- ▶ Display Mode – when External lightbar is "enabled", determines whether the lightbars represent the swath or vehicle
 - When set to "swath", the LEDs represent guideline location and the moving LED represents the vehicle
 - When set to "vehicle", the centre LED represents vehicle location and the moving LED represents the guideline
 - ▶ LED Spacing –
 - When External lightbar is "enabled", sets the distance away from the guideline or vehicle each illuminated LED represents
 - When External lightbar is "disabled", sets the distance around the guideline that is perceived as zero error
 - ▶ External lightbar – enable/disable use of the external lightbar
4. With the External Lightbar Module (ELM) enabled, select from:
- ▶ External Lightbar LED Brightness – adjusts the brightness of the external lightbar LEDs
 - ▶ External Lightbar Text Brightness – adjusts the brightness of the external lightbar text
 - ▶ External Cross Track – enable/disable display of cross track error information on the external lightbar
 - ▶ External Swath Number – enable/disable display of swath number information on the external lightbar
 - ▶ External Speed – enable/disable display of speed information on the external lightbar
 - ▶ External Actual Rate [available with Third-party Rate Control] – enable/disable display of actual rate information on the external lightbar
 - ▶ External Target Rate [available with Third-party Rate Control] – enable/disable display of target rate information on the external lightbar.
 - ▶ External Applied Product [available with Third-party Rate Control] – enable/disable display of applied product information on the external lightbar
5. Press RETURN arrow  or CONFIGURATION side tab  to return to the main Configuration screen.

Figure 1-13: Mapping and Guidance with External Lightbar







- ▶ Mapping Location In-line Offset Distance – used to define the in-line distance from the GNSS antenna to the mapping location
 - ▶ Mapping Location Lateral Offset Direction – used to select the lateral direction from the centerline of the machine to the mapping location while facing in the machine's forward direction
 - ▶ Mapping Location Lateral Offset Distance – used to define the lateral distance from the centerline of the machine to the mapping location
6. Press RETURN arrow  to return to the Mapping and Guidance screen or CONFIGURATION side tab  to return to the main Configuration screen.

Figure 1-14: User Entered Mapping Location

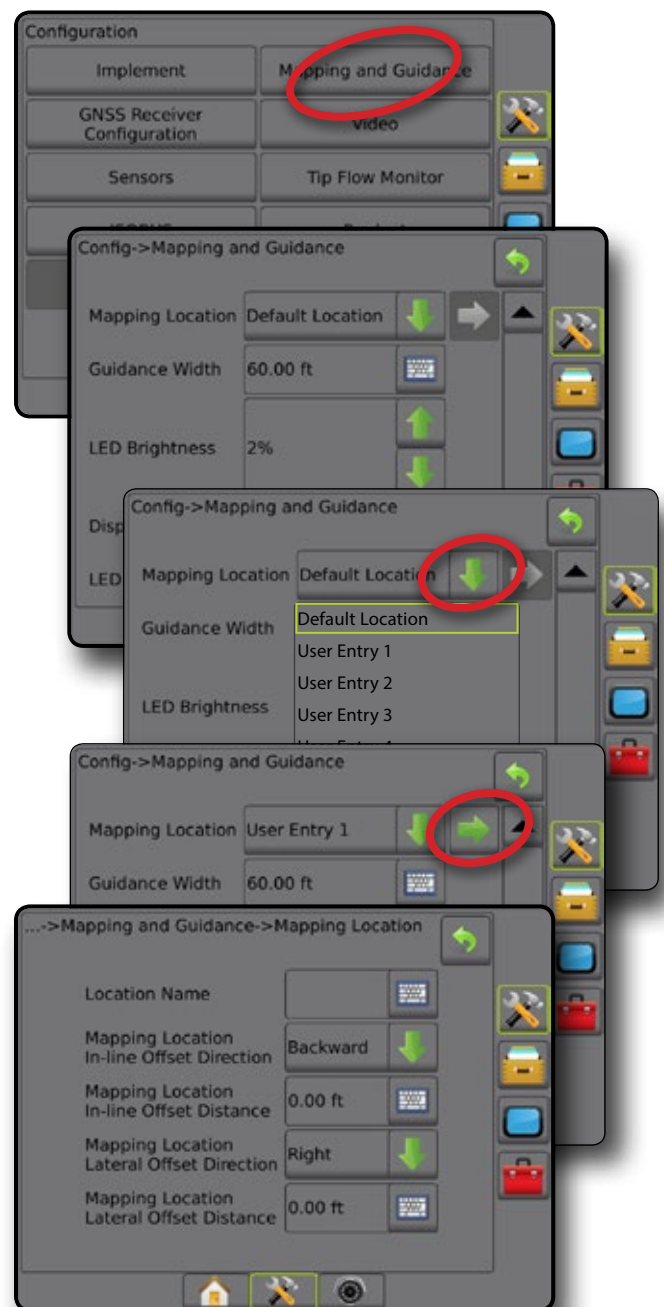

User Entered Mapping Location

Mapping location establishes the location from which boundary and polygon mapping will take place.

1. Press CONFIGURATION side tab .
2. Press **Mapping and Guidance**.
3. Select user entry location from the Mapping Locations drop-down options.
4. Press MAPPING LOCATION NEXT PAGE arrow  to set up the selected specific mapping location options.
5. Select:
 - ▶ Location Name – used to enter the name of the mapping location for the current user entry selected
 - ▶ Mapping Location In-line Offset Direction – used to select whether the mapping location is located in front of or behind the GNSS antenna as the vehicle moves in a forward direction

GNSS Receiver Configuration

GNSS Receiver Configuration is used to configure GNSS Type, GNSS Port, and PRN, as well as to view GNSS status information.

NOTE: For more information, see the GNSS Receiver Configuration chapter of this manual.

These settings are required for assisted/auto steering, tilt sensor operation, and rate control functionality, as well as proper implement operation.





1. Press CONFIGURATION side tab .
2. Press **GNSS Receiver Configuration**.
3. Select from:
 - ▶ GNSS Type – sets to accept GNSS source transmissions: GPS, GLONASS, SBAS (with or without DGPS Required)
 - ▶ GNSS Port – sets GNSS communication port to either Internal or External
 - ▶ GNSS Status Information – displays current GNSS status information
 - ▶ Program – only TeeJet support technicians should use this feature
 - ▶ PRN – selects the first of two possible SBAS PRN's to provide SBAS correction data. Set to **Automatic** for automatic PRN selection.
 - ▶ Alternate PRN – when PRN is not automatic, allows possible selection of a second SBAS PRN to provide correction data
 - ▶ Show refresh GNSS position button – establishes if the refresh GNSS position button is available on the guidance screens.
4. Press NEXT PAGE arrow  to set up the selected specific GNSS options.
5. Press RETURN arrow  or CONFIGURATION side tab  to return to the main Configuration screen.

Figure 1-15: GNSS Receiver Configuration Options



PRN Not Shown

PRN options are only available with SBAS GNSS Type selected.

Video

Video Setup is used to set up a single directly connected camera or individual cameras while using an Eight (8) Channel or Four (4) Channel Video Selector Module (VSM). Up to 8 cameras can be configured if a VSM is installed.

1. Press CONFIGURATION side tab .
2. Press **Video**.
3. Select the appropriate check box(es):
 - ▶ Reverse – **CBA**
 - ▶ Upside Down – **VBC**



For normal video view **ABC** un-check all check boxes.
4. Press RETURN arrow  or CONFIGURATION side tab  to return to the main Configuration screen.

Figure 1-16: Video with 4 Channel VSM Options



Video Setup Unavailable

If a camera or VSM is not connected, setup options will not be available.

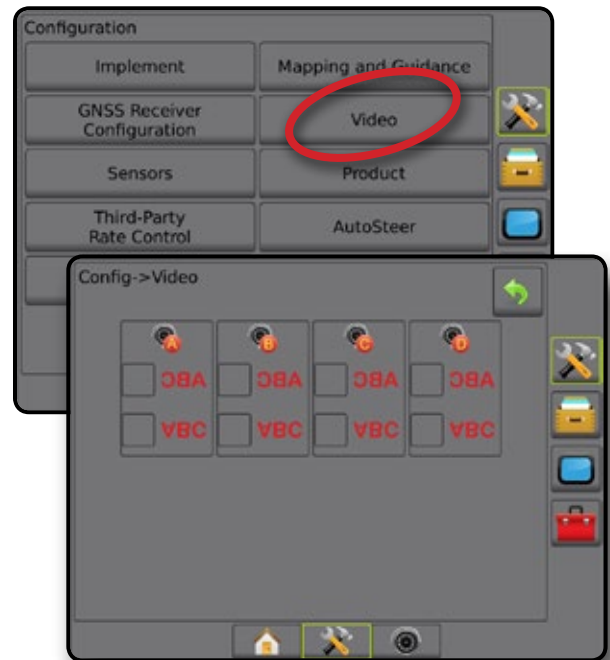
Sensors

When a Pressure Sensor Interface Kit (specifically, an Input Output Module (IOM)) is on the system, options to set up and configure the sensor will be available.

1. Press CONFIGURATION side tab .
2. Press **Sensors**.

Figure 1-17: Sensors



The Pressure Sensor Interface Kit is recognized on the Console About screen as an Input/Output Module (IOM).

Figure 1-18: Input/Output Module

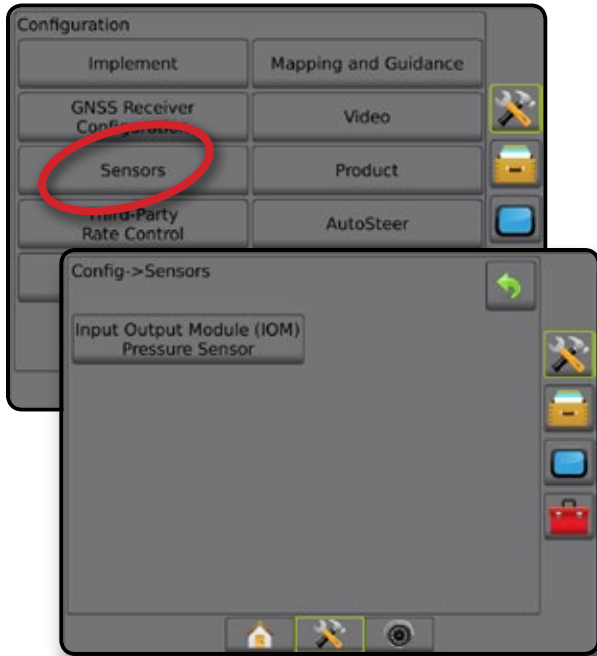
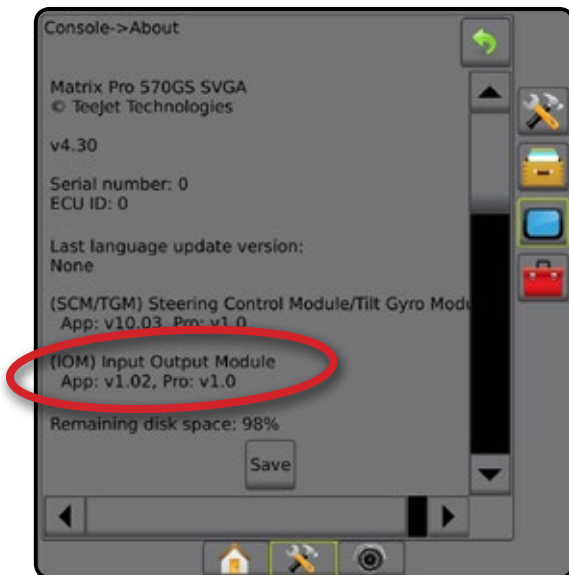

Sensors Unavailable

If a Pressure Sensor Interface Kit is not installed, setup options will not be available.

Input/Output Module Pressure Sensor

When a Pressure Sensor Interface Kit is present, Pressure Sensor options are used to enter the sensor manufacturer's maximum pressure rating and set high and low user determined pressure alarms.



1. Press CONFIGURATION side tab .
2. Press **Sensors**.
3. Press **Input Output Module (IOM) Pressure Sensor**.
4. Select from:
 - ▶ Maximum Pressure Rating – used to establish the maximum pressure rating of the pressure sensor as recommended by the manufacturer
 - ▶ Low Pressure Alarm – used to enter the user determined low pressure point at which the alarm will sound
 - ▶ High Pressure Alarm – used to enter the user determined high pressure point at which the alarm will sound
5. Press RETURN arrow  or CONFIGURATION side tab  to return to the main Configuration screen.

Figure 1-19: Input/Output Monitor Pressure Sensor Options



Droplet Size Monitor

If a Pressure Sensor Interface Kit is being used, the Droplet Size Monitor options will be available.



1. Press CONFIGURATION side tab .
2. Press **Implement**.
3. Press **Droplet Size Monitor**.
4. Select if droplet size monitor is enabled or disabled.
5. Press RETURN arrow  or CONFIGURATION side tab  to return to the main Configuration screen.

Figure 1-20: Droplet Size Monitor



Product

When a Third-Party Rate Control system is present and Rate Control has been unlocked, Product options are available for configuring product control channel names and maximum/minimum rate limits and corresponding display colors for mapping.

See the Rate Control chapter of this manual for more details.

Figure 1-21: Product Options

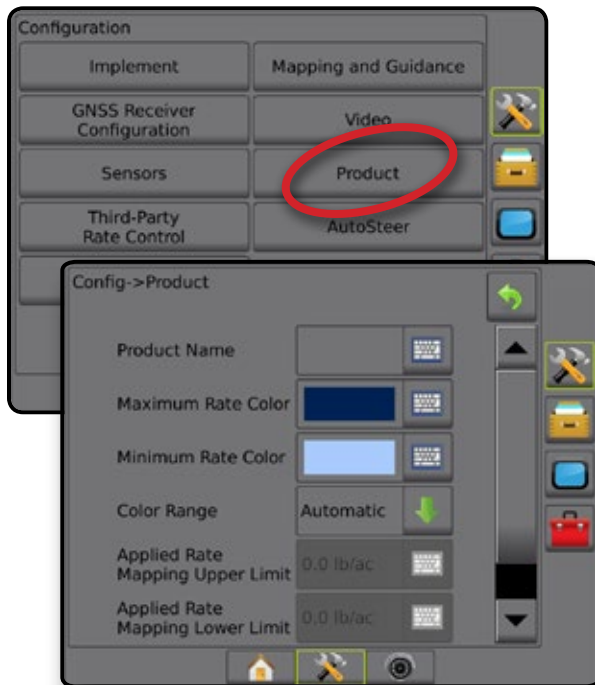

Third-Party Rate Control

When a Third-Party Rate Control system is present and Rate Control has been unlocked, a Third-party rate control can be enabled/disabled.

See the Rate Control chapter of this manual for more details.

Figure 1-22: Third-Party Rate Control



AutoSteer

When a Steering Control Module (SCM or SCM Pro) is present, Assisted/Auto Steering options will be available.

NOTE: For detailed setup instructions, refer to your specific assisted/auto steering installation manual.

AutoSteer setup is used to enable/disable and calibrate assisted/auto steering.

- FieldPilot [using a SCM] – used to establish valve setup settings, steering settings, steering wheel and steering angle sensor settings, and to perform valve tests or valve diagnostics
- FieldPilot Pro / UniPilot Pro [using a SCM Pro] – used to manage vehicle settings, calibrate sensors, select QI values, as well as establish transport mode and service mode

Figure 1-23: AutoSteer

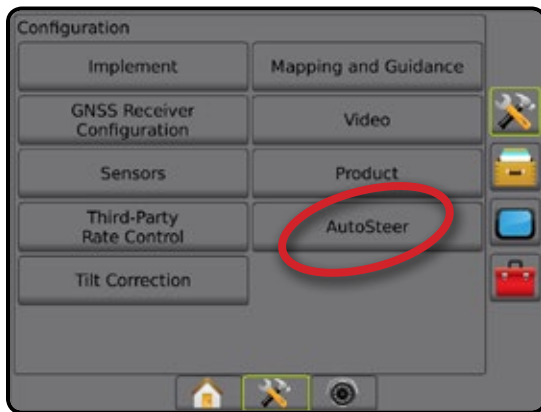

Assisted/Auto Steering Unavailable

If an assisted/auto steering system is not installed, setup options will not be available.

Figure 1-24: Assisted/Auto Steering Not Detected

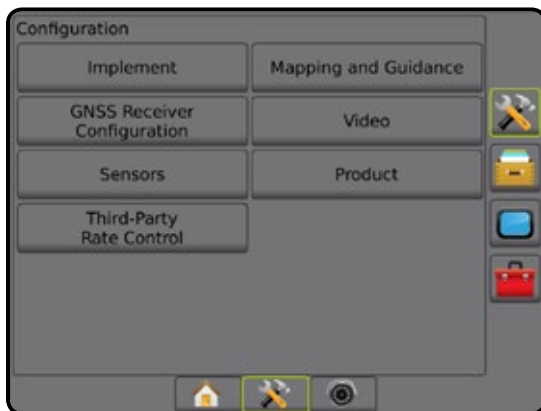

FieldPilot [using a SCM]

1. Press CONFIGURATION side tab .
2. Press **AutoSteer**.
3. Select if assisted/auto steering is enabled or disabled.
4. When enabled, select from:

- ▶ Valve Setup – used to configure Valve Type, Valve Frequency, Minimum Duty Cycle Left/Right and Maximum Duty Cycle Left/Right
- ▶ Steering Settings – used to establish Coarse Steering Adjustment, Fine Steering Adjustment, Deadband, and Lookahead
- ▶ Valve Test – used to verify if steering is directed correctly
- ▶ Valve Diagnostics – used to test the valves to see if they are connected properly
- ▶ Options: Steering Wheel Sensor – used to select whether the steering disengage sensor is magnetic or pressure sensor based
- ▶ Steering Angle Sensor – used to establish and calibrate the Steering Angle Sensor (SAS) as the primary feedback sensor for auto steering



5. Press RETURN arrow  or CONFIGURATION side tab  to return to the main Configuration screen.

Figure 1-25: AutoSteer



FieldPilot Pro / UniPilot Pro [using a SCM Pro]

1. Press CONFIGURATION side tab .
2. Press **AutoSteer**.
3. Select from:
 - ▶ Manage Vehicles – allows the operator to select, edit, copy, delete, or export/import vehicle profiles as well as perform a vehicle and sensor calibration for the current vehicle; perform tilt calibration only (this option is available only after the active vehicle has completed the initial calibration); and make adjustments to steering response, line acquisition, heading aggressiveness, reverse response and motor aggressiveness (for UniPilot Pro).

NOTE: When creating a new vehicle profile or editing an existing vehicle profile, Manual Disengage should be set up before doing the Automatic Calibration.

- ◀ New ❶ – creates a new vehicle profile.
- ◀ Load – activates the highlighted vehicle profile.
- ◀ Edit ❷ – allows the operator to modify the parameters of the active vehicle profile including Wheel Base, Antenna In-line Offset Direction & Distance, Antenna Lateral Offset Direction & Distance, Antenna Height, SCM Pro In-line Offset Direction & Distance, SCM Pro Lateral Offset Direction & Distance, SCM Pro Height, and SCM Pro Orientation

- ◀ Copy – duplicates the active vehicle profile
- ◀ Automatic Calibration ❸ – guides the operator through the calibration process for the active vehicle. The calibration steps teach the FieldPilot Pro system or UniPilot Pro system the characteristics of the vehicle and the steps are critical to achieve optimal control performance.

- ◀ Adjust – after the vehicle has been calibrated, it should perform adequately for most normal field operations. However in some situations, it may be necessary to adjust the steering performance to take into account field conditions, implement selection, traveling speed, etc. The Vehicle Adjust screen enables the operator to adjust the vehicle steering performance to match these changing conditions.

- Manual Disengage ❹ – adjust the limit at which FieldPilot Pro or UniPilot Pro is disengaged when the steering wheel is being turned manually.

- ◀ Delete – allows the operator to delete a vehicle profile that is no longer needed. The active vehicle profile cannot be deleted.

- ▶ Select QI Values – allows the user to configure the minimum GNSS position quality (precision level) requirements to allow FieldPilot Pro or UniPilot Pro to be activated and remain engaged

- ▶ Maximum DOP – Maximum DOP (Dilution of Precision) sets the maximum value of the overall quality of a GNSS position based on the satellite geometry that is used to calculate it. A value of 1 to 2 is excellent, 2-5 is good, 5-10 is moderate, 10-20 is fair, and anything over 20 is poor.

Assisted/automatic steering should be performed when the DOP is below 4 for best results.

- ▶ Transport Mode – when enabled, all AutoSteer functions are disabled and cannot be activated.
- ▶ Service Mode – when enabled, WiFi will be available through the next power cycle so a technician can connect to the SCM Pro directly for service tasks.

- ▶ Operator Presence – set Operator Presence Switch response
 - Enable – FieldPilot Pro or UniPilot Pro not possible with switch OPEN. Recommended setting regardless of presence/absence of Operator Presence switch.
 - Disable – Operator Presence detection has been deactivated and will not affect FieldPilot Pro or UniPilot Pro. This is a critical safety feature that should only be disabled when instructed by the machine manufacturer or TeeJet Technologies.

4. Press RETURN arrow ↩ or CONFIGURATION side tab 🛠 to return to the main Configuration screen.

Active Vehicle

Active Vehicle is highlighted with a set of asterisks (*). This is the vehicle profile the FieldPilot Pro system or UniPilot Pro system is currently programmed to use.



Figure 1-26: FieldPilot Pro or UniPilot Pro Setup Opening Screen



Tilt Correction

When a Steering Control Module (SCM) or Tilt Gyro Module (TGM) is present, Tilt Correction is available. This corrects the GNSS signal to compensate for errors in the GNSS position while operating on hilly or sloped terrain.

For detailed setup instructions, refer to your specific assisted/auto steering installation manual or tilt setup bulletin.

1. Press CONFIGURATION side tab .
2. Press **Tilt Correction**.
3. Select if Tilt Correction is enabled or disabled.
4. When enabled, select **Field Level** to calibrate tilt correction.
5. Press RETURN arrow  or CONFIGURATION side tab  to return to the main Configuration screen.

NOTE: If FieldPilot or UniPilot is being used, a Tilt Gyro Module is built into the system. When using a FieldPilot Pro or UniPilot Pro, tilt correction is calibrated under Setup-> Configuration-> AutoSteer-> Manage vehicles-> Adjust-> Tilt calibration.

NOTE: Antenna Height must be entered prior to Tilt Calibration.

Figure 1-27: Tilt Correction



Field Level Unavailable

If the vehicle is in motion, the field level option will not be available. Vehicle must be stopped for at least 10 seconds to begin to calibrate tilt correction.

Tilt Correction Unavailable

If an SCM or TGM is not connected, setup options will not be available. When using a FieldPilot Pro or UniPilot Pro, tilt correction is calibrated under Setup-> Configuration-> AutoSteer-> Manage vehicles-> Adjust-> Tilt calibration.

DATA MANAGEMENT

Data Management allows for transfer and management of job data, reporting of job data, changing of job mode, and transfer and management of machine settings.



1. Press SYSTEM SETUP bottom tab .
2. Press DATA MANAGEMENT side tab .
3. Select from:
 - ▶ Job Data – in advanced job mode, used to transfer job information (delete, import, export) and manage job information (create a new job, delete a job, or copy a job's Guidelines, Boundaries, Applied Data, Prescription Map and/or polygons to a new job)
 - ▶ Reports – used to create job reports and save them to a USB drive
 - ▶ Options – used to select simple job mode or advanced job mode
 - ▶ Machine Settings – used to transfer machine settings (delete, import, export) and manage machine setting (create a new machine setting, copy a machine setting, delete a machine setting, save the current machine setting to the selected file, or load the selected file's machine setting)

Figure 1-28: Data Management Options



Job Data

When in advanced job mode, job data options are used to transfer job information (delete, import, export) and manage job information (create a new job, delete a job, or copy a job's Guidelines, Boundaries, Applied Data, Prescription Map and/or polygons to a new job).

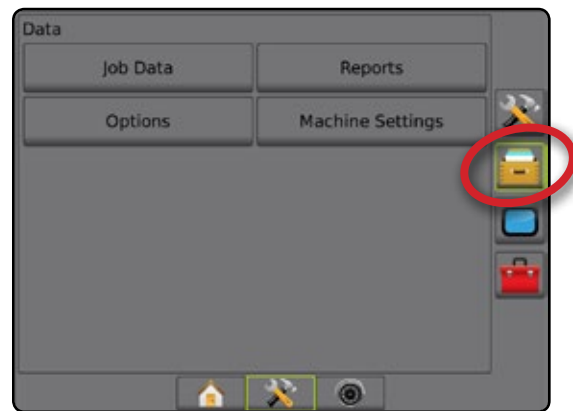
Job Data includes:

- Job name
- Client, Farm, and Field names
- Boundary (external, internal)
- Polygons
- Coverage Area
- Guidelines
- Maps (Coverage, Prescription, Application, Preset Target Rate)



1. Press DATA MANAGEMENT side tab .
2. Press **Job Data**.
3. Select from:
 - ▶ Transfer – when in advanced job mode, allows the transfer of selected jobs to or from a USB drive, as well as deleting jobs
 - ▶ Manage – when in advanced job mode, allows the creation of a new empty job, copying of a selected job's Guidelines, Boundaries, Applied Data, Prescription Map and/or polygons to a new job, as well as deleting a selected job
4. Press RETURN arrow  or DATA MANAGEMENT side tab  to return to the main Data Management screen.

Figure 1-29: Job Data Options



Job Data Unavailable

When in simple job mode, job data options will not be available.

Figure 1-30: Job Data Unavailable

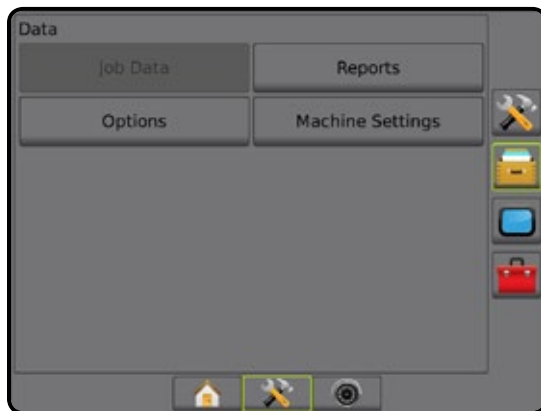

Transfer

When in advanced job mode, the job data transfer screen allows the transfer of selected jobs to or from a USB drive, as well as deleting jobs.

Jobs transferred to a USB storage device can be opened and updated using Fieldware Link. In Fieldware Link a user can input client, farm and field data as well as copy/edit jobs for reuse of boundaries and guidelines. From Fieldware Link, jobs can be ported back to a USB storage device to be moved back onto the console internal storage for use.

NOTE: When a job is active/started, Transfer options are not available for selection. Stop the current job to enable the function.

Jobs transferred to a storage device are removed from the console and are no longer available for use.







1. Press DATA MANAGEMENT side tab .
2. Press **Job Data**.
3. Press **Transfer**.
4. Select from:
 - ▶ Move Job Data to USB Storage  – used to move job data from internal storage to USB storage
 - ▶ Move Job Data to Internal Storage  – used to move job data from USB storage to internal storage
 - ▶ Delete Job Data  – used to delete job data from internal storage
5. Press RETURN arrow  or DATA MANAGEMENT side tab  to return to the main Data Management screen.

Figure 1-31: Job Data – Transfer



Manage

When in advanced job mode, the job data manage screen allows the creation of a new empty job, copying of a selected job's Guidelines, Boundaries, Applied Data, Prescription Map and/or polygons to a new job, as well as deleting a selected job.

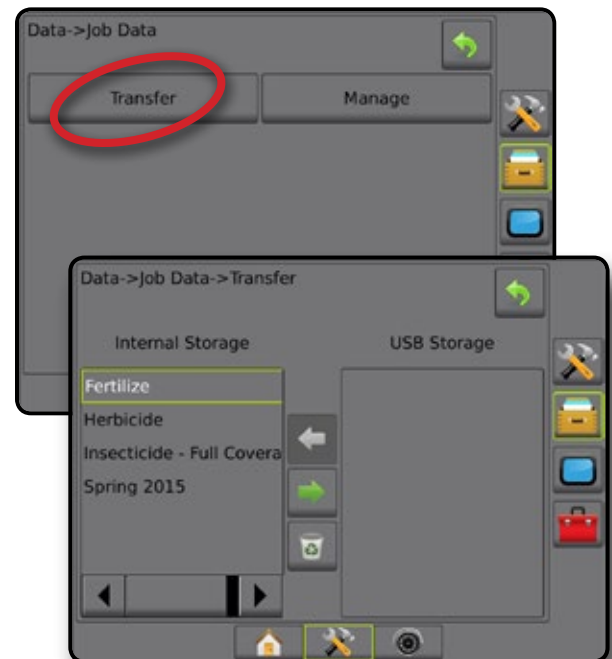
NOTE: When a job is active/started, Manage options are not available for selection. Stop the current job to enable the function.



1. Press DATA MANAGEMENT side tab .
2. Press **Job Data**.
3. Press **Manage**.
4. Select from:
 - ▶ New – used to create a new empty job with no associated Guidelines, Boundaries, Applied Data, or Prescription Map
 - ▶ Copy – used to copy the selected job's Guidelines, Boundaries, Applied Data, Prescription Map and/or polygons into a new job
 - ▶ Delete – used to delete job data from internal storage
5. Press RETURN arrow  or DATA MANAGEMENT side tab  to return to the main Data Management screen.

Figure 1-32: Job Data – Manage



NOTE: Copying applied data is not recommended as the user will end up with two copies that can be changed. When backing up data, it is best to transfer the Job to Fieldware Link and make a backup of the catalog.

Copy Job Data

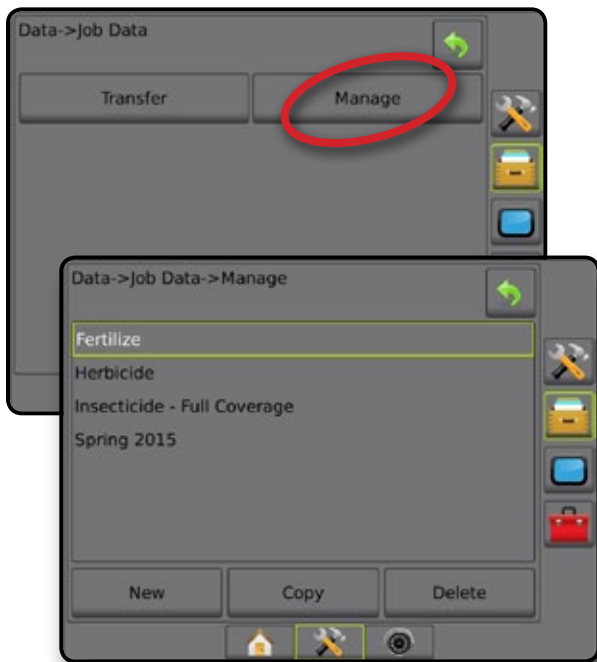
When in advanced job mode, the copy job data option is used to duplicate job information (guidelines, boundaries, applied data, prescription map and/or polygons) to a new job.

1. Press DATA MANAGEMENT side tab .





2. Press **Job Data**.
3. Press **Manage**.
4. Press **Copy**.
5. Select the job's guidelines, boundaries, applied data, prescription map and/or polygons to be copied into a new job.
6. Press **Copy**.
7. Name the new job.
8. Press the ACCEPT icon  to save the new job or the CANCEL icon  to leave the keyboard without saving.
9. Press RETURN arrow  or DATA MANAGEMENT side tab  to return to the main Data management screen

Figure 1-33: Job Data – Copy Data









Reports

Reports provides options for generating a report of the Job data in three different formats and save them to a USB drive.

NOTE: If Simple Job Mode is selected in the Options page, only the current job can be saved.

When a job is active/started, Reports are not available for selection. Stop the current job to enable the function.

When closing a job with a USB drive in the console, you get the option to create a report on the current job.

1. Press DATA MANAGEMENT side tab .
2. Press **Reports**.
3. Insert a USB drive into the console.
4. Select the job to be saved.
5. Select:
 - ▶ PDF  – report for print
 - ▶ KML  – Google Earth Map
 - ▶ SHP  – ESRI shape data
 - ▶ ALL  – all available file types
6. Press RETURN arrow  or DATA MANAGEMENT side tab  to return to the main Data Management screen.





NOTE: The file icons     or buttons are not available for selection (grayed out) until a USB drive is inserted properly.

Figure 1-34: Reports – Advanced Job Mode

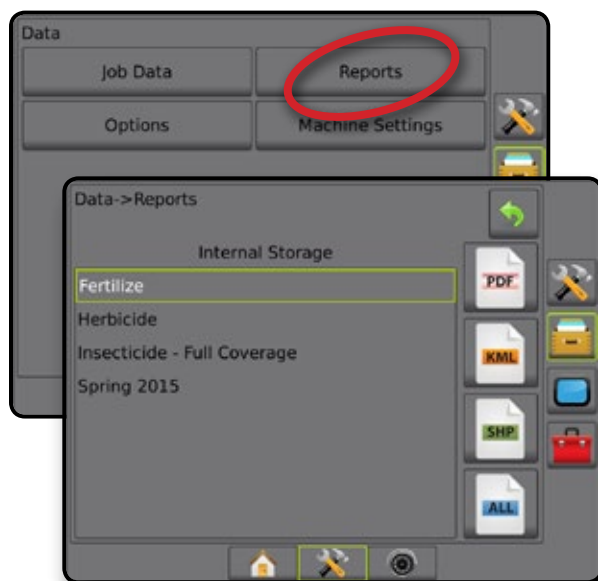
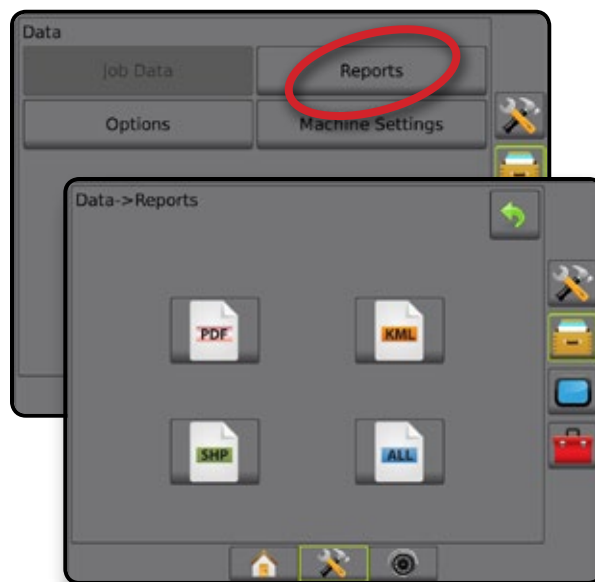

Figure 1-35: Reports – Simple Job Mode





Options (Job Mode)

Options allows the operator to select between Simple or Advanced Job Mode.

NOTE: When a job is active/started, changing the job mode is not available. Stop the current job to enable the function.

WARNING! Changing job modes deletes all internal job data.

1. Press DATA MANAGEMENT side tab .
2. Press **Options**.
3. Press DOWN arrow  to access the list of options.
4. Select:
 - ▶ Simple – only bounded area and coverage areas are displayed on the home screen. Only the current job is available for saving in Reports. Use with Fieldware Link is not available.
 - ▶ Advanced – more than one job will be available at any time. Client, farm, field and job names; bounded and coverage areas; application time; and distance from selected job are displayed on the home screen. All saved job profiles can be exported as a PDF, SHP or KML file to a USB drive using Data -> Reports.
 - Client information, farm information, field information, and prescription maps can only be inputted using Fieldware Link. A job name can only be edited using Fieldware Link.
 - A user can duplicate jobs for reuse of guidelines, boundaries, applied data, prescription map, and/or polygons using Fieldware Link or Data -> Job Data -> Manage in the console.

5. "Changing job modes requires deleting all job data. Do you wish to change modes?"

Press:

- ▶ Yes – to make the change
- ▶ No – to keep the current setting



6. Press RETURN arrow  or DATA MANAGEMENT side tab  to return to the main Data Management screen.

Figure 1-36: Options – Change Job Mode



Machine Settings

The Machine Settings menu is used to create and manage individual Machine Profiles representing the configuration of the console on a particular vehicle/equipment setup. Each Machine Profile records the settings in use at the time the profile is generated allowing the customer to recall their exact setup for later use. Machine Profiles can be used to transfer settings to another console of the same make and model with the same attached hardware.

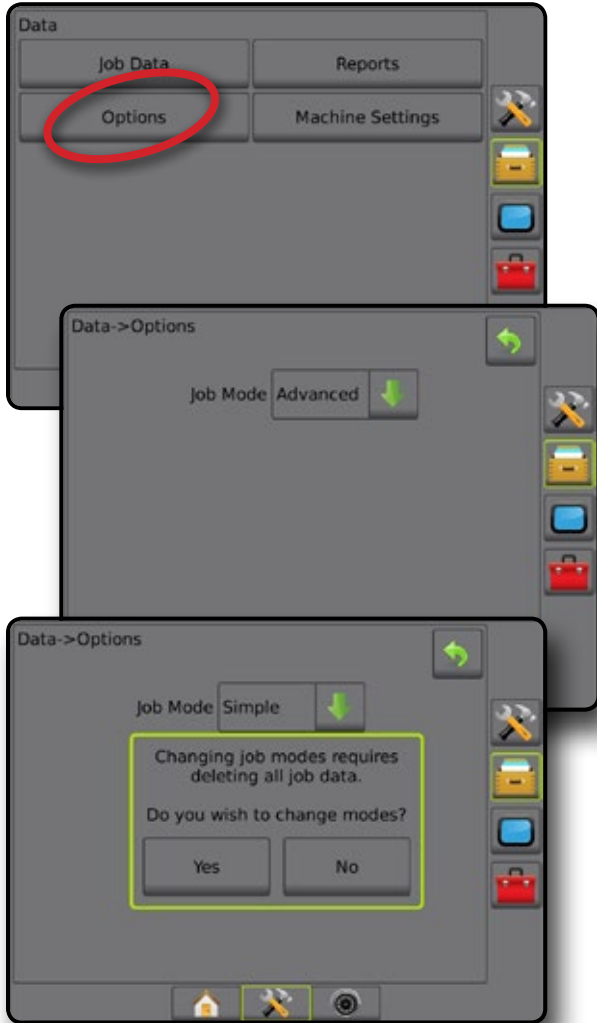
Machine Settings include:

- Implement settings
- AutoSteer/Tilt Correction settings
- Rate Control settings
- Job-specific settings (including application rates, application type, and Product Channel assignments)

NOTE: Not all settings are saved as part of the machine settings. See the appendix "Matrix Pro GS Console Menu Settings" for details.



1. Press DATA MANAGEMENT side tab .
2. Press **Machine Settings**.
3. Select from:
 - ▶ Transfer – allows the transfer of selected machine settings to or from a USB drive, as well as deleting machine settings
 - ▶ Manage – allows the creation of a new empty machine settings, the copying of a selected machine settings to a new machine settings, the deletion of a selected machine settings, the saving of the current machine settings to the selected machine settings, or the loading of the selected machine settings to the current settings
4. Press RETURN arrow  or DATA MANAGEMENT side tab  to return to the main Data Management screen.

Figure 1-37: Machine Settings



Transfer

The machine settings transfer screen allows the transfer of selected machine settings to or from a USB drive, as well as deleting machine settings.

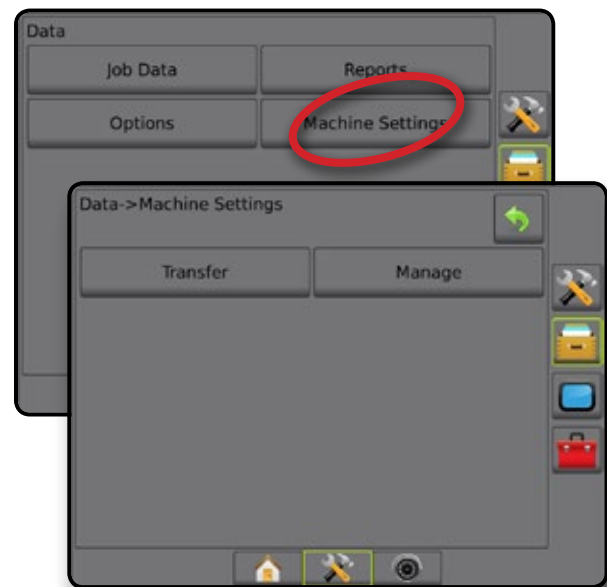
Machine settings transferred to a USB storage device can be opened and updated using Fieldware Link. From Fieldware Link, machine settings can be ported back to a USB storage device to be moved back onto the console internal storage for use.

NOTE: Not all settings saved as part of the machine settings are available to be edited in Fieldware Link. See the appendix "Matrix Pro GS Console Menu Settings" for details.

Machine settings transferred to a storage device are removed from the console and are no longer available for use.







1. Press DATA MANAGEMENT side tab .
2. Press **Machine Settings**.
3. Press **Transfer**.
4. Select from:
 - ▶ Move Machine Settings to USB Storage  – used to move machine settings from internal storage to USB
 - ▶ Move Machine Settings to Internal Storage  – used to move machine settings from USB to internal storage
 - ▶ Delete Machine Settings  – used to delete machine settings from internal storage or USB storage
5. Press RETURN arrow  or DATA MANAGEMENT side tab  to return to the main Data Management screen.

Figure 1-38: Machine Settings – Transfer



Manage

The Machine Settings Manage screen allows the creation of a new empty machine settings, the copying of a selected machine settings to a new machine settings, the deletion of a selected machine settings, the saving of the current machine settings to the selected machine settings, or the loading of the selected machine settings to the current settings.

NOTE: Not all settings are saved as part of the machine settings. See the appendix "Matrix Pro GS Console Menu Settings" for details.



1. Press DATA MANAGEMENT side tab .
2. Press **Machine Settings**.
3. Press **Manage**.
4. Select from:
 - ▶ New – used to create a new machine setting with no associated implement information
 - ▶ Copy – used to copy a selected machine settings into a new machine settings
 - ▶ Delete – used to delete a selected machine settings from internal storage
 - ▶ Save – used to save the current machine settings to the selected machine settings
 - ▶ Load – used to load the selected machine settings to the current settings
5. Press RETURN arrow  or DATA MANAGEMENT side tab  to return to the main Data Management screen.

Figure 1-39: Machine Settings – Manage



Copy Machine Profile

The copy machine profile option is used to duplicate the selected machine profile for recall of that profile at a later use. Machine profiles can be used to transfer settings to another console of the same make and model with the same attached hardware.

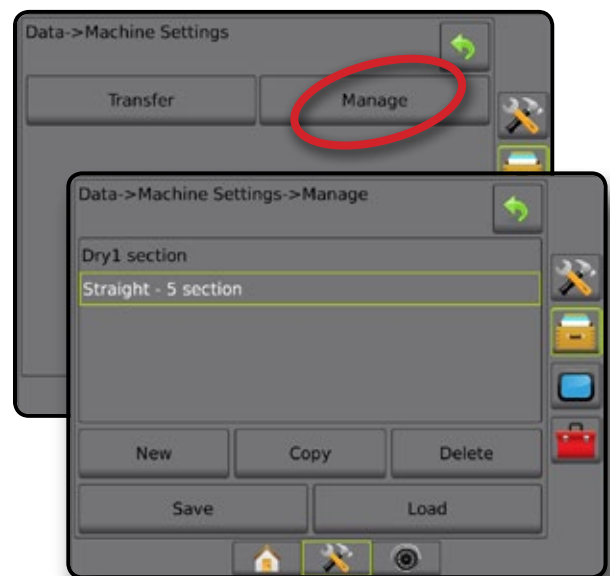



1. Press DATA MANAGEMENT side tab .
2. Press **Machine settings**.
3. Press **Manage**.
4. Select the machine profile to be copied into a new profile.
5. Press **Copy**.
6. Name the new profile.
7. Press the ACCEPT icon  to save the new profile or the CANCEL icon  to leave the keyboard without saving.
8. Press RETURN arrow  or DATA MANAGEMENT side tab  to return to the main Data management screen

Figure 1-40: Machine Settings – Copy Profile



CONSOLE

Console Setup is used to configure the display and cultural settings, unlock advanced features and play back demo GNSS data. Information about other devices attached to the system can be found in the About section.



1. Press SYSTEM SETUP bottom tab .
2. Press CONSOLE side tab .
3. Select from:
 - ▶ About – used to display the system software version as well as the software versions of modules connected to the CAN bus
 - ▶ Display – used to configure color scheme and LCD brightness, establish screenshot availability, and calibrate the touchscreen
 - ▶ Cultural – used to configure units, language, and time zone settings
 - ▶ Audio Volume – used to adjust the volume level of the audio speaker
 - ▶ Demo GNSS – used to start playback of simulated GNSS data
 - ▶ Feature Unlock – used to unlock advanced features



Figure 1-41: Console Options

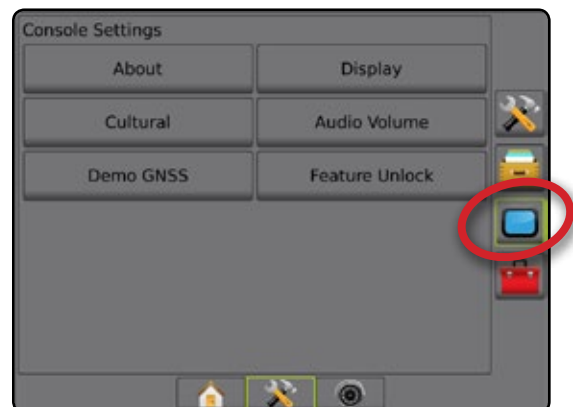

About

About/Save screen displays the system software version as well as the software versions of modules connected to the CAN bus.

To aid when troubleshooting problems in the field, an end user can use the Save button to download a text file containing current software information to a USB drive, then e-mail the file to support personnel.

1. Press CONSOLE side tab .
2. Press **About**.
3. Select from:
 - ▶ View Information including Unit Serial Number, Software Version, and Connected Modules
 - ▶ With a USB drive in the console, press **Save** to save the About information to the USB drive. Saved version information to USB drive will confirm the save.
4. Press RETURN arrow  or CONSOLE side tab  to return to the main Console Settings screen.

NOTE: The **Save** option is not available for selection (grayed out) until a USB drive is inserted properly.

Figure 1-42: About Options

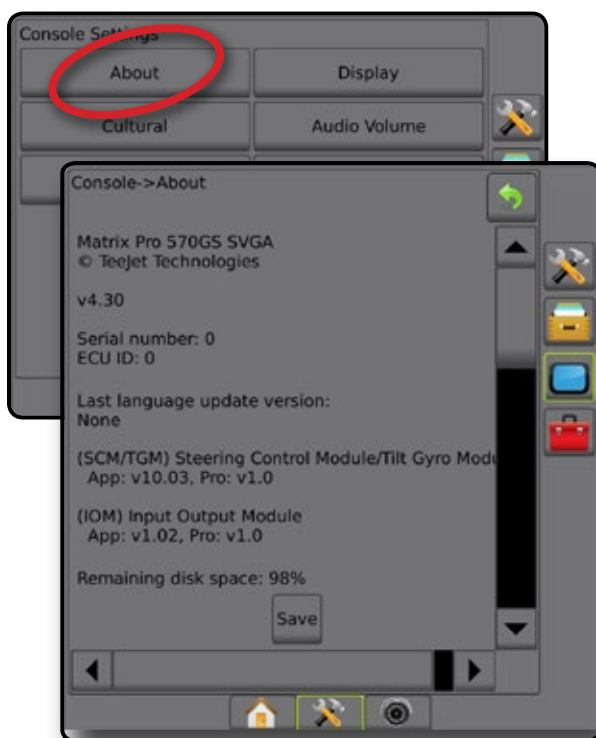

Display

Display is used to configure color scheme and LCD brightness, establish screenshot availability and calibrate the touchscreen.



1. Press CONSOLE side tab .
2. Press **Display**.
3. Select from:
 - ▶ Color Scheme – used to choose the color scheme that is easiest to read
 - ▶ LCD Brightness – used to adjust the brightness of the console display
 - ▶ Screenshot – used to allow screen captures to be saved to a USB drive
 - ▶ Screen Calibration – used to calibrate the touch screen
4. Press RETURN arrow  or CONSOLE side tab  to return to the main Console Settings screen.

Figure 1-43: Display Options



Cultural

Cultural is used to configure units, language, and time zone settings.

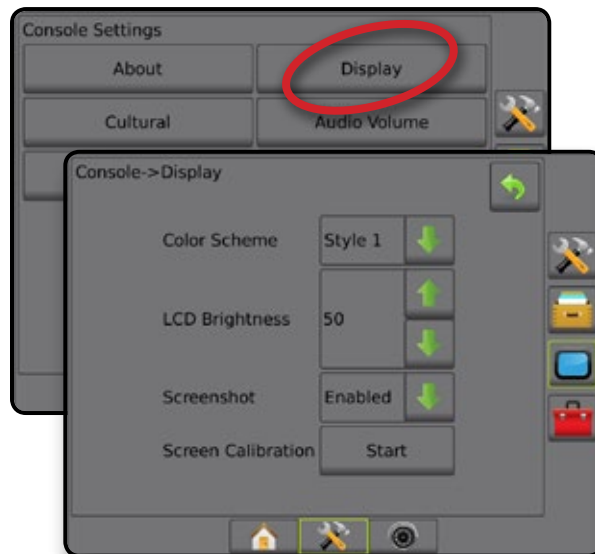

1. Press CONSOLE side tab .
2. Press **Cultural**.
3. Select from:
 - ▶ Units – used to define the system units
 - ▶ Language – used to define the system language
 - ▶ Time Zone – used to establish the local time zone
4. Press RETURN arrow  or CONSOLE side tab  to return to the main Console Settings screen.

Figure 1-44: Cultural Options



Audio Volume

Audio Volume adjusts the volume level of the audio speaker.





1. Press CONSOLE side tab .
2. Press **Audio Volume**.
3. Press:
 - ▶ UP arrow  to increase the sound
 - ▶ DOWN arrow  to soften the sound
4. Press RETURN arrow  or CONSOLE side tab  to return to the main Console Settings screen.



Figure 1-45: Audio Volume Options



Demo GNSS

Demo GNSS is used to start the playback of a simulated GNSS signal.

WARNING! This tool will disable incoming GNSS positions and begin playing back simulated data. A console reboot is necessary in order to restore real GNSS.

1. Press CONSOLE side tab .
2. Press **Demo GNSS**.
3. Press **Start**.
4. Press RETURN arrow  or CONSOLE side tab  to return to the main Console Settings screen.

NOTE: A console reboot is necessary in order to restore a real GNSS.

Figure 1-46: Demo GNSS



Restart Demo GNSS

Demonstration GNSS can be restarted.



1. Press CONSOLE side tab .
2. Press **Demo GNSS**.
3. Press **Restart**.
4. Press RETURN arrow  or CONSOLE side tab  to return to the main Console Settings screen.

Figure 1-47: Restart Demo GNSS



Feature Unlock

Feature Unlock is used to unlock advanced features.

NOTE: The unlock code is unique for each console. Contact TeeJet Technologies Customer Service. Once unlocked, a feature remains unlocked unless the console is fully reset.



1. Press CONSOLE side tab .
2. Press **Feature Unlock**.
3. Press the locked feature button  for the locked feature:
 - ▶ BoomPilot for Spreader – allows for spreader application options when used with a compatible spreader implement
 - ▶ FieldPilot Pro / UniPilot Pro – allows for AutoSteer options when using a SCM Pro
 - ▶ Third-Party Rate Control – allows for rate control options when used with a compatible third-party rate controller
4. Enter unlock code if required.
5. Restart the console.

Figure 1-48: Feature Unlocked



TOOLS

Tools is used to upload software updates for system devices, and to do various calculations on a regular calculator or a unit converter.

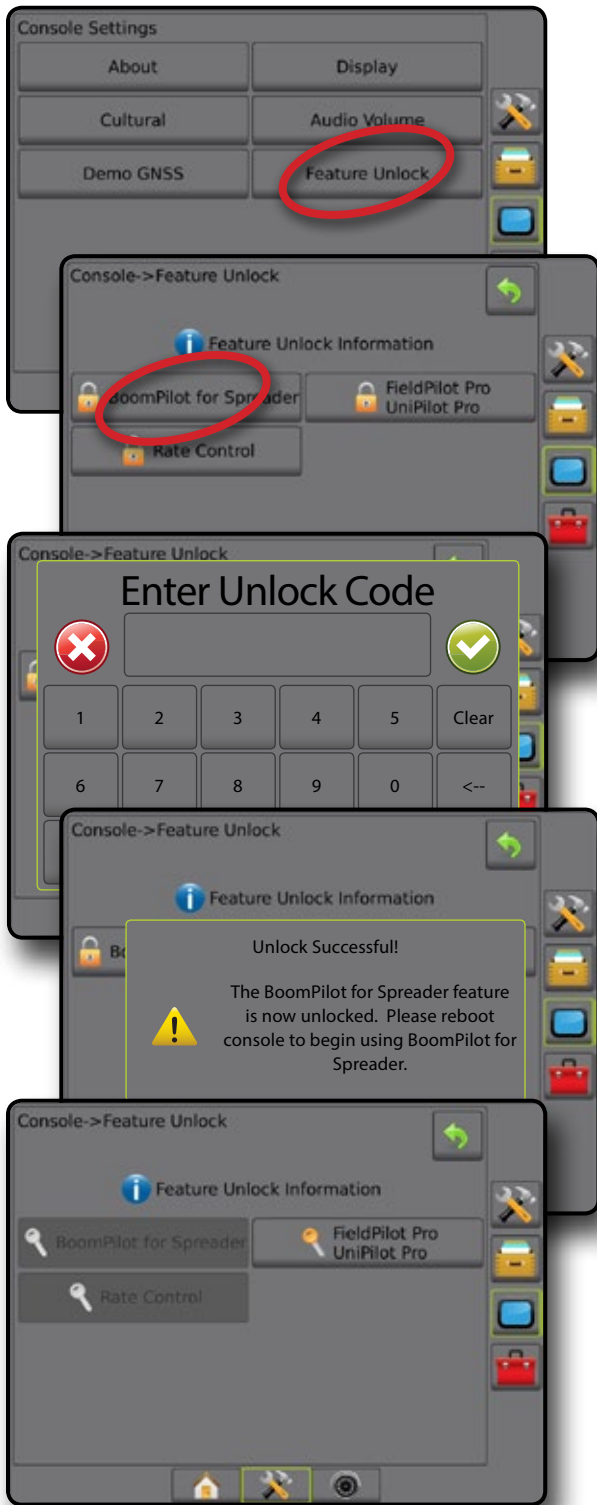

1. Press SYSTEM SETUP bottom tab .
2. Press TOOLS side tab .
3. Select from:
 - ▶ Upload Software – used to upload software updates from a USB drive for system devices.
 - ▶ Extras – accesses Calculator and Units Converter

Figure 1-49: Tools Options



Upload Software

The Upload Software screen is used to upload software updates from a USB drive for system devices.

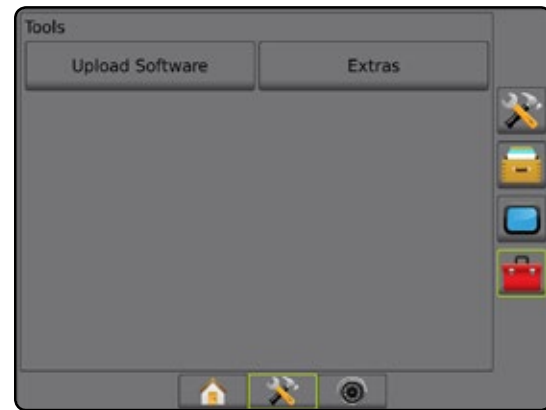
NOTE: Availability of this feature will vary depending on software version.





1. Press TOOLS side tab .
2. Press **Upload Software**.
3. Insert the USB drive containing software updates into the console.
4. Press Device DOWN arrow  and select the device for which software will be updated:
5. Press Software DOWN arrow  and select the software update to be uploaded to the device.
6. Press **Begin Upload**.
7. When prompted, press **OK**.
8. Press RETURN arrow  to return to the Tools screen, or press CONSOLE side tab  to return to the main Console Settings screen.

Figure 1-50: Upload Software



Figure 1-51: Calculator

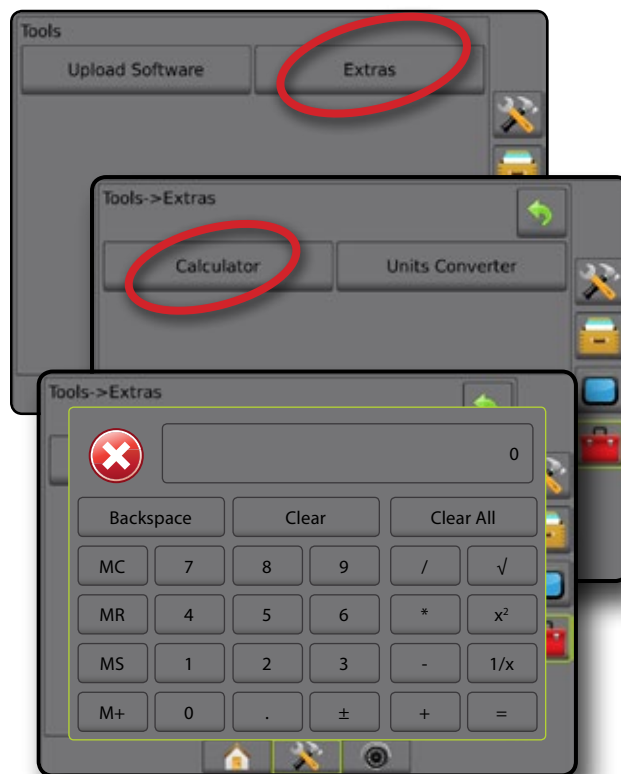
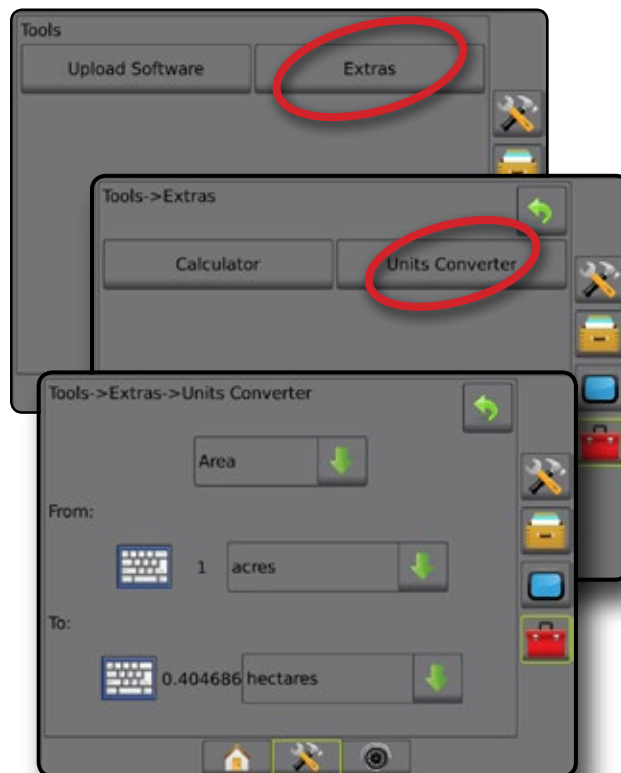



Figure 1-52: Units Converter



Extras

1. Press TOOLS side tab .
2. Press **Extras**.
3. Select from:
 - ▶ Calculator – used to perform mathematical calculations
 - ▶ Units Converter – used to perform unit conversions for area, length, volume, pressure, mass, temperature, or angle

CHAPTER 1 – GNSS RECEIVER CONFIGURATION

GNSS Receiver Configuration is used to configure GNSS Type, GNSS Port, and PRN, and other GNSS parameters, and to view GNSS status information.

GNSS Receiver Configuration

NOTE: These settings are required for rate control, assisted/ auto steering, and tilt sensor operation, as well as proper implement operation.





1. Press CONFIGURATION side tab .
2. Press **GNSS Receiver Configuration**.
3. Select from:
 - ▶ GNSS Type – sets to accept GNSS source transmissions: GPS, GLONASS, or SBAS (with or without DGPS Required).
 - ▶ GNSS Port – sets GNSS communication port: Internal or External
 - ▶ GNSS Status Information – displays current Baud Rate, Baud Rate Status, GNSS Status Information: GGA/VTG (Data Rates), Number of Satellites, HDOP, PRN, GGA Quality, Receiver, Receiver Version, UTM Zone, and correction model
 - ▶ Program – allows direct programming of the GNSS receiver through a command line interface. Only TeeJet support technicians should use this feature. Use at your own risk!
 - ▶ PRN – selects the first of two possible SBAS PRN's to provide SBAS correction data
 - ▶ Alternate PRN – allows possible selection of a second SBAS PRN to provide correction data
 - ▶ Show Refresh GNSS Position button – establishes if the refresh GNSS position button is available on the guidance screens
4. Press RETURN arrow  or CONFIGURATION side tab  to return to the main Configuration screen.

Figure 1-1: GNSS Options



GNSS Type

This menu allows the user to specify the requirements of the GGA data received by the application software based on the GGA Quality Indicator data field. These selections dictate the commands sent to program the internal receiver for use.

- GPS – uncorrected signals from the GPS system
 - GLONASS – uncorrected signals from the GLONASS system
 - SBAS (e.g. EGNOS, GAGAN, MSAS, SDCM, WAAS) – differentially corrected signals from the SBAS system
 - DGPS required – differentially corrected GPS signals
1. Press NEXT PAGE arrow  to access the list of options.
 2. Select:
 - ▶ GPS – single point uncorrected position data based on GPS only with a GGA QI of "1" is accepted.
NOTE: GPS is always selected.
 - ▶ GPS+GLONASS – single point uncorrected position data based on GPS and GLONASS with a GGA QI of "1" is accepted.
 - ▶ GPS+SBAS – either single point uncorrected or SBAS corrected position data are accepted - GGA QI of "1" or "2" (3, 4 or 5 are also accepted).

- ▶ GPS+GLONASS+SBAS – either single point uncorrected or SBAS corrected position data are accepted - GGA QI of "1" or "2" (3, 4 or 5 are also accepted).
- ▶ GPS+GLONASS+SBAS+DGPS – only GGA data with a QI value of "2" or higher is accepted (3, 4 or 5 are also accepted).

NOTE: All console based mapping, application and guidance functions are ceased if the GGA QI value drops below "2" with this setting checked.

3. Exit this screen to begin initializing the GNSS receiver. This takes about a minute, and the console will not respond until complete.

Figure 1-2: GNSS Type

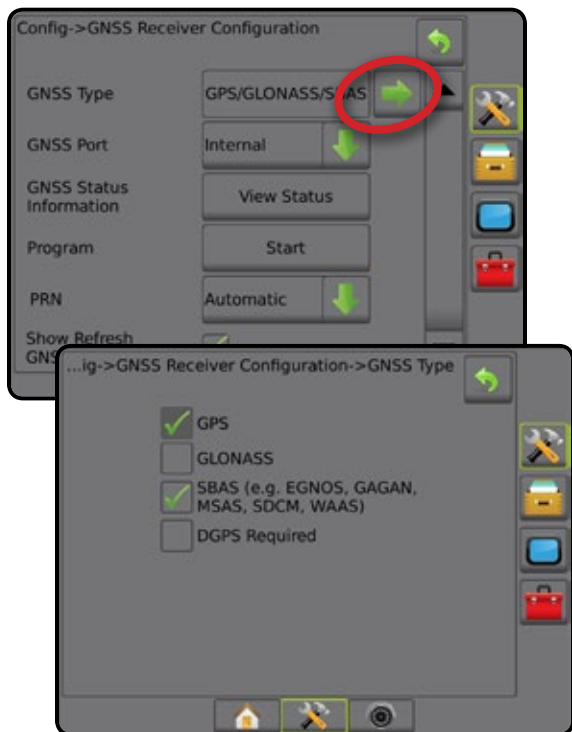

GNSS Port

The COM port can be set to "Internal" to use the internal GNSS receiver and transmit out, or "External" to receive external GNSS data.

1. Press DOWN arrow ↓ to access the list of options.
2. Select:
 - ▶ Internal – uses position data from the internal GNSS receiver; these NMEA data are sent out the RS-232 serial "Port A" of the Matrix harness at 115,200 baud
 - ▶ External – uses position data from an externally attached GNSS receiver attached to the RS-232 serial "Port A" of the Matrix harness

NOTE: An external receiver is required to work with TerraStar, OmniStar HP/XP, or RTK position data

Figure 1-3: GNSS Port



External Receiver Minimum Configuration Requirements
Before the Matrix Pro GS will connect and work with an external GNSS receiver, these minimum configuration requirements must be met.

Serial Port Settings	
Baud rate:	not allowed below 38,400
Recommended	38,400, 56,000, 57,600, 76,800, or 115,200
FieldPilot Pro / UniPilot Pro	115,200
Data Bits:	8
Parity:	None
Stop Bits:	1
Serial Port connection requirements	
Male 9-pin RS-232 serial cable	
<i>NOTE: May require Null modem adapter depending on pin-out of receiver.</i>	
NMEA Strings	
GGA	10.0 Hz
Optional VTG	10.0 Hz
ZDA	1.0 Hz

GNSS Status Information

GNSS Status Information displays a snapshot of the current GNSS status information.

1. Press **View Status**.
2. View data including:
 - ◀ Baud Rate – the current status of the GNSS
 - ◀ Baud Rate Status – the rate at which information is transferred/ communicated.

NOTE: a minimal baud rate maybe required for some software version to work at their peak performance.
 - ◀ GGA/VTG/TCP Data Rates – the number of GNSS positions per second.
 - ◀ Number of Satellites – the number of GNSS satellites in view (minimum of 4 are required for DGPS)
 - ◀ HDOP – a measure of satellite geometry strength in the horizontal plane. A HDOP value of less than 2 is preferred.
 - ◀ PRN – the current DGPS satellite ID
 - ◀ GGA Quality – the current quality indicator of the GNSS signal (see GGA Requirements chart)
 - ◀ Receiver – the current indicator of the receiver
 - ◀ Receiver Version – the software version installed on the receiver
 - ◀ UTM Zone – zone where currently located (see "UTM Coordinates and Zones" in this manual)
 - ◀ Model – the correction models available to be used with the current receiver configuration
3. Press **OK** to return to the GNSS Receiver Configuration screen.

NOTE: If GNSS is not available, all entries will be "Invalid".

Figure 1-4: GNSS Status Information

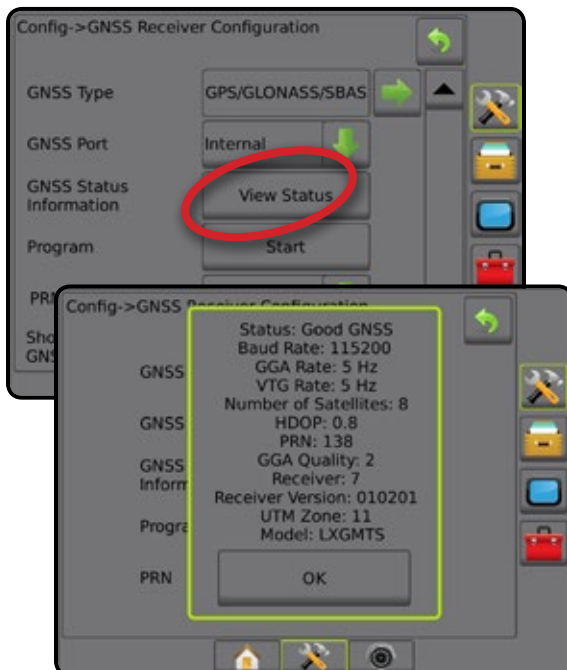

GNSS Status Information on Guidance Screens

GNSS Status displays information regarding current GNSS status, including data rates, number of satellites in view, HDOP and PRN status, receiver and version, satellite quality and ID, and UTM zone.

1. Press GNSS STATUS icon

Figure 1-5: Guidance Screen GNSS Status Information

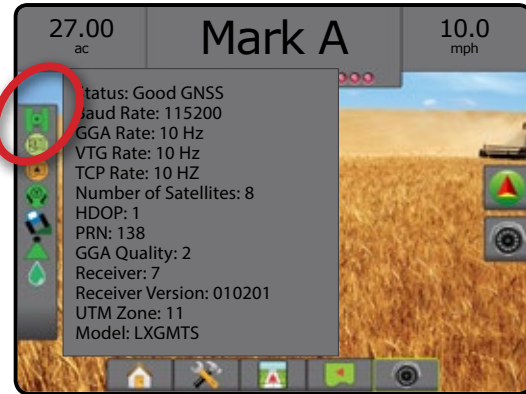

GGA Requirements

GGA Quality required to be able to work with various types of signal can vary. See table below for requirements.

Service	Indicator	Accuracy
GPS/GLONASS only	1	<10 m
WAAS/EGNOS	2	<1.5 m
RTK	4 or 5	4 cm
OmniSTAR HP/XP	5	10 cm
Glide/ClearPath*	9	<1 m
TerraStar C (converged)	5	10 cm

*For a 60 minute period.

Program

Program allows direct programming of the GNSS receiver through a command line interface. Only TeeJet support technicians should use this feature. Use at your own risk!

1. Press **Start**.
2. Adjust programming as required.

Figure 1-6: Programming Receiver



PRN

The PRN menu allows selection of up to two specific SBAS satellites to use for SBAS corrections. This allows the user to remove SBAS correction data from malfunctioning SBAS satellites.

1. Press DOWN arrow ↓ to access the list of options.
2. Select:
 - ▶ Automatic – automatic PRN selection
 - ▶ Number – contact your local dealer for the number associated with your operating location

Figure 1-7: PRN

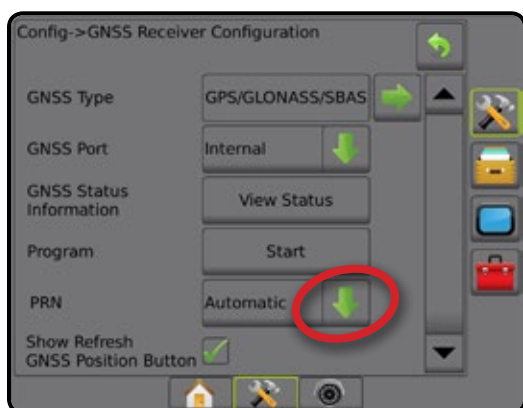

Alternate PRN

When PRN is not automatic, allows possible selection of a second SBAS PRN to provide correction data.

1. Press DOWN arrow ↓ to access the list of options.
2. Select:
 - ▶ None – no alternate PRN number
 - ▶ Number – contact your local dealer for the number associated with your operating location

Figure 1-8: Alternate PRN



PRN Not Shown

PRN options are only available with SBAS GNSS Type selected.

Figure 1-9: PRN Not Shown



Show Refresh GNSS Position Button

Show Refresh GNSS Position button establishes if the refresh GNSS position button is available on the guidance screens.

The refresh GNSS position button will reset the ClearPath filter in the OEMStar receiver in cases where the user has had the receiver running in close proximity to heavy tree cover and/or buildings.

NOTE: Activating the refresh while in a job will cause a momentary interruption in the relay of GNSS data. This will most likely result in sections already on in automatic BoomPilot mode to go off for a short period of time.

The refresh should not be done during active application.

Figure 1-10: Refresh GNSS Position Button

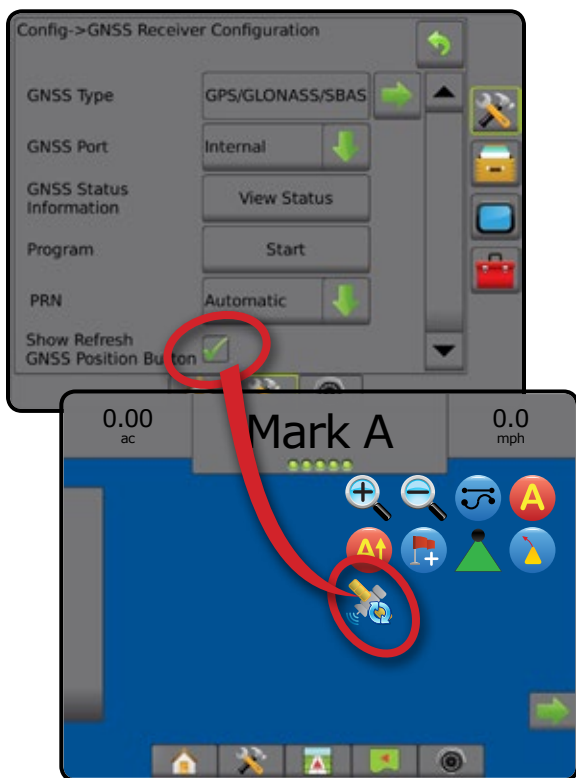

GNSS Glossary

Commercial Satellite Provider:

Another common source for DGPS signals. Error correction information obtained from their base stations is sent to a communications satellite (separate from the GPS satellites) and broadcast to the user. These satellite-based corrections tend to have more widespread coverage than tower-based broadcasts (FM links), and system accuracy is not greatly affected by the user's distance from the base station receivers. Most of these service providers require a subscription fee for use. A commonly known provider is OmniSTAR.

CORS (Continuously Operating Reference Station)/ Network RTK:

A series of base stations spread across a given geographic region (such as an entire state/county) that are networked via a centralized computer and which broadcast RTK correction data over the Internet. CORS networks may be publicly or privately owned/operated and may offer a free signal or require an annual subscription fee. By accessing a CORS network via a cellular connection, the end-user eliminates the need to own a base station.

Differential Corrections

Differential Corrections is a solution specific to the "double-differencing" algorithm used to determine the correction values applied by RTK to each GNSS satellites range data. "Corrections" is the generic term applied to all forms of potential corrections from SBAS (WAAS/EGNOS) through to OmniStar, TerraStar PPP and RTK.

Differential GPS (DGPS):

Use of the specific RTK solution to apply differential corrections to the GPS satellite constellation data.

EGNOS (European Geostationary Navigation Overlay Service):

A satellite based augmentation system (SBAS) developed jointly by the European space agency (ESA), European community and EUROCONTROL. The system is free to use and provides differential correction coverage primarily across the European continent. EGNOS delivers pass-to-pass accuracies of 15-25 cm and year-to-year accuracies of +/-1 m.

GLONASS (Global Navigation Satellite System):

A global satellite navigation system developed and operated by the Russian government. It is composed of approximately 24 satellites which continuously orbit the earth. While early GNSS receivers typically utilized only GPS signals, many of today's GNSS receivers can utilize signals from both GPS and GLONASS, effectively increasing the total number of satellites available for use.

GNSS Precise Point Positioning (PPP)

PPP is a subscription based globally provided satellite correction service broadcast to properly equipped GNSS receivers. PPP utilizes a global array of reference stations to correct for satellite clock and orbit errors which are then broadcast to local receivers. PPP does require a convergence time.

GNSS (Global Navigation Satellite System):

A general term that refers to a multiple satellite navigation system used by a receiver to compute its position. Examples of these systems include: GPS developed by the United States and GLONASS by Russia. Additional systems in development include Galileo by the European Union and Compass by China. New generation GNSS receivers are being designed to utilize multiple GNSS signals (such as GPS and GLONASS). Depending on constellation and desired accuracy levels, system performance may be improved by having access to a greater number of satellites.

GPS (Global Positioning System):

The name of the satellite-navigation network maintained by the U.S. Department of Defense. It is composed of approximately 30 satellites which continuously orbit the earth. The term is also used to refer to any device that depends on navigation satellites for functionality.

NTRIP (Networked Transportation of RTCM via Internet Protocol):

An internet-based application that makes the RTCM correction data from the CORS stations available to anyone with an internet connection and the appropriate log-on credentials to the NTRIP server. Typically uses a cellular link to get to the internet and the NTRIP server.

Positional Drift

The constant change in the GNSS position calculation primarily caused by atmospheric and ionospheric changes, poor satellite geometry (possibly caused by obstructions such as buildings and trees, satellite clock errors and satellite constellation changes. For sub-decimeter accuracy dual frequency receivers using either PPP or RTK solutions are recommended.

RTK (Real Time Kinematic):

Currently the most accurate GPS correction system available that uses a land-based reference station located in relatively close proximity to the GPS receiver. RTK can provide one-inch, also known as centimeter, pass-to-pass accuracy and also provides year-to-year position stability. RTK users can have their own base stations, subscribe to RTK Networks or use CORS.

SBAS (Satellite based augmentation system):

A general term that refers to any satellite-based differential correction system. Examples of SBAS include: WAAS in the United States, EGNOS in Europe and MSAS in Japan. Additional SBAS covering other regions of the world will likely be coming online in the future.

WAAS (Wide-area augmentation system):

A satellite correction service developed by the Federal Aviation Administration (FAA). It is free to use and provides coverage across the U.S. along with parts of Canada and Mexico. WAAS delivers pass-to-pass accuracies of 15-25 cm; however, year-to-year accuracy will be in the range of +/-1 m.

CHAPTER 1 – IMPLEMENT SETUP

Implement Setup is used to establish the various settings associated with straight mode, spreader mode, and staggered mode.

Settings will vary depending on if there is section control available: SmartCable, Section Driver Module (SDM), or Switch Function Module (SFM).

IMPLEMENT TYPE

Implement Type selects the type of application pattern that most closely represents your system.

- In Straight Mode – the boom sections have no length and are on a line a fixed distance from the antenna
- In Spreader Mode – a virtual line is created in line with the delivery disks from which the application section or sections can vary in length and can be at different distances from the line (availability depends on the specific equipment in the system)
- In Staggered Mode – a virtual line is created in line with Section 1 from which the application section or sections have no length and can be at different distances from the line (availability depends on the specific equipment in the system)

Section Numbers

Sections are numbered from left to right while facing in the machine's forward direction.

Figure 1-1: Implement Type – Straight

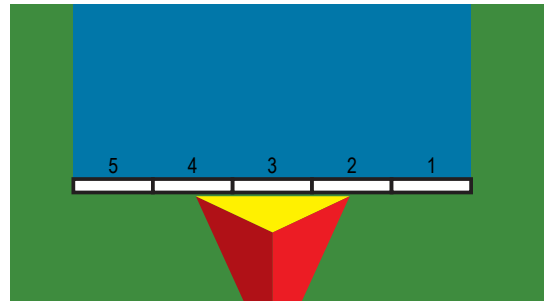

Figure 1-2: Implement Type – Spreader

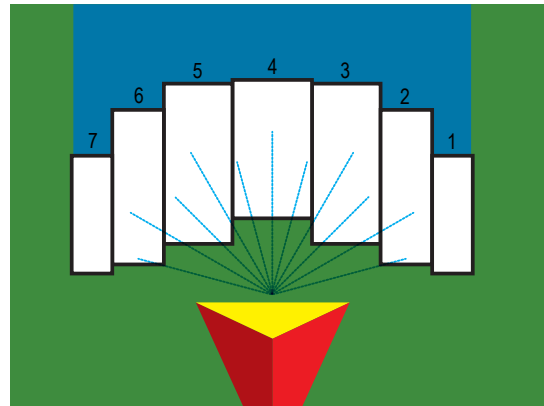
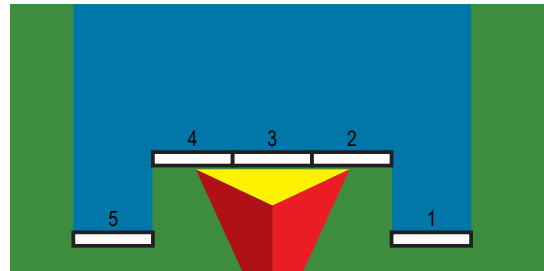

Figure 1-3: Implement Type – Staggered



Straight

The boom sections have no length and are on a line a fixed distance from the antenna.

Single Section

No section control is available on the system.

1. Select **Straight** implement type on Implement screen.
2. Press Implement Type NEXT PAGE arrow →.
3. Select from:
 - ▶ Implement In-line Offset Direction ① – establishes if the implement is located in front of (forward) or behind (backward) the GNSS antenna while facing in the vehicle's forward direction
 - ▶ Implement In-line Offset Distance ① – measured in parallel to the centerline of the vehicle, defines the in-line distance from the GNSS antenna to the implement in feet and tenths of feet
 - ▶ Implement Lateral Offset Direction ② – defines the lateral direction, either left or right, from the centerline of the machine to the center of the implement while facing in the machine's forward direction
 - ▶ Implement Lateral Offset Distance ② – defines the lateral distance from the centerline of the machine to the center of the implement in feet and tenths of feet
4. Press RETURN arrow ↶ to return to the Implement screen or CONFIGURATION side tab ⚙️ to return to the main Configuration screen.

Figure 1-4: Single Section

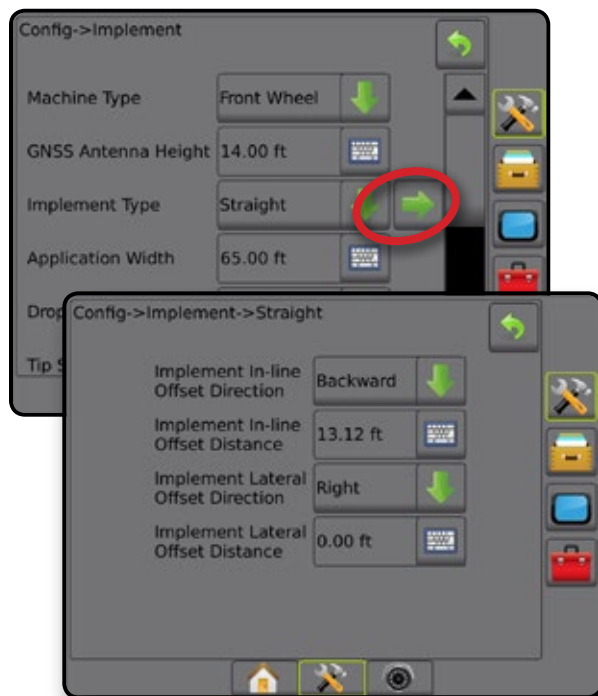
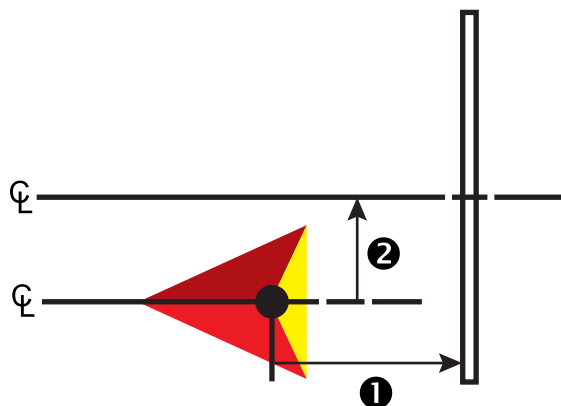

Figure 1-5: Offset Directions and Distances



Multiple Sections

Section control is available (SmartCable, Section Driver Module (SDM), or Switch Function Module (SFM)).

1. Select **Straight** implement type on Implement screen.
2. Press Implement Type NEXT PAGE arrow →.
3. Select from:
 - ▶ Implement In-line Offset Direction ① – establishes if the implement is located in front of (forward) or behind (backward) the GNSS antenna while facing in the vehicle's forward direction
 - ▶ Implement In-line Offset Distance ① – measured in parallel to the centerline of the vehicle, defines the in-line distance from the GNSS antenna to the implement in feet and tenths of feet
 - ▶ Implement Lateral Offset Direction ② – defines the lateral direction, either left or right, from the centerline of the machine to the center of the implement while facing in the machine's forward direction
 - ▶ Implement Lateral Offset Distance ② – defines the lateral distance from the centerline of the machine to the center of the implement in feet and tenths of feet.
 - ▶ Overlap – defines the amount of overlap allowed when using automatic boom section control
 - ▶ Delay On Time – used to set the time when the section will switch on when entering an area that has not been applied
NOTE: If the application turns on too soon when entering an unapplied area, decrease the Delay On time. If the application turns on too late, increase the Delay On time.
 - ▶ Delay Off Time – used to set the time when the section will switch off when entering an area that has been applied
NOTE: If the application turns off too soon when entering an unapplied area, decrease the Delay Off time. If the application turns off too late, increase the Delay Off time.
4. Press RETURN arrow ↶ to return to the Implement screen or CONFIGURATION side tab ⚙️ to return to the main Configuration screen.

Figure 1-6: Multiple Sections

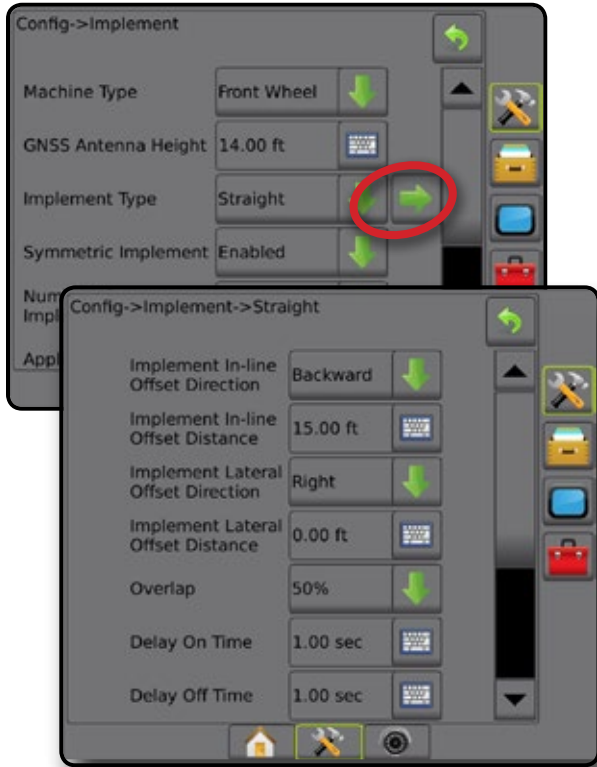

Figure 1-7: Offset Directions and Distances

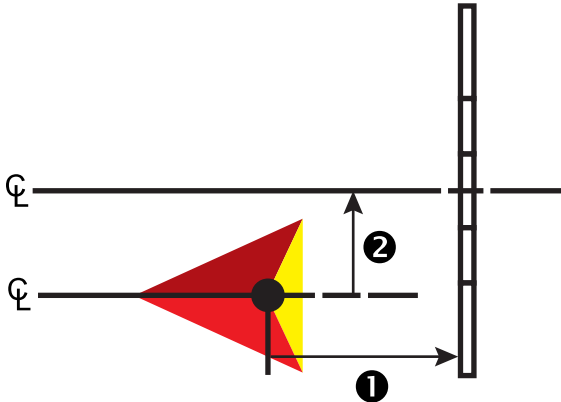
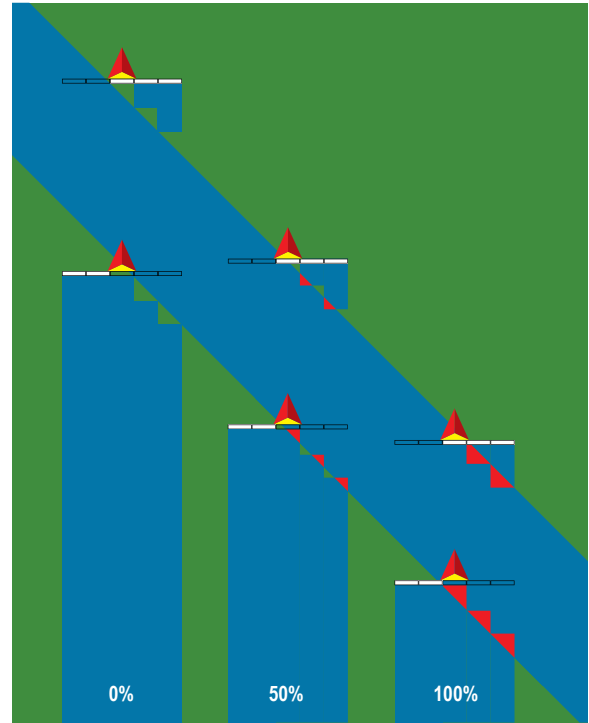

Figure 1-8: Overlap



Spreader – TeeJet

A virtual line is created in line with the delivery disks from which the application section or sections can vary in length and can be at different distances from the line (availability depends on the specific equipment in the system).

Single Section

No section control is available on the system.

1. Select **Spreader** implement type on Implement screen.
2. Press Implement Type NEXT PAGE arrow →.
3. Select from:
 - ▶ Setup Type – used to select **TeeJet** spreader type
 - ▶ Antenna to Disks Distance ① – defines the distance from the GNSS antenna to the disks or dispersal mechanism
 - ▶ Implement Lateral Offset Direction ② – defines the lateral direction, either left or right, from the centerline of the machine to the center of the implement while facing in the machine's forward direction
 - ▶ Implement Lateral Offset Distance ② – defines the lateral distance from the centerline of the machine to the center of the implement in feet and tenths of feet
 - ▶ Spread Offset Distance ③ – used to set the distance between the disks or dispersal mechanism and where product initially hits the ground for the section
 - ▶ Spread Length ④ – used to set the length of application for the section



4. Press RETURN arrow  to return to the Implement screen or CONFIGURATION side tab  to return to the main Configuration screen.

Figure 1-9: Single Section



Figure 1-10: Distances and Length

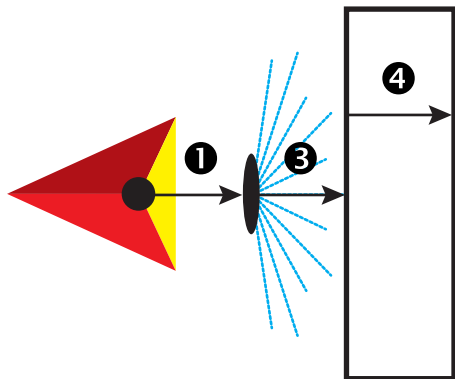
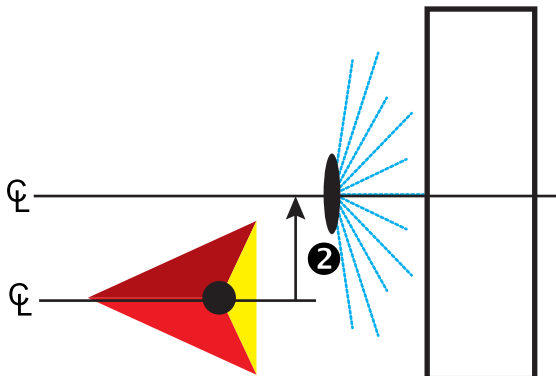



Figure 1-11: Lateral Offset Direction and Distance



Multiple Sections

Section control is available (SmartCable, Section Driver Module (SDM), or Switch Function Module (SFM)).

1. Select **Spreader** implement type on Implement screen.
2. Press Implement Type NEXT PAGE arrow .
3. Select from:
 - ▶ Setup Type – used to select **TeeJet** spreader type
 - ▶ Antenna to Disks Distance ① – used to define the distance from the GNSS antenna to the disks or dispersal mechanism
 - ▶ Implement Lateral Offset Direction ② – defines the lateral direction, either left or right, from the centerline of the machine to the center of the implement while facing in the machine's forward direction
 - ▶ Implement Lateral Offset Distance ② – defines the lateral distance from the centerline of the machine to the center of the implement in feet and tenths of feet
 - ▶ Overlap – used to define the amount of overlap allowed when using automatic boom section control
 - ▶ Delay On Time – used to set the time when the section will switch on when entering an area that has not been applied

NOTE: If the application turns on too soon when entering an unapplied area, decrease the Delay On time. If the application turns on too late, increase the Delay On time.
 - ▶ Delay Off Time – used to set the time when the section will switch off when entering an area that has been applied

NOTE: If the application turns off too soon when entering an unapplied area, decrease the Delay Off time. If the application turns off too late, increase the Delay Off time.
 - ▶ Spread Offset Distance ③ – used to set the distance between the disks or dispersal mechanism and where product initially hits the ground on Section 1.
 - ▶ Section Offsets ④ – used to set the offset distance from Section 1 (the Spread Offset line) to the leading edge of each section. Section 1 is always 0. All other sections can be different distances.
 - ▶ Section Lengths ⑤ – used to set the length of application in each section. Each section can be a different length.



NOTE: Sections are numbered from left to right while facing in the machine's forward direction.
4. Press RETURN arrow  to return to the Implement screen or CONFIGURATION side tab  to return to the main Configuration screen.

Figure 1-12: Multiple Sections



Figure 1-13: Distances and Length

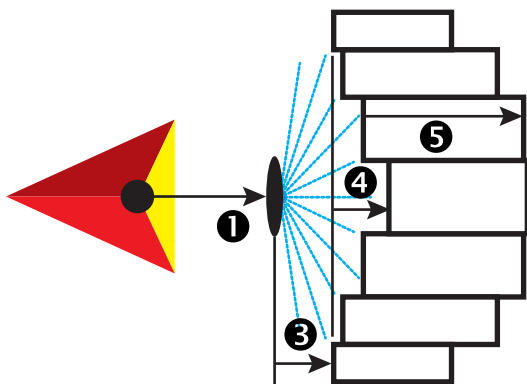

Figure 1-14: Lateral Offset Direction and Distance

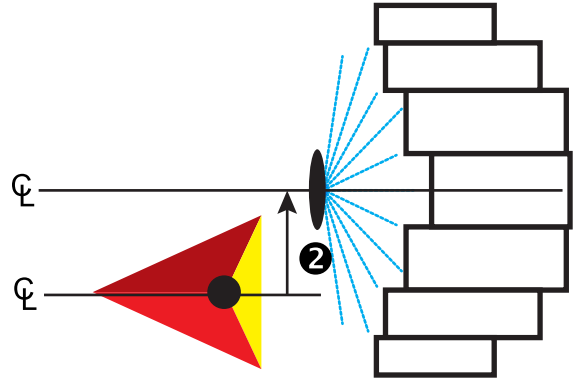
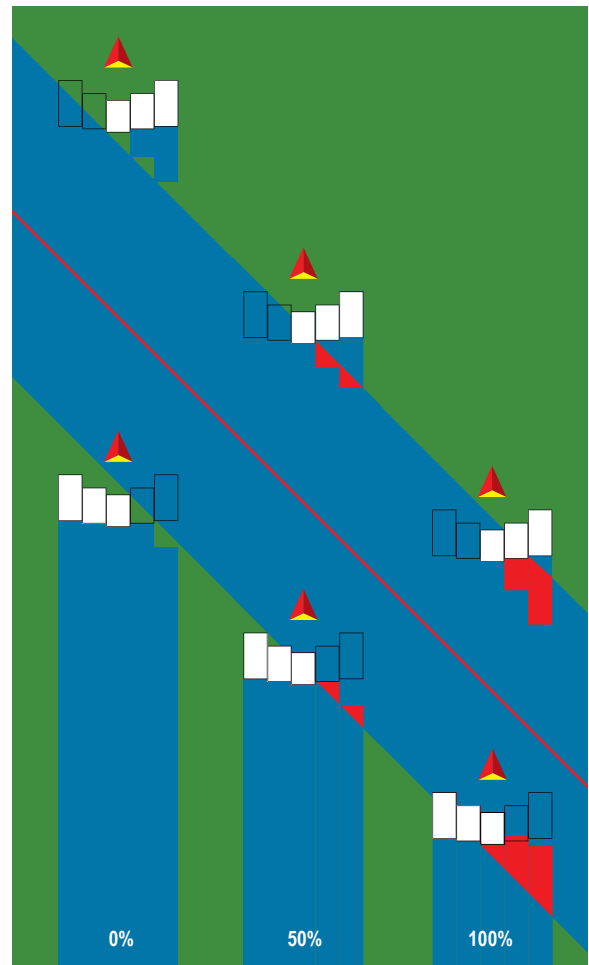

Figure 1-15: Overlap



Spreader – OEM

A virtual line is created in line with the delivery disks from which the application section or sections can vary in length and can be at different distances from the line.

Single Section

No section control is available on the system.

1. Select **Spreader** implement type on Implement screen.
2. Press Implement Type NEXT PAGE arrow .
3. Select from:
 - ▶ Setup Type – used to select **OEM** spreader type
 - ▶ Antenna to Disks Distance – used to define the distance from the GNSS antenna to the disks or dispersal mechanism
 - ▶ Implement Lateral Offset Direction – defines the lateral direction, either left or right, from the centerline of the machine to the center of the implement while facing in the machine's forward direction
 - ▶ Implement Lateral Offset Distance – defines the lateral distance from the centerline of the machine to the center of the implement in feet and tenths of feet
 - ▶ Start Distance – used to set the start distance when exiting an applied area (consult spreader manufacturer for value)
 - ▶ Stop Distance – used to set the stop distance when entering an applied area (consult spreader manufacturer for value)





NOTE: Consult spreader manufacturer for start and stop distances.
4. Press RETURN arrow  to return to the Implement screen or CONFIGURATION side tab  to return to the main Configuration screen.

Figure 1-16: Single Section

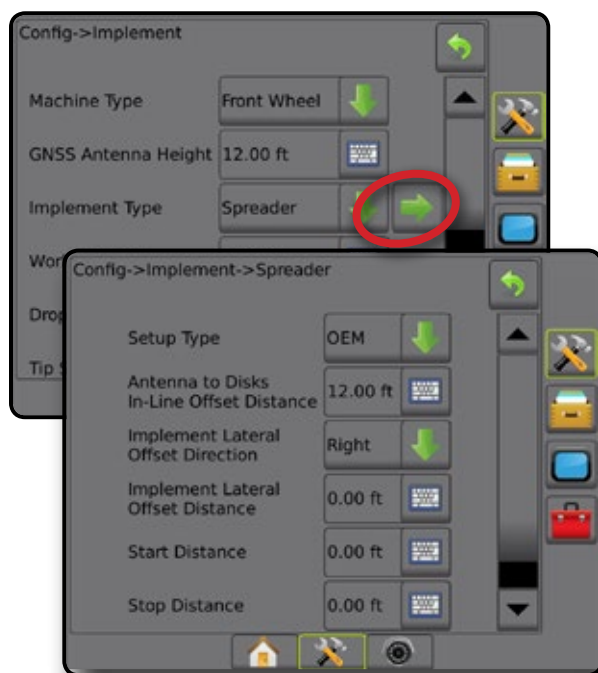

Multiple Sections

Section control is available (SmartCable, Section Driver Module (SDM), or Switch Function Module (SFM)).

1. Select **Spreader** implement type on Implement screen.
2. Press Implement Type NEXT PAGE arrow .
3. Select from:
 - ▶ Setup Type – used to select **OEM** spreader type
 - ▶ Antenna to Disks Distance – used to define the distance from the GNSS antenna to the disks or dispersal mechanism
 - ▶ Implement Lateral Offset Direction – defines the lateral direction, either left or right, from the centerline of the machine to the center of the implement while facing in the machine's forward direction
 - ▶ Implement Lateral Offset Distance – defines the lateral distance from the centerline of the machine to the center of the implement in feet and tenths of feet
 - ▶ Start Distance – used to set the start distance when exiting an applied area (consult spreader manufacturer for value)
 - ▶ Stop Distance – used to set the stop distance when entering an applied area (consult spreader manufacturer for value)

NOTE: Consult spreader manufacturer for start and stop distances.

 - ▶ Section Start Offsets – used to set the offset distance from Section 1 to the leading edge of each section. Section 1 is always 0. All other sections can be different distances.
 - ▶ Section Stop Offsets – used to set the offset distance from Section 1 to the trailing edge of each section. Each section can be a different distance.



NOTE: Consult spreader manufacturer for section start and stop offset values. Sections are numbered from left to right while facing in the machine's forward direction.
4. Press RETURN arrow  to return to the Implement screen or CONFIGURATION side tab  to return to the main Configuration screen.

Figure 1-17: Multiple Sections



Staggered

A virtual line is created in line with Section 1 from which the application section or sections have no length and can be at different distances from the line.

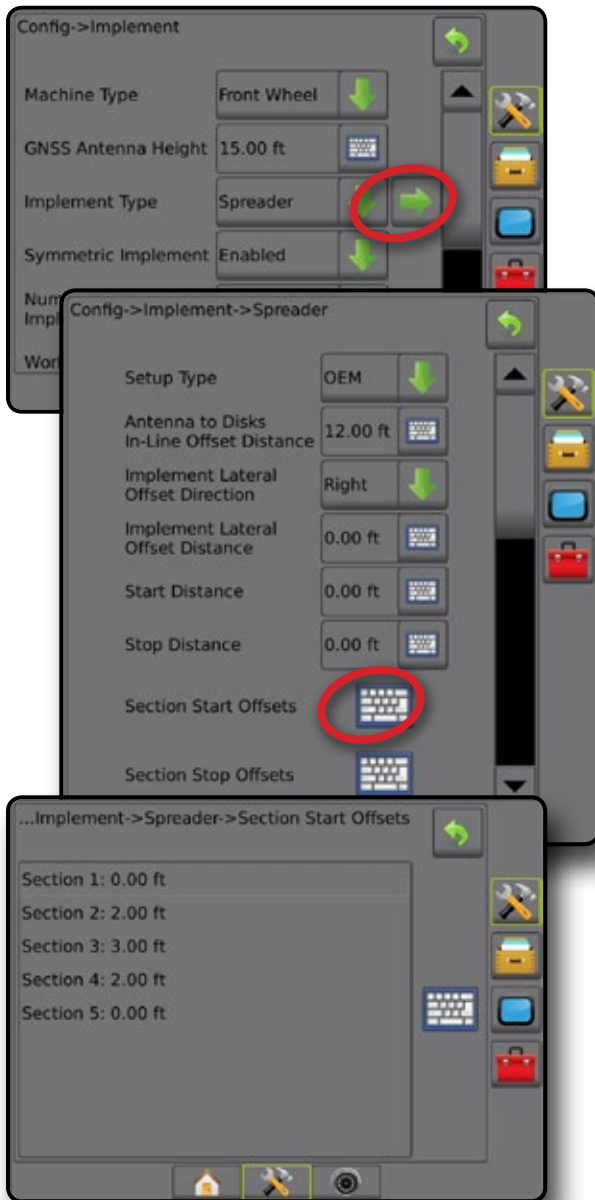
Multiple Sections

Section control is available (SmartCable, Section Driver Module (SDM), or Switch Function Module (SFM)).



1. Select **Staggered** implement type on Implement screen.
2. Press Implement Type NEXT PAGE arrow .
3. Select from:
 - ▶ In-line Section 1 Offset Direction ❶ – used to select whether Section 1 (the zero-point of the Section Offsets) is located in front of or behind the GNSS antenna as the vehicle moves in a forward direction
 - ▶ In-line Section 1 Offset Distance ❶ – used to define the in-line distance from the GNSS antenna to Section 1 (the zero-point of the Section Offsets)
 - ▶ Implement Lateral Offset Direction ❷ – defines the lateral direction, either left or right, from the centerline of the machine to the center of the implement while facing in the machine's forward direction
 - ▶ Implement Lateral Offset Distance ❷ – defines the lateral distance from the centerline of the machine to the center of the implement in feet and tenths of feet
 - ▶ Overlap – used to define the amount of overlap allowed when using automatic boom section control
 - ▶ Delay On Time – used to set the time when the section will switch on when entering an area that has not been applied
NOTE: If the application turns on too soon when entering an unapplied area, decrease the Delay On time. If the application turns on too late, increase the Delay On time.
 - ▶ Delay Off Time – used to set the time when the section will switch off when entering an area that has been applied
NOTE: If the application turns off too soon when entering an unapplied area, decrease the Delay Off time. If the application turns off too late, increase the Delay Off time.
 - ▶ Section Offsets ❸ – used to set the offset distance from Section 1 (the In-Line Section 1 Offset Distance line) to each section. A positive offset value will move the section behind Section 1. A negative offset value will move the section in front of Section 1. Section 1 is always 0. All other sections can be different distances.
4. Press RETURN arrow  to return to the Implement screen or CONFIGURATION side tab  to return to the main Configuration screen.

Figure 1-18: Multiple Sections

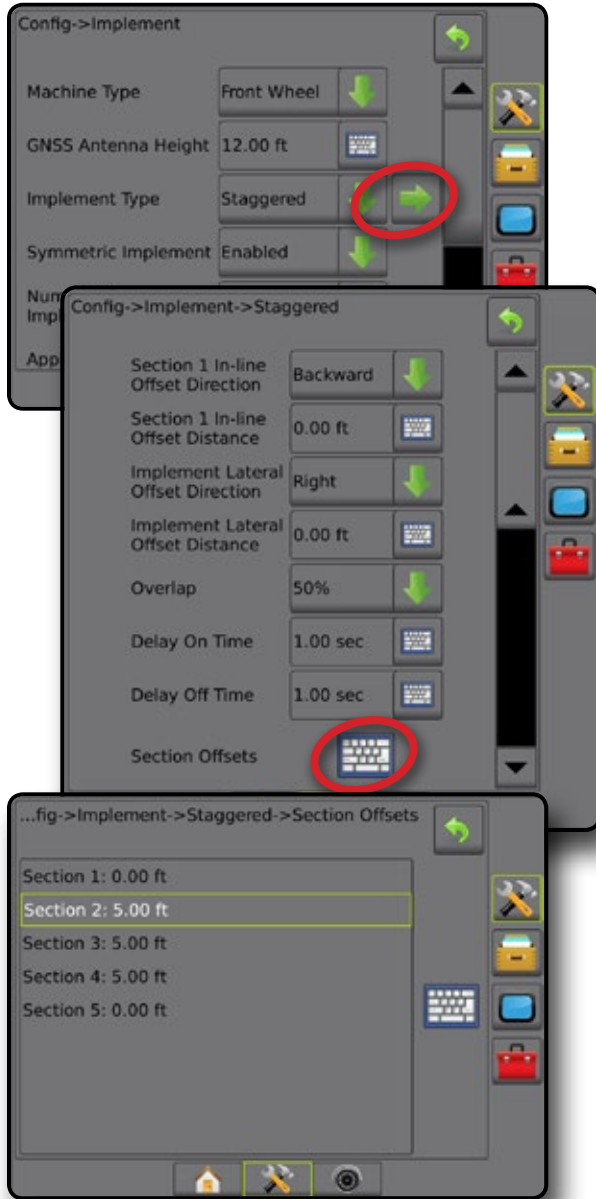

Figure 1-19: Offset Directions and Distances – behind section 1

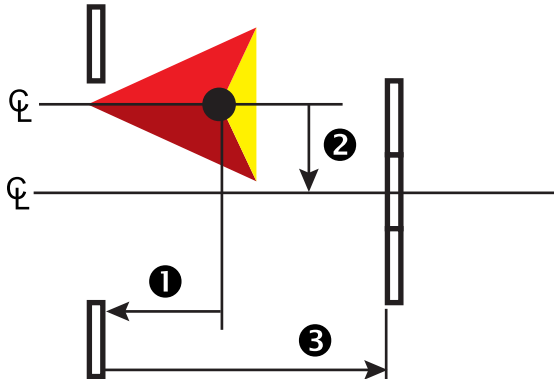

Figure 1-20: Offset Directions and Distances – in front of section 1

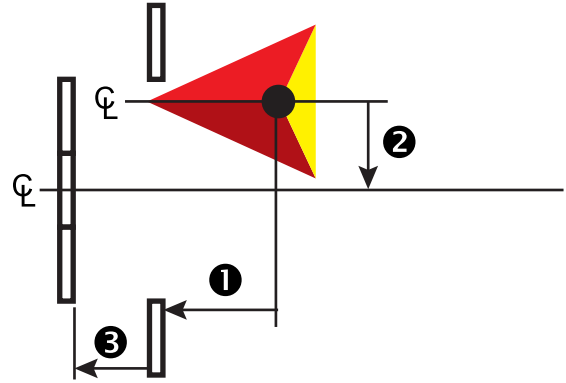
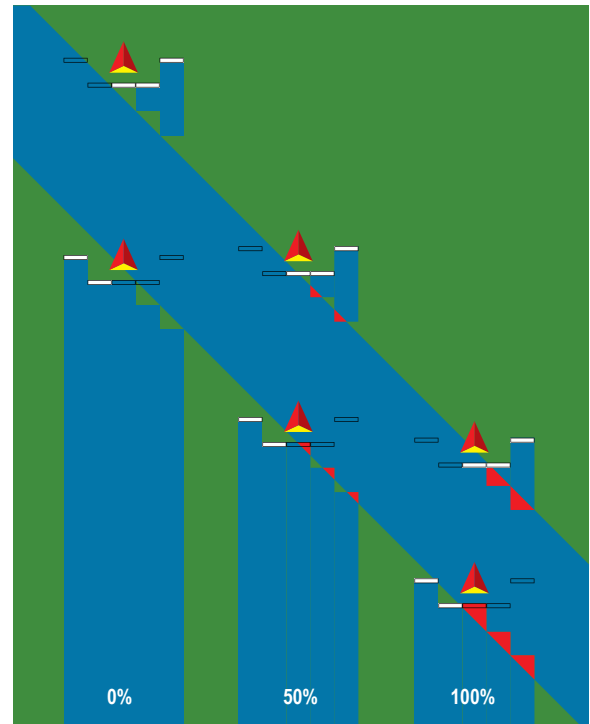

Figure 1-21: Overlap



APPLICATION OR WORKING WIDTH

Application Width [Straight Implement Type or Staggered Implement Type] or Working Width [Spreader Implement Type] is used to enter the width of the single section or width of each section to calculate the total width of the implement.

Single Section

No section control is available on the system.

Application Width or Working Width is used to enter the total width of the single section of the implement. Range is 3.28 to 246.06 feet / 1.0 to 75.0 meters.





1. Press CONFIGURATION side tab .
2. Press **Implement**.
3. Press the Application Width [Straight Implement Type] or Working Width [Spreader Implement Type] KEYPAD icon .
4. Use the numeric keypad to enter a value.
5. Press RETURN arrow  or CONFIGURATION side tab  to return to the main Configuration screen.





Figure 1-22: Single Section – Application or Working Width

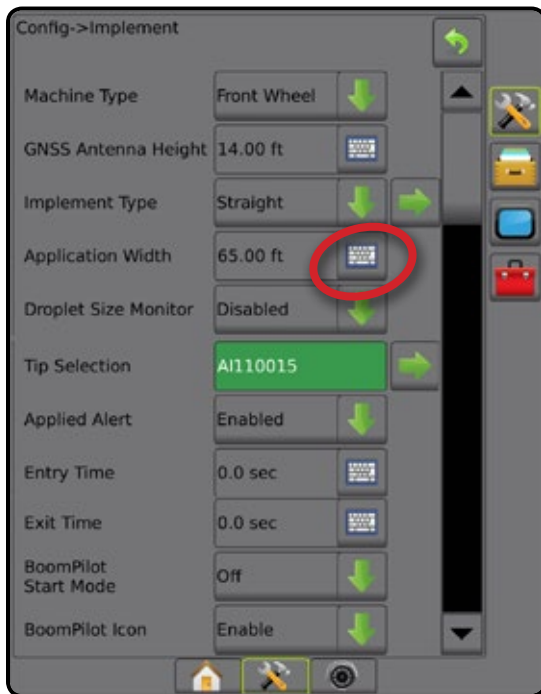

Multiple Sections

Section control is available when any of the following are on the system: SmartCable, Section driver module (SDM), Switch function module (SFM).

Application Width or Working Width is used to enter the width of each section to calculate the total width of all sections of the implement. Each section can be a different width. Sections are numbered from left to right while facing in the machine's forward direction. Range for each section is 0.0 to 246.06 feet / 0.0 to 75.0 meters. Total for all sections must be greater than 3.28 feet / 1.0 meter.

1. Press CONFIGURATION side tab .
2. Press **Implement**.
3. Press the Application Width [Straight Implement Type or Staggered Implement Type] or Working Width [Spreader Implement Type] KEYPAD icon .
4. Highlight the section to be entered or edited.
5. Press the KEYPAD icon .
6. Use the numeric keypad to enter the width of the selected section.
7. Press RETURN arrow  or CONFIGURATION side tab  to return to the Implement screen or main Configuration screen.

NOTE: If Symmetric Implement Layout is enabled, only the first of each pair of aligned sections will be available to be highlighted.

Figure 1-23: Multiple Sections – Application or Working Width

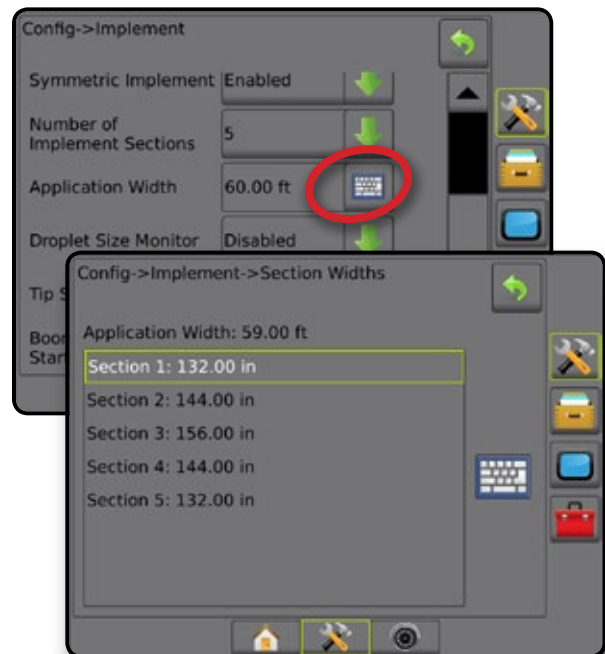

IMPLEMENT LATERAL OFFSET DISTANCE ADJUSTMENT

Implement lateral offset distance is used to enter the distance from the centerline of the machine to the center of the implement. When on-screen mapping shows no overlap or gap, yet field application produces an overlap or gap consistently to only one side in the direction of travel, an adjustment to the implement lateral offset distance should be calculated and made to the implement offset distance value.

If using a self-propelled sprayer or spreader, use the GNSS Offset Adjustment Calculation to calculate the implement offset distance adjustment.

If using a pull behind or trailed implement, use the Implement Offset Adjustment Calculation to calculate the implement offset distance adjustment.

NOTE: While using assisted/auto steering, if on-screen mapping shows overlaps and gaps, adjustments may need to be made to the assisted/auto steering settings.

Figure 1-24: Implement Lateral Offset Distance

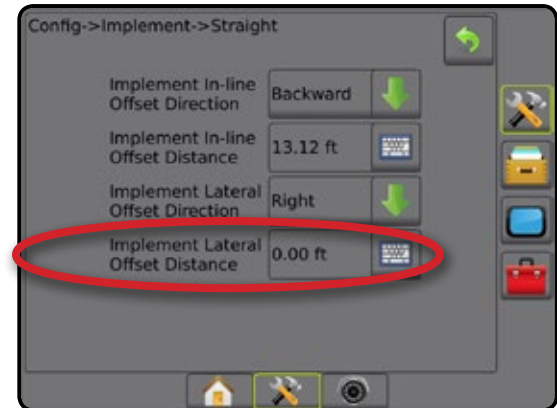

GNSS Offset Adjustment Calculation

To calculate a GNSS offset adjustment using the same guideline:

1. Create a straight AB line.
2. With assisted/auto steering engaged, drive pass ① at least 100 feet / 30 meters, and place flags at the draw bar or next to the machine.
3. Turn around and engage assisted/auto steering on pass ② on the same AB guideline. Place flags at the draw bar or next to the machine, or stop while on the AB guideline next to the flags you placed on pass ①.
4. Measure the difference ③ between the flags of pass ① and pass ②.
5. Divide the measured distance ③ in half. This difference will be the offset adjustment.
6. Increase or decrease the offset distance as needed dependent on where the field application overlap occurs and the current implement offset direction setting.

Field Application Overlap	Current Offset Settings		
	Offset Direction = Left	Offset Direction = Right	Offset Direction = Right Offset Distance = 0 ft/m
To the right of pass ①	Increase distance offset value	Decrease distance offset value	Increase distance offset value
To the left of pass ①	Decrease distance offset value	Increase distance offset value	Change to implement offset direction to left and increase distance offset value

Figure 1-25: GNSS Offset Distance

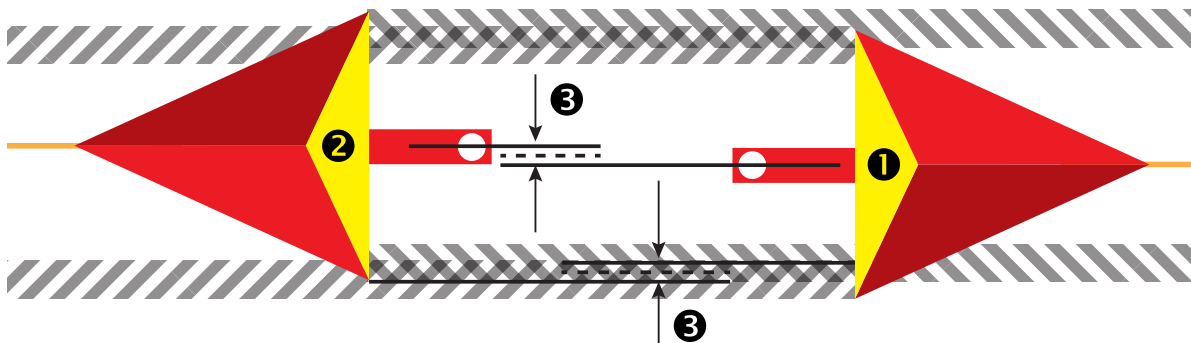

Implement Lateral Offset Adjustment

To calculate an implement offset adjustment using adjacent guidelines:

1. Create a straight AB line.
2. With assisted/auto steering engaged, drive pass ① as if you were operating the implement, and place flags at the outside edges of the implement.
3. Turn around and engage assisted/auto steering on pass ② on the adjacent AB guideline. Place additional flags at the outside edges of the implement or stop while on the AB guideline next to the flags you placed on pass ①.
4. Measure the difference ③ between the flags of pass ① and pass ②.
5. Divide the measured distance ③ in half. This difference will be the offset adjustment.
6. Increase or decrease the offset distance ④ as needed dependent on where the field application overlap occurs and the current implement offset direction setting.

Field Application	Current Offset Settings		
	Offset Direction = Left	Offset Direction = Right	Offset Direction = Right Offset Distance = 0 m
Overlap on the right of pass ① or Gap on the left of pass ①	Increase distance offset value	Decrease distance offset value	Increase distance offset value
Overlap on the left of pass ① or Gap on the right of pass ①	Decrease distance offset value	Increase distance offset value	Change to implement offset direction to left and increase distance offset value

Figure 1-26: Implement Lateral Offset Distance and Direction

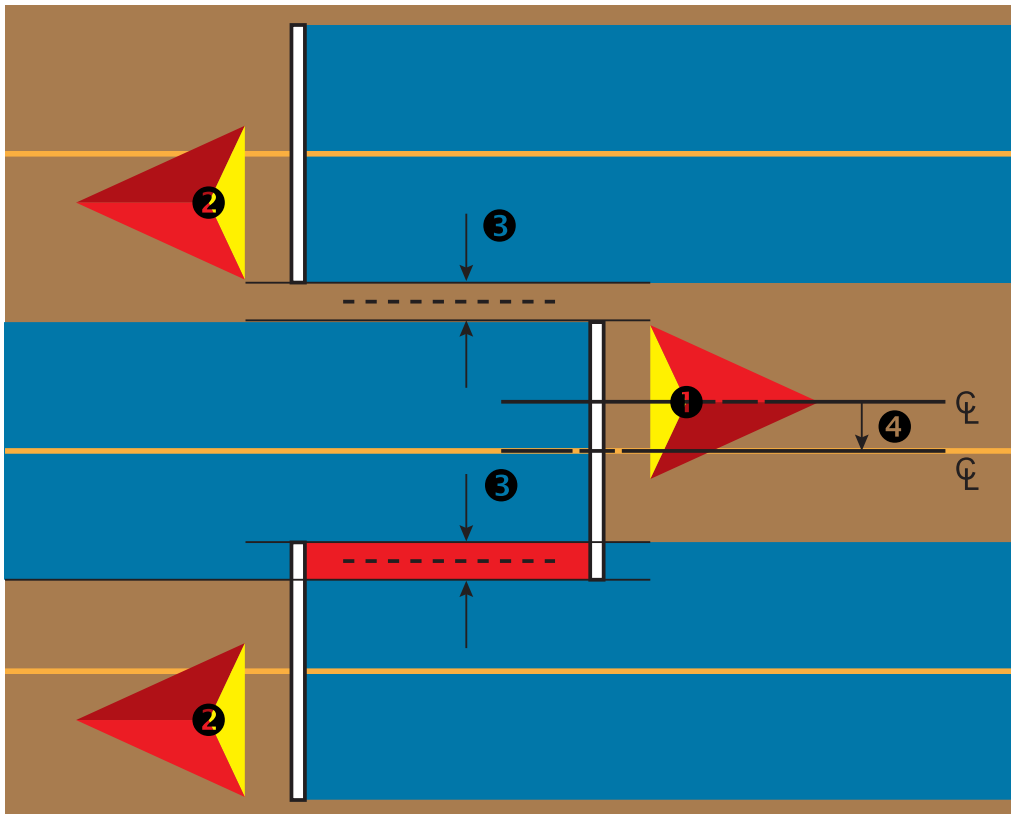

REVERSE SENSE

Reverse sense options are used when adding a Reverse sense module, SCM (Steering Control Module for FieldPilot IV) or SCM Pro (Steering Control Module Pro for FieldPilot Pro/UniPilot Pro) to any configuration. This allows for application mapping and control, and on-screen guidance when traveling in reverse.

1. Press CONFIGURATION side tab .
2. Press **Implement**.
3. In addition to standard options, select from:
 - ▶ Allow BoomPilot in Reverse – used to enable BoomPilot function while traveling in reverse
 - ▶ Reverse Signal Delay – used to set the delay when going from forward to reverse or reverse to forward, after which the vehicle icon on a navigation screen changes direction

Figure 1-27: Reverse Sense Module



Reverse on Guidance Screens

While traveling in reverse, having BoomPilot in reverse active allows for product application, automatic section control, and mapping that is correct for reverse machine movement.

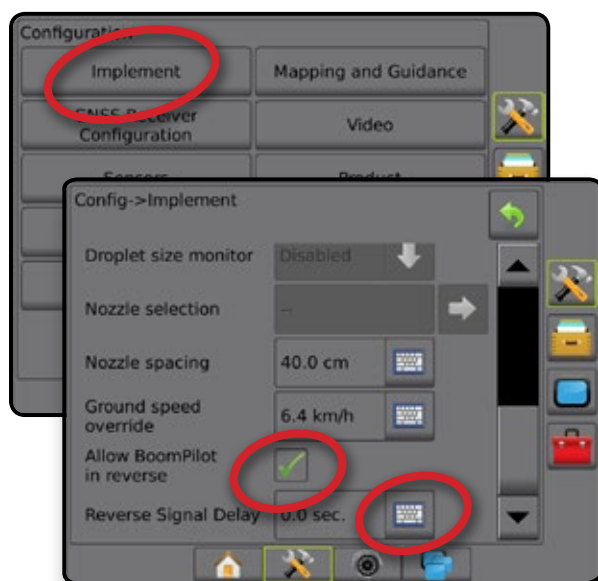
- ◀ Speed on the Guidance bar will turn red while traveling in reverse

Figure 1-28: Traveling Forward

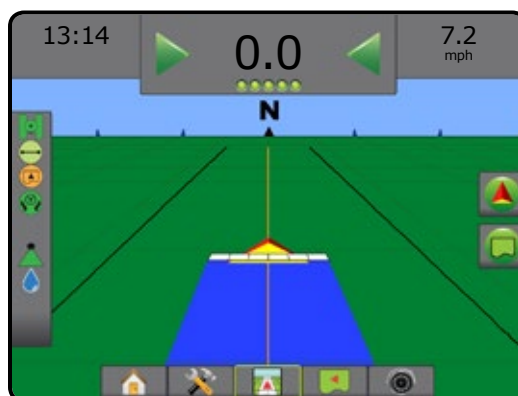
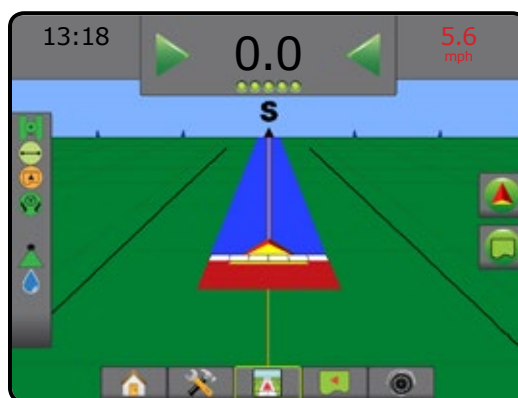

Figure 1-29: Traveling in Reverse



Availability with different system configurations

Automatic Section Control device on system	Device sensing reverse vehicle movement	BoomPilot in reverse feature available	BoomPilot in reverse can be turned on/off in menu using Allow BoomPilot in Reverse	Signal delay can be adjusted using Reverse Signal Delay
SDM or SFM	FieldPilot IV *	✓	✓	✓
	Reverse Sense Module	✓	✓	✓
	FieldPilot Pro / UniPilot Pro	✓	✓	x**

* Optional function that is hardware dependent.

** Controlled directly by the FieldPilot Pro / UniPilot Pro.

TIP SELECTION

When the system includes a Pressure Sensor Interface Kit (PSIK), Tip Selection is used to select the type of sprayer tip (series and capacity) for determining droplet size information.





1. Press CONFIGURATION side tab .
2. Press **Implement**.
 - ▶ Current Tip selection is shown in the information box
3. Press Tip Selection NEXT PAGE arrow .
4. Select from:
 - ▶ Tip Preset 1-5 – selects up to five (5) tips for quick recall, and selected the current tip for determining droplet size information
 - ▶ Current Tip – displays the current tip
5. Press RETURN arrow  or CONFIGURATION side tab  to return to the main Configuration screen.

Figure 1-30: Droplet Size Monitor



Preset

Tip presets allow saving of up to five tips for quick recall.

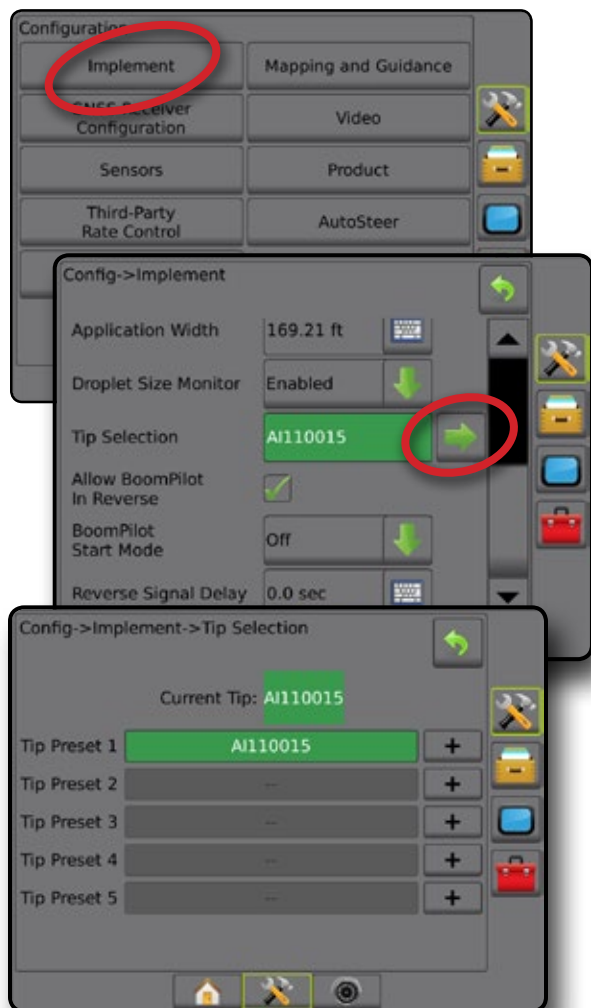
1. Press **+**.
2. Select a TeeJet tip series.
3. Select tip capacity.

Figure 1-31: Preset Tip

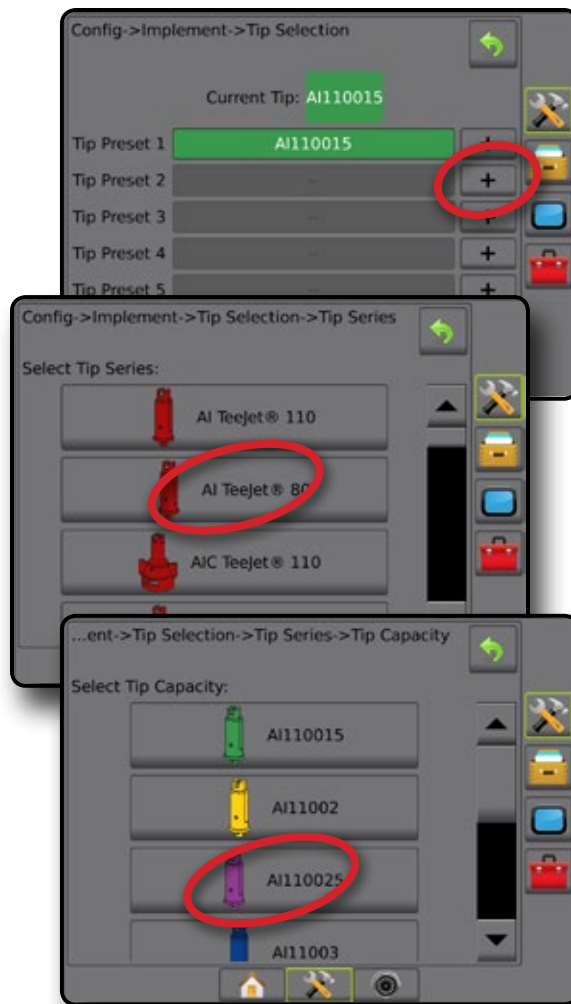

Figure 1-32: Tip sizes and associated colors

Established Tip Capacities and Colors			
Size	Color	Size	Color
01	Orange	06	Gray
015	Green	08	White
02	Yellow	10	Light Blue
025	Purple	12	Telemagenta
03	Blue	15	Light Green
04	Red	20	Black
05	Brown	30	Beige

Current Tip

Current Tip shows the active tip for determining current droplet size information. Tips must be preset to be available for current tip selection.

1. Press desired tip.

Selected tip will be shown:

- ◀ The information box on the Implement screen
- ◀ The Droplet/Pressure Status display from the status bar on the guidance screens

Figure 1-33: Current Tip

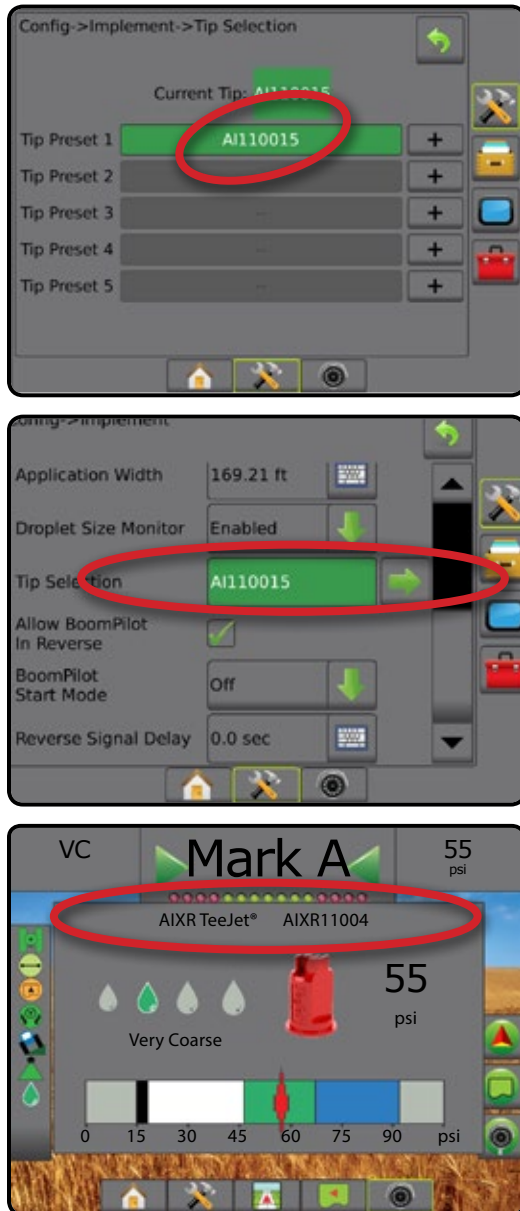

DROPLET SIZE MONITOR

When the system includes a Pressure Sensor Interface Kit (PSIK), Droplet Size Monitor can be enabled/disabled. The DSM then becomes available on the operation screens.

Setup

Enable/Disable DSM

1. Press CONFIGURATION side tab
2. Press **Implement**.
3. Press **Droplet Size Monitor**.
4. Select if droplet size monitor is enabled or disabled.
5. Press RETURN arrow or CONFIGURATION side tab to return to the main Configuration screen.

NOTE: When Droplet Size Monitor is disabled, the Droplet/Pressure Status is not available on the guidance screen status bar.

Figure 1-34: Droplet Size Monitor

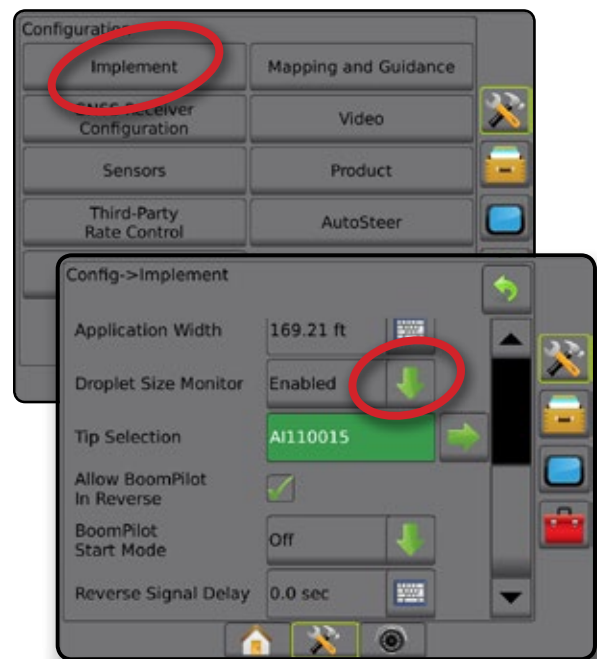

Tip Selection / Current Tip

To establish the tip presets and current tip, see "Tip Selection" in this chapter.

Input/Output Module Pressure Sensor

When a Pressure Sensor Interface Kit is present, Pressure Sensor options are used to enter the sensor manufacturer's maximum pressure rating and set high and low user determined pressure alarms.

NOTE: For more information, see "Sensors" in the Setup chapter of this manual.

Operation

Status Bar

Droplet/Pressure Status displays information regarding the current status of the droplet size and system pressure.





1. Press DROPLET/PRESSURE STATUS icon .
2. Press the screen anywhere to return to the guidance screen.

Figure 1-35: Droplet/Pressure Status

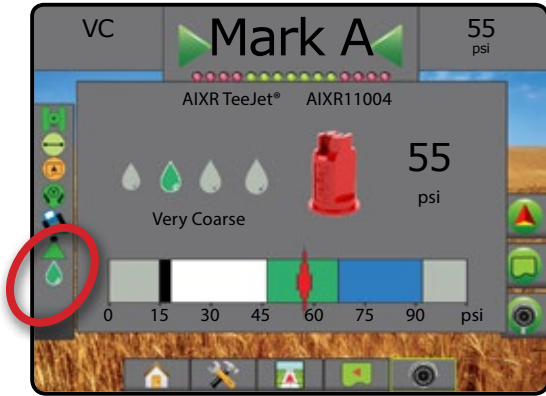

Droplet/Pressure Status

	Colored = Engaged. The color of the droplet is directly associated with the current droplet size. Color options include: 
	Crossed Out = Disabled
	No icon = no Pressure Sensor Interface Kit is installed on system

Droplet Size Chart

When choosing a spray tip that produces droplet sizes in one of the eight droplet size classification categories, always remember that a single tip can produce different droplet size classifications at different pressures. A tip might produce medium droplets at low pressures, while producing fine droplets as pressure is increased.

Category	Symbol	Color Code
Extremely Fine	XF	Violet
Very Fine	VF	Red
Fine	F	Orange
Medium	M	Yellow
Coarse	C	Blue
Very Coarse	VC	Green
Extremely Coarse	XC	White
Ultra Coarse	UC	Black

Guidance Bar

The Guidance bar keeps you informed of your choice of selectable information including Current System Pressure and Current Droplet Size.

1. Press SELECTABLE INFORMATION box.
2. Select from:
 - ▶ System Pressure – displays the current system pressure
 - ▶ Droplet Size – displays the current tip droplet size
3. Press outside the selection box to return to the guidance screen.

Figure 1-36: Guidance Bar Selectable Information



BOOMPILOT SECTION CONTROL

Depending on if there is a section control system present and, when present, what kind of section control is being used as well as what options are enabled, there are multiple options for BoomPilot section control. The settings of BoomPilot Start Mode and BoomPilot Icon change how section control is handled on the guidance screens.



1. Press CONFIGURATION side tab .
2. Press **Implement**.
3. Select from:
 - ▶ BoomPilot start mode – used to establish if automatic BoomPilot activation is controlled automatically by speed or manually using the BoomPilot icon in the navigation and guidance options on the guidance screens
 - ◀ Automatic – automatic section control will be controlled by speed
 - ◀ Off – automatic section control is disabled and can be manually controlled by the BoomPilot icon in the navigation and guidance options on the guidance screens
 - ▶ BoomPilot icon – used to establish if the BoomPilot icon is available in the navigation and guidance options on the guidance screens for manually controlling BoomPilot
 - ◀ Enable – BoomPilot icon will be available in the navigation and guidance options on the guidance screens to control automatic section control
 - ◀ Disable – BoomPilot icon will not be available in the navigation and guidance options
4. Press RETURN arrow  or CONFIGURATION side tab  to return to the main Configuration screen.

Figure 1-37: BoomPilot Options

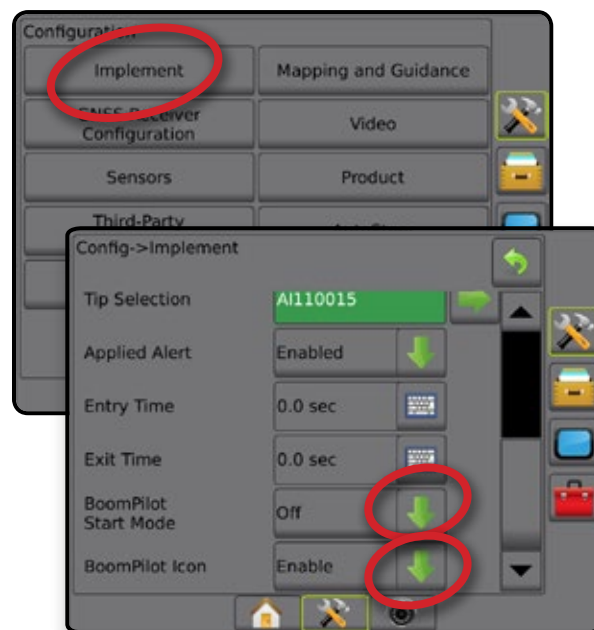
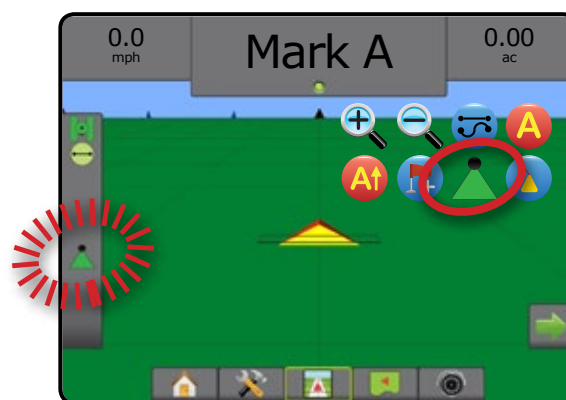















Figure 1-38: BoomPilot Icon on Guidance Screen



Availability with different hardware systems

Hardware on System	Available on Configuration-> Implement menu and works when on guidance screens	
	BoomPilot Start Mode	BoomPilot Icon
SDM/SFM Only (no TeeJet ASB SwitchBox)	Yes	Yes
SDM + TeeJet ASB Switchbox	No	No
SFM + ISM	Yes	Yes

CHAPTER 1 – GUIDANCE AND MAPPING

The Matrix Pro GS allows product application and vehicle guidance to be performed simultaneously. Once system setup is complete, guidance can begin. Six guidance modes allow users to optimize the field work: Straight AB , Curved AB , Circle Pivot , Last Pass , NextRow  and Adaptive Curve . Additional optimization can be accomplished with Interior Boundary , Exterior Boundary  and/or Polygon  application; Curved Lookahead ; Return to Point ; and RealView Guidance over video . In addition, Coverage  and Application mapping functions can display and record product application, and Prescription and Target rate maps can direct product application.

Overview

Three guidance screens assist in keeping you informed.







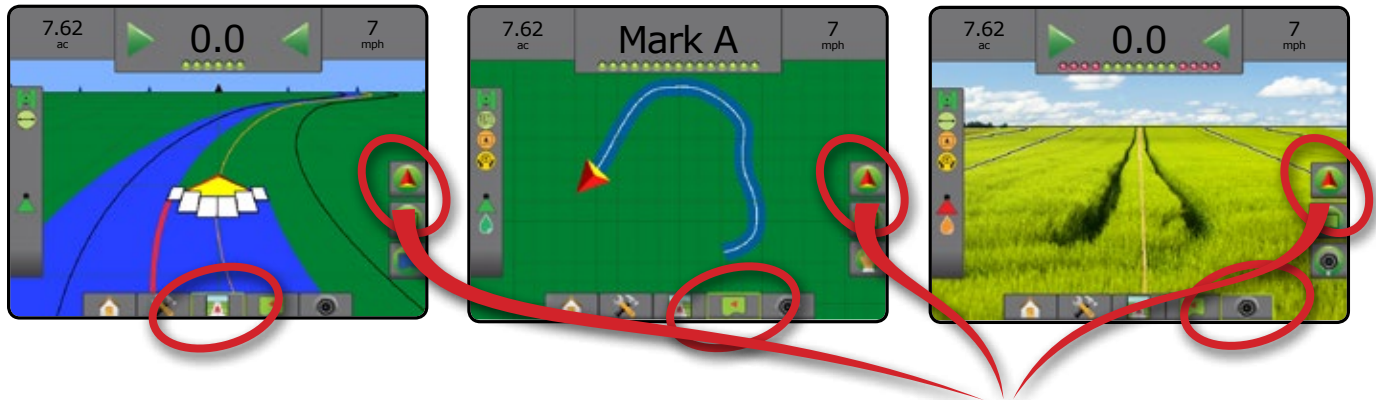

Vehicle View Guidance creates a computer-generated image of the vehicle position displayed in the application area.

Field View Guidance creates a computer-generated image of vehicle position and application area from an aerial perspective.

RealView Guidance allows live video input to be displayed instead of a computer-generated image.



To choose a Guidance Mode:

1. Press NAVIGATION AND GUIDANCE OPTIONS tab  to display navigation options.
2. Press GUIDANCE MODE icon .
3. Select from:
 - ▶ No Guidance 
 - ▶ Straight AB Guidance 
 - ▶ Curved AB Guidance 
 - ▶ Circle Pivot Guidance 
 - ▶ Last Pass Guidance* 
 - ▶ NextRow Guidance* 
 - ▶ Adaptive Curve 

*Guidance options may not be available depending on assisted/automatic steering system installed.

Figure 1-1: Choose a Guidance Mode

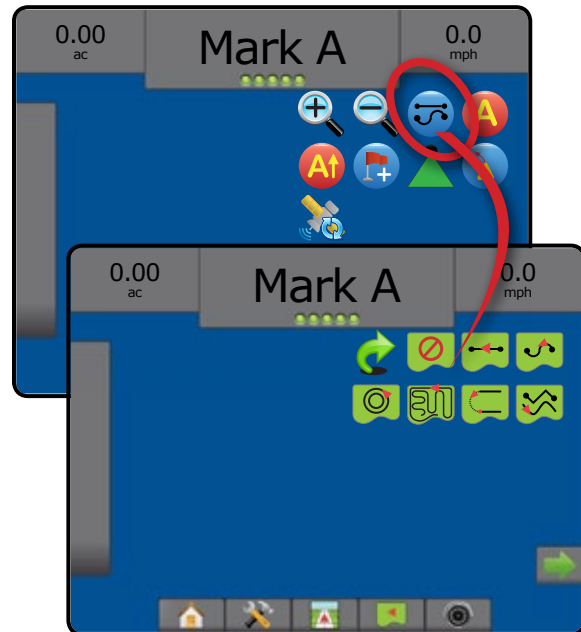

Screens Options

Guidance and navigation can be accessed from the Vehicle view screen, Field view screen, or RealView screen.





- Navigation and Guidance options tab  – on any guidance screen, displays navigation options including guidance modes, guideline options, return to point options, refresh GNSS, BoomPilot toggle, curved lookahead toggle and nozzle flow monitor reset.
- Boundary & Polygon options tab  – on any guidance screen, displays exterior boundary, interior boundary and polygon options.
- Mapping options tab  – on vehicle view or field view guidance screens, displays polygon maps, coverage maps and application maps.
- Screen options tab  – on field view guidance screen, displays zoom and pan options.
- RealView options tab  – on RealView guidance screen, displays camera setup and guidance over video options.

Figure 1-2: Guidance Screen Options







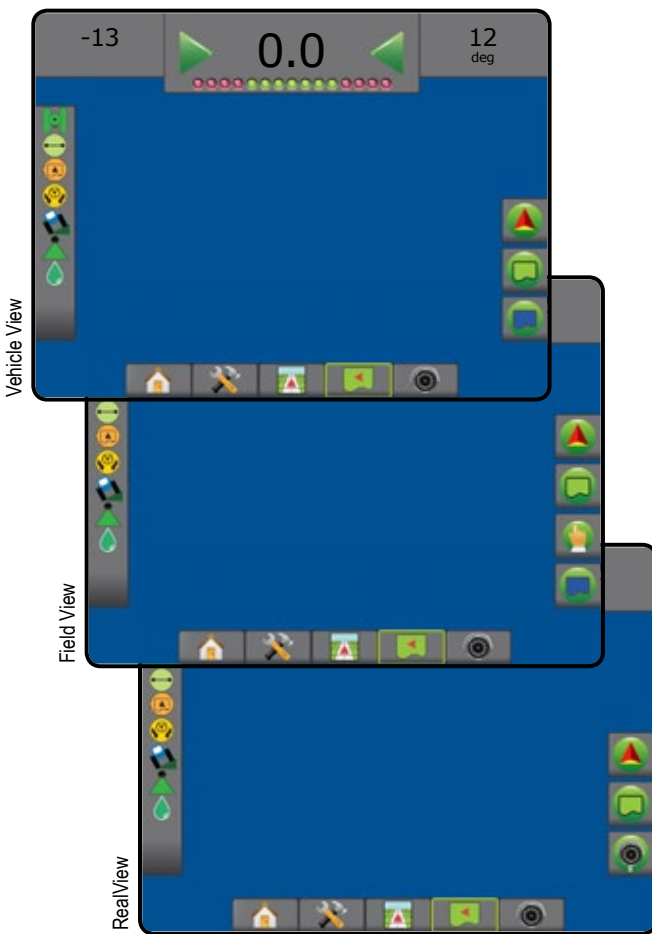
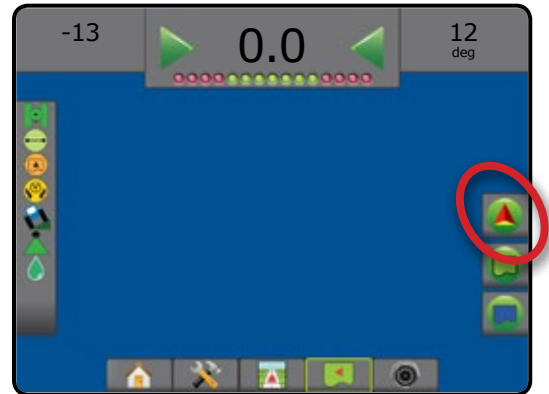









Navigation and Guidance Options





On any guidance screen, displays navigation options including guidance modes, guideline options, return to point options, refresh GNSS, BoomPilot toggle, curved lookahead toggle.

















Guidance Mode

	Guidance mode – access to guidance mode options
	No guidance – turns off guidance
	Straight AB guidance  – provides straight-line guidance based on A and B reference points
	Curved AB guidance  – provides guidance along curved lines based on an initial AB reference line
	Circle Pivot guidance  – provides guidance around a central location that radiates inward or outward based on an initial AB reference line
	Last Pass guidance  – offers true last-pass navigation
	NextRow guidance  – indicates where the NextRow is located, and provides guidance at row ends to the next adjacent row
	Adaptive Curve guidance  – provides guidance along a curved line based on an initial AB reference line where each adjacent guideline is drawn from the projected guidance width and heading

Guidelines

	Mark A  – marks the first point of the guideline.
	Mark B  – marks the end point of the guideline. Grayed = minimum distance has not been traveled.
	Cancel Mark A – cancels the Mark A process. Reverts to previous AB guideline (when established).

	NextRow Mark B  – marks the end point of the row.
	Azimuth Degree  – establishes a straight guideline measured by degrees clockwise from a north-south baseline. North = 0, East = 90, South = 180, West = 270.
	A+ Nudge – shifts the existing guideline to the vehicle's current position.
	Next Straight Guideline – shows the next straight AB or Azimuth degree guideline saved in the current job.
	Next Curved AB Guideline – shows the next Curved AB guideline saved in the current job.
	Next Circle Pivot Guideline – shows the next Circle pivot AB guideline saved in the current job.
	Next Adaptive Curve Guideline – shows the next Adaptive Curve AB guideline saved in the current job.

Return to Point	
	Mark Point  – establishes a point at the vehicle location. Grayed = GNSS is unavailable.
	Return to Point Guidance – provides distance and guidance back to an established point.
	Delete Point – deletes the Marked Point.
	Cancel Guidance – hides the distance and guidance back to the Marked Point.







BoomPilot	
	Toggles the Automatic Sprayer Control (ASC) on or off. Grayed = GNSS is unavailable.

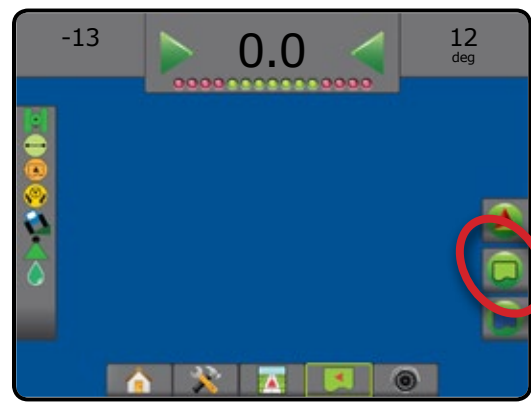





Curved Lookahead	
	Indicates where the current steering will take the vehicle using a 'pointer' as guidance.







Refresh GNSS Position	
	Resets the ClearPath filter in the OEMStar receiver.

 **Boundary and Polygon Options**
 On any guidance screen, displays exterior boundary, interior boundary and polygon options.



Exterior Boundaries	
	Mark Exterior Boundary – establishes application area and determines no-apply zones. While creating an exterior boundary, the boundary line will be to the exterior of the outermost section. Grayed = GNSS is unavailable.
	Cancel Exterior Boundary – cancels mark exterior boundary process
	Finish Exterior Boundary – finalizes current mark exterior boundary process. Boundaries can also be closed by traveling to within a swath width of the starting point.
	Pause Exterior Boundary – pauses the mark exterior boundary process
	Resume Exterior Boundary – resumes the mark exterior boundary process
	Delete Last Marked Boundary – deletes the last marked boundary (interior or exterior) from the current job. Press again to remove additional boundaries in order from last to first created

Interior boundaries	
	Mark Interior Boundary – establishes application area and determines no-apply zones. While creating an interior boundary, the boundary line will be to the interior of the innermost section. Grayed = GNSS is unavailable.
	Cancel Interior Boundary – cancels current mark interior boundary process
	Finish Interior Boundary – finalizes current mark interior boundary process. Boundaries can also be closed by traveling to within a swath width of the starting point
	Pause Interior Boundary – pauses the mark interior boundary process
	Resume Interior Boundary – resumes the mark interior boundary process
	Delete Last Marked Boundary – deletes the last marked boundary (interior or exterior) from the current job. Press again to remove additional boundaries in order from last to first created







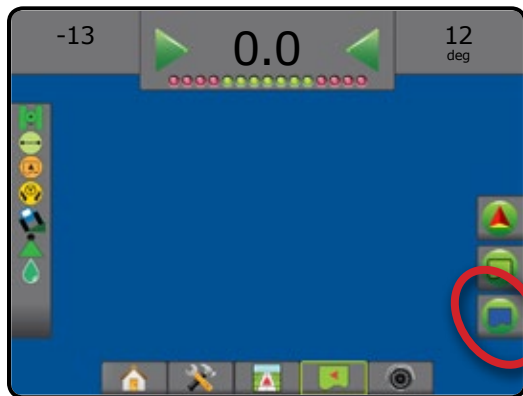

Polygons	
	Mark Polygon – establishes mapping areas. Grayed = GNSS is unavailable.
	Cancel polygon – cancels current mark polygon process
	Finish Polygon – finalizes current mark polygon process
	Pause Polygon – pauses the mark polygon process
	Resume Polygon – resumes the mark polygon process
	Delete Last Marked Polygon – deletes the last marked polygon from the current job. Press again to remove additional polygons in order from last to first created

Mapping Options

On vehicle view or field view guidance screens, displays polygon maps, coverage maps and application maps.

NOTE: Options are available only when a rate controller is on the system or a polygon has been established.



	Coverage Map – shows areas covered by the implement, regardless of whether product was applied.
	Polygon Map – shows all mapped polygons
	Prescription Map – shows pre-loaded map that provides information to the rate controller for use in applying product
	Application Map – shows where product has been applied, using color to indicate level in proportion to preset maximum and minimum levels
	Target Rate Map – shows the application rate that the rate controller will attempt to achieve (can be monitored from the Rate Control bottom tab)
	Icons – to be used on the Matrix Pro 570GS
	Buttons – to be used on the Matrix Pro 840GS
	Vehicle View – icons or buttons adjust the vehicle's view or perspective to the horizon from vehicle view to bird's eye view 
	Field View – icons or buttons increase/decrease the area displayed on the screen 

Screen Options

On field view guidance screen, displays zoom and pan options.

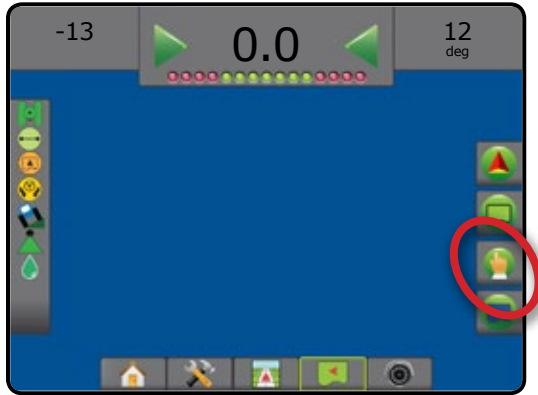

Zoom in/out



Icons – to be used on the Matrix Pro 570GS



Buttons – to be used on the Matrix Pro 840GS

Vehicle View – icons or buttons adjust the vehicle's view or perspective to the horizon from vehicle view to bird's eye view



Field View – icons or buttons increase/decrease the area displayed on the screen



Pan



Arrows – move the displayed map area in the corresponding direction without moving the vehicle.



World View – extends the screen view to the widest area available.

RealView Guidance Options

On RealView guidance screen, displays camera setup and guidance over video options.

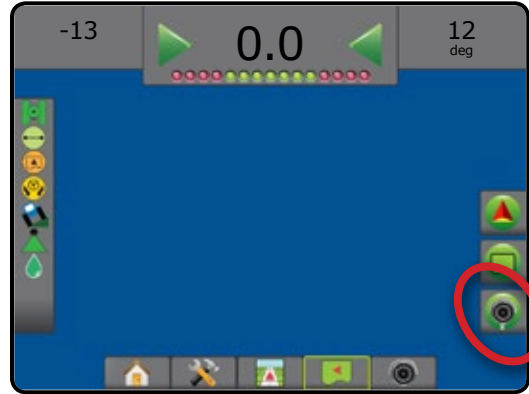

Video Camera Select – selects one of up to eight camera views if a Video selection module (VSM) is attached.



Split Camera View – selects one of two sets of four camera inputs (A/B/C/D or E/F/G/H) to divide the screen into four separate video feeds.



Guidance Over Video Setup – access to turn on Guidance over video or Steering angle and adjust guidelines.



Guidance Over Video – places three-dimensional guidelines over the video feed for navigational assistance.



Steering Angle – displays the direction in which the steering wheel needs to be adjusted.



Up & Down Icons – used to adjust the guidance lines and horizon line to match the camera's view.



Camera Image Capture – saves a still photo of the current view on the screen to a USB drive.

GUIDANCE BAR

The Guidance bar keeps you informed of your choice of selectable information, navigation activity, and section status.

Navigation Activity & Boom Status

GNSS Status – displays “No GNSS” when GNSS is unavailable, or “Slow GNSS” when GNSS is receiving GGA data at less than 5Hz

Cross Track Error – displays the distance from your desired guideline

Current Activity – displays activities such as mark an A or B point, approaching the end of a row, indicating to turn now, and distance to return to a marked point

Section Status – one dot is displayed for each section programed: a green dot indicates the section is active, and a red dot indicates the section is not active

Figure 1-3: Navigation Activity/Section Status

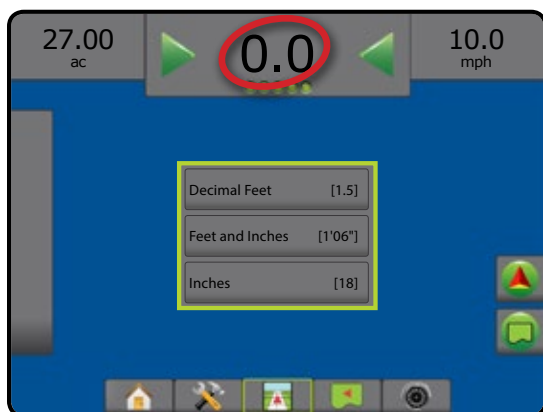

Cross Track Error

The distance around the guideline that is perceived as zero error can be adjusted using Configuration-> Guidance-> Guidance Sensitivity.

To change the format in which the distance is displayed:

1. Press the Navigation Activity box on the guidance bar.
2. Select the measurement format.

Selectable Information

Speed – displays the current speed of travel

Heading – displays the course of travel based clockwise from a true north baseline. North = 0°, East = 90°, South = 180°, West = 270°.

Total Applied Area – displays the total accumulated area that has had product applied, including double-coverage areas

Application Time – displays the total time application is active during the current job

Time – displays the current time based on the selected time zone

Swath Number – displays the current swath number in reference to the initial AB guidance line, facing in the direction from A to B. Number will be positive when the vehicle is to the right of the AB baseline, or negative when the vehicle is to the left of the AB baseline.

System Pressure – displays the current system pressure (available only when an Input/Output Module is on the system)

Droplet Size – displays the current tip droplet size (available only when an Input/Output Module is on the system)

Actual Application Rate – displays the current application rate (available only when a third-party rate controller is on the system)

Target Application Rate – displays the target application rate (available only when a third-party rate controller is on the system)

Figure 1-4: Selectable Information

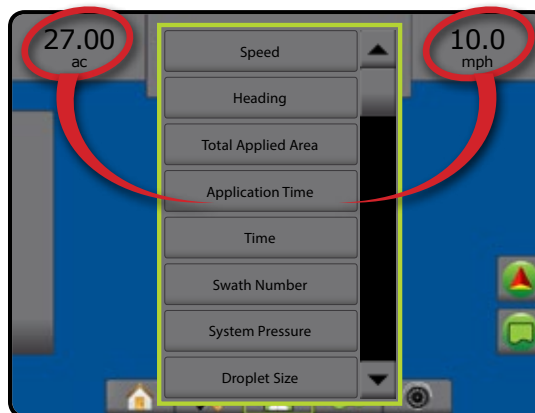

STATUS BAR

The Status Bar provides information on GNSS status, guidance mode, boundary area, assisted/auto steering engagement, tilt correction, implement control status, droplet/pressure status, tip flow status, and rate control status.

When an icon is pressed, the related status information is displayed.

Figure 1-5: Status Bar

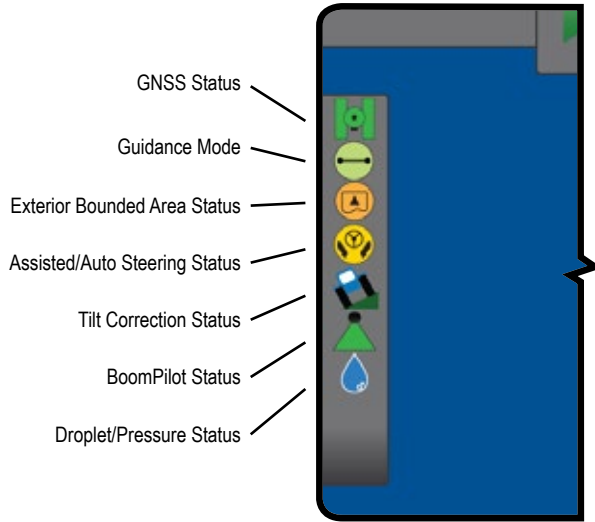

GNSS Status

- Green = GPS, GLONASS, or SBAS (with or without DGPS Required)
- Yellow = GPS only
- Red = no GNSS
- Orange = Glide/ClearPath

Guidance Mode

- No Icon = no Guidance
- Straight AB Guidance
- Curved AB Guidance
- Circle Pivot Guidance
- Last Pass Guidance
- NextRow Guidance
- Adaptive Curve Guidance

Exterior Bounded Area Status

- Outside Exterior Boundary = traveling outside exterior bounded area
- Inside Exterior Boundary = traveling inside exterior bounded area
- No Icon = no exterior boundary established

Assisted/Auto Steering Status

- Green = engaged, actively steering
- Yellow = enabled, all conditions have been met to allow for assisted/auto steering
- Red = disabled, all conditions have not been met to allow for assisted/auto steering
- No Icon = no assisted/auto steering system installed

Tilt Correction Status

- Colored = engaged, actively applying tilt correction
- Red = disabled
- No Icon = no tilt gyro module installed on system, or tilt is associated with assisted/auto steering system

BoomPilot Status

- Green = automatic
- Yellow = all on
- Red = off/manual
- No Icon = single section (no SmartCable or SDM installed on system)

Droplet/Pressure Status

- Colored = engaged. The color of the droplet is directly associated with the current droplet size. Color options include:
- Crossed Out = disabled
- No Icon = no Pressure Sensor Interface Kit installed, no pressure sensor monitor on the DCM

Status/Information Screens

GNSS Status

GNSS Status displays information regarding current GNSS status, including data rates, number of satellites in view, HDOP and PRN status, receiver and version, satellite quality and ID, and UTM zone.

1. Press GNSS STATUS icon



Guidance Mode Status

Guidance Mode Status displays information regarding the pattern of guidance, the name of the current guideline, and how many guidelines are saved in the console.

1. Press GUIDANCE MODE icon      .

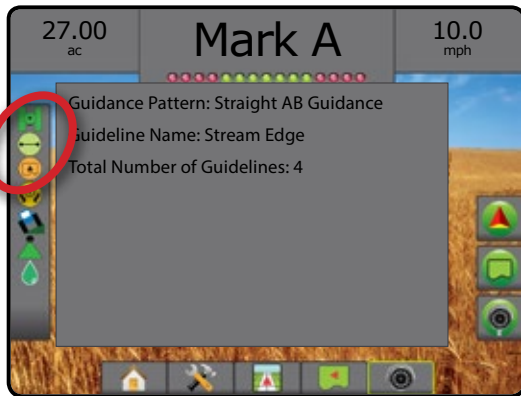

Tilt Correction Status

Tilt Correction Status displays information regarding the current status of the tilt correction system.

1. Press TILT CORRECTION STATUS icon  .



Exterior Bounded Area Status

Exterior Bounded Area Status displays information regarding the areas in the current exterior boundaries.

1. Press EXTERIOR BOUNDED AREA icon  .



BoomPilot Status

BoomPilot Status displays information regarding the current status of the BoomPilot system.

1. Press BOOMPILOT STATUS icon   .



Assisted/Auto Steering Status

Assisted/Auto Steering Status displays information regarding the current status of the assisted/auto steering system, including tilt status.

1. Press ASSISTED/AUTO STEERING STATUS icon   .



Droplet/Pressure Status

Droplet/Pressure Status displays information regarding the current status of the droplet size and system pressure.

1. Press DROPLET/PRESSURE STATUS icon



NAVIGATION SCREENS

Vehicle View

Vehicle view creates a computer-generated image of the vehicle position displayed in the application area. From this screen all setup, boundary, polygon, mapping, application and navigation options can be accessed via the options tabs on the right side of the screen.

To access the Vehicle view screen:

1. Press VEHICLE VIEW GUIDANCE tab .

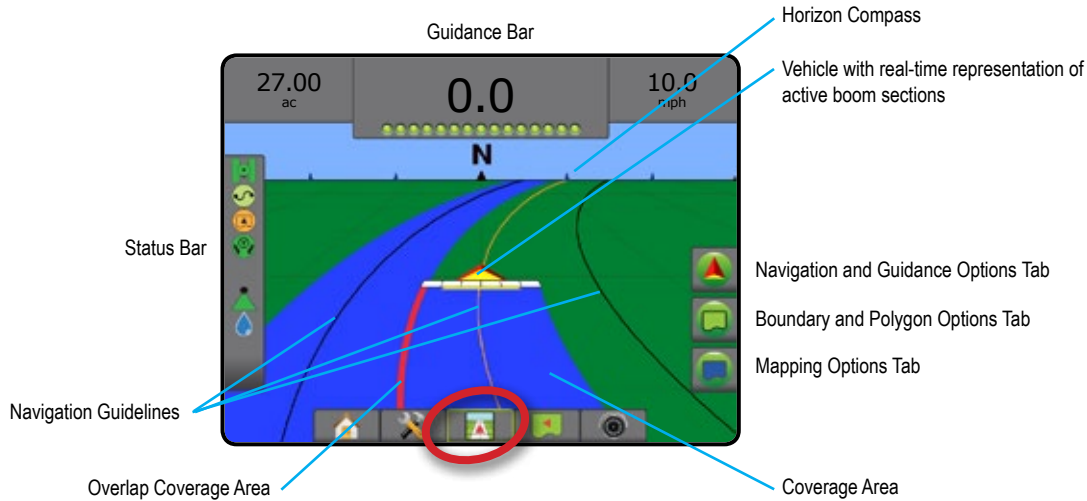

Figure 1-6: Vehicle View



On Screen Guidance

- Guidelines
 - ◀ Orange – active guidance line
 - ◀ Black (multiple) – adjacent guidance lines
 - ◀ Black – exterior boundary line
 - ◀ Gray – interior boundary line
 - ◀ Blue – polygon boundary line
- Points – markers for established points
 - ◀ Red Point – Return to point
 - ◀ Blue Point – Mark A
 - ◀ Green Point – Mark B
- Horizon Compass – general heading can be displayed on horizon (when zoomed in)
- Coverage Area – illustrates applied area and overlap:
 - ◀ Blue – one application
 - ◀ Red – two or more applications.
- Sections
 - ◀ Empty Boxes – inactive sections
 - ◀ White Boxes – active sections

Matrix Pro 840GS Console Button Assistance

- Zoom In/Out & Perspective – the Up/Down buttons   adjust the vehicle's view or perspective to the horizon from vehicle view to bird's eye view.

Field View

 Field View creates a computer-generated image of the vehicle position and application area from an aerial perspective. From this screen, all setup, boundary, polygon and navigation options, as well as Pan Mode and mapping options, can be accessed via the Option tabs on the right side of the screen.

To access the Field View screen:

1. Press FIELD VIEW GUIDANCE tab .

Figure 1-7: Field View

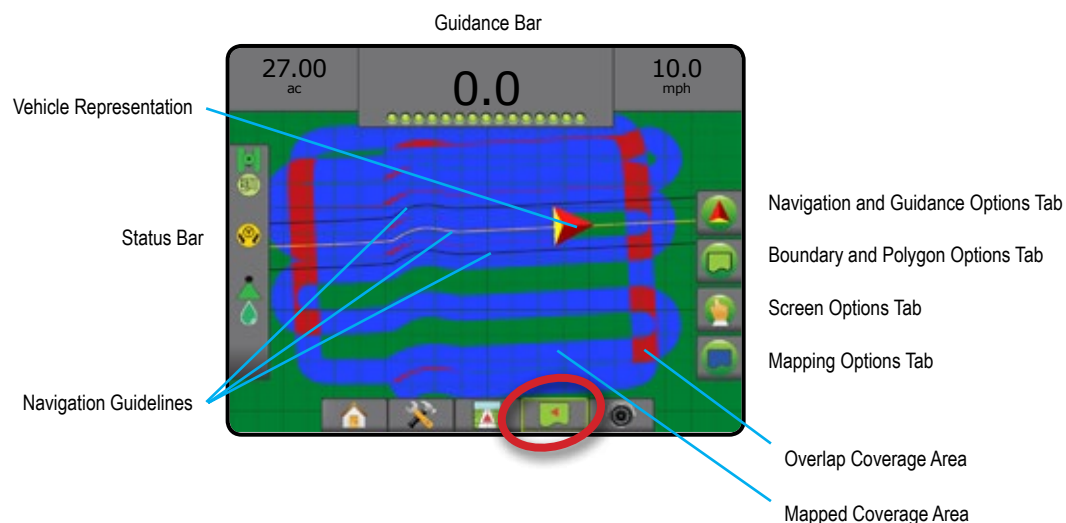

On Screen Guidance

- Guidelines
 - ◀ Orange – active guidance line
 - ◀ Black (multiple) – adjacent guidance lines
 - ◀ Black – boundary line
 - ◀ Gray - interior boundary line
 - ◀ Blue - polygon boundary line
- Points – markers for established points
 - ◀ Red Point – Return to Point
 - ◀ Blue Point – Mark A
 - ◀ Green Point – Mark B
- Coverage Area – illustrates applied area and overlap
 - ◀ Blue – one application
 - ◀ Red – two or more applications

Matrix Pro 840GS console button assistance

- Zoom In/Out – the Up/Down buttons   adjust the map's visible area.

RealView Guidance

 RealView Guidance allows live video input to be displayed instead of a computer-generated image. From this screen all setup, boundary, polygon and navigation options can be accessed via the tabs on the right side of the screen. To adjust the camera view [reverse, upside down], go to Setup-> Configuration-> Video.

- ▶ Single Camera – a single camera is directly attached to the console
- ▶ Video Selection Module – if a Video Selection Module (VSM) is installed on the system, two (2) video options are available:
 - One Camera View – one of up to eight camera inputs can be selected to change the view of the video input.
 - Split Camera View – one of two sets of four camera inputs (A/B/C/D or E/F/G/H) can be selected to divide the screen into four separate video feeds.

To access the RealView screen:

1. Press REALVIEW GUIDANCE tab .

Figure 1-8: RealView Guidance

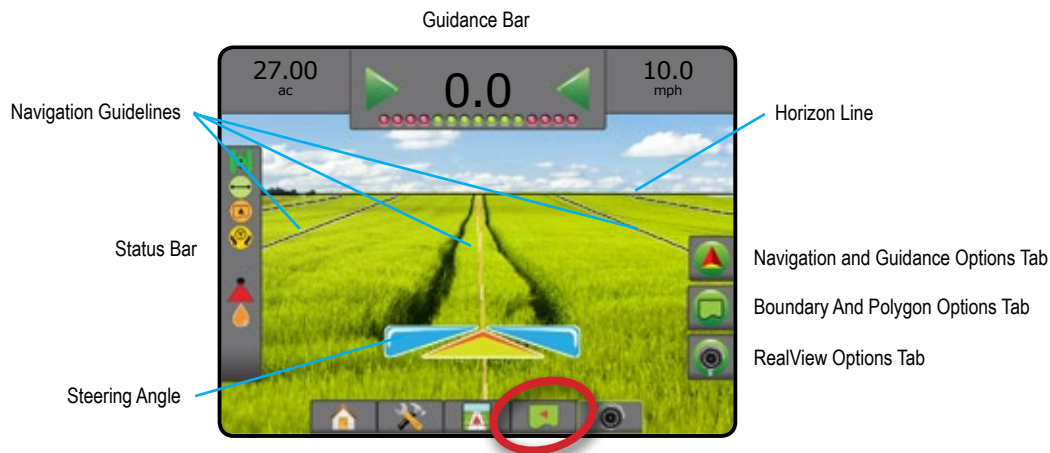

On screen guidance

- Guidelines
 - ◀ Orange – active guidance line
 - ◀ Black (multiple) – adjacent guidance lines
 - ◀ Horizontal Black Line – adjustable horizon line
 - ◀ Black – exterior boundary line
 - ◀ Gray – interior boundary line
 - ◀ Blue – polygon boundary line



GUIDANCE MODES

	<h3>Straight AB Guidance</h3> <p>Straight AB Guidance provides straight-line guidance based on A and B reference points. The original A and B points are used to calculate all other parallel guidelines.</p> <p><i>NOTE: Offset to adjacent guidelines will be calculated using the guidance width: see "Configuration-> Mapping and guidance" in the System setup chapter.</i></p>	
	<h3>Curved AB Guidance</h3> <p>Curved AB Guidance provides guidance along curved lines based on an initial AB reference line. This initial baseline is used to calculate all other guidelines.</p> <p><i>NOTE: Curved guidance is recommended not to exceed 30° within the AB guideline.</i></p> <p><i>Offset to adjacent guidelines will be calculated using the guidance width: see "Configuration-> Mapping and Guidance" in the System setup chapter.</i></p> <p><i>HINT: While working in a bounded area, the guidance pattern extending beyond the established AB points will be straight-line guidance.</i></p>	
	<h3>Adaptive Curve AB Guidance</h3> <p>Adaptive Curve Guidance* provides guidance along a curved line based on an initial AB reference line where each adjacent guideline is drawn from the projected guidance width and heading.</p> <p><i>NOTE: Offset to adjacent guidelines will be calculated using the guidance width: see "Configuration-> Mapping and Guidance" in the System setup chapter.</i></p>	
	<h3>Circle Pivot Guidance</h3> <p>Circle pivot guidance provides guidance around a central location that radiates inward or outward based on an initial AB reference line. This initial baseline is used to calculate all other guidelines.</p> <p>It is used for product application in a centre pivot field while being guided along a circular guideline that matches a centre pivot irrigation system radius.</p> <p><i>NOTE: Offset to adjacent guidelines will be calculated using the guidance width: see "Configuration-> Mapping and Guidance" in the System setup chapter.</i></p>	
	<h3>Last Pass Guidance</h3> <p>Last pass guidance* offers true last-pass navigation. The console will automatically detect the nearest applied area and establish parallel guidelines based on that area.</p> <p><i>NOTE: If a boundary is established but no application occurred during the boundary process, guidance will not initiate.</i></p>	



NextRow Guidance

NextRow guidance* indicates where the NextRow is located, and provides guidance at row ends to the next adjacent row. When the operator marks the end of the row and begins turning to the next row, a Straight AB guidance line is provided in the next row. When the vehicle is in the NextRow, guidance is turned off.

NOTE: Offset to NextRow will be calculated using the guidance width: see "Configuration-> Mapping and Guidance" in the System setup chapter.
The NextRow Guidance does not support skipping rows.

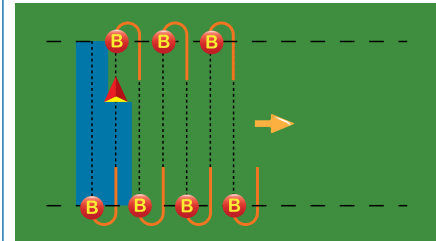

No Guidance

No guidance* turns off guidance.

NOTE: No guidance mode does not delete established guide lines or points from the console. To delete established/saved data from the console, see "Data management" in the System setup chapter.

*Guidance options may not be available depending on assisted/automatic steering system installed.

Adjacent rows may be skipped in Straight AB guidance, Curved AB guidance, Adaptive curve guidance and Circle pivot guidance. Last pass guidance and NextRow guidance do not support skipping adjacent rows.

GUIDELINES

AB guidelines, Azimuth guidelines, next pass guidelines, and NextRow guidelines are each available depending on the current guidance mode. Switching from one guidance mode to another will change the current available guidelines.

Multiple guidelines can be created in each guidance mode. If more than one guideline is saved in a single guidance mode, the Next Guideline feature will become available. By pressing the Next guideline option, the vehicle will be directed to the next guideline saved in the console.

A user can duplicate and edit jobs for reuse of guidelines, boundaries, applied data, prescription map and/or polygons for different applications over the same field using Fieldware Link or the Data -> Job data -> Manage option.

Marking A and B Points

To establish an AB guideline:

1. Drive to the desired location of Point A .
2. Press NAVIGATION AND GUIDANCE OPTIONS tab to display navigation options.
3. Press MARK A icon .
4. Drive to the desired location of Point B .
5. Press MARK B icon to establish the AB line.
6. "Would you like to name this guideline?"
 Press:
 - ▶ Yes – to enter a name and save the guideline in the console
 - ▶ No – to automatically generate a name and save the guideline in the console

The console will begin providing navigation information.

NOTE: The MARK B Icon is not available for selection (grayed out) until the minimum distance is traveled (3.0 metres in Straight, Curved or Adaptive curve guidance; 50.0 metres in Circle pivot guidance).

NOTE: It is not necessary to drive the entire circumference of the centre pivot in order to initiate Circle pivot guidance.

Use CANCEL MARK icon to cancel the Mark A command and revert to the previous guideline (when established).

Figure 1-9: Mark A Point



Figure 1-10: Mark B Point



Figure 1-11: Save Guideline



Figure 1-12: Follow Guidance

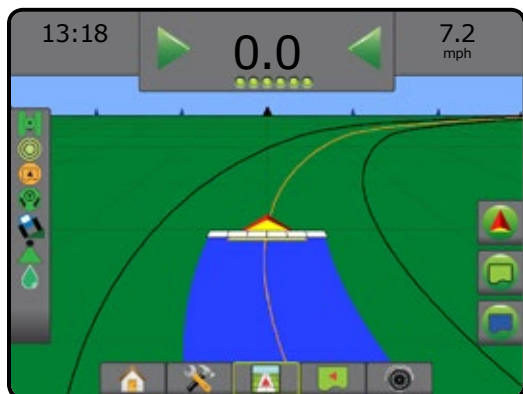

A+ Nudge Feature

A+ The A+ Nudge Feature allows the current guideline to be shifted to the vehicle's current location.

NOTE: Available only when in Straight AB or Curved AB Guidance.

To adjust the guideline:







1. Press NAVIGATION AND GUIDANCE OPTIONS tab  to display navigation options.
2. Press A+ NUDGE icon .

Figure 1-13: A+ Nudge



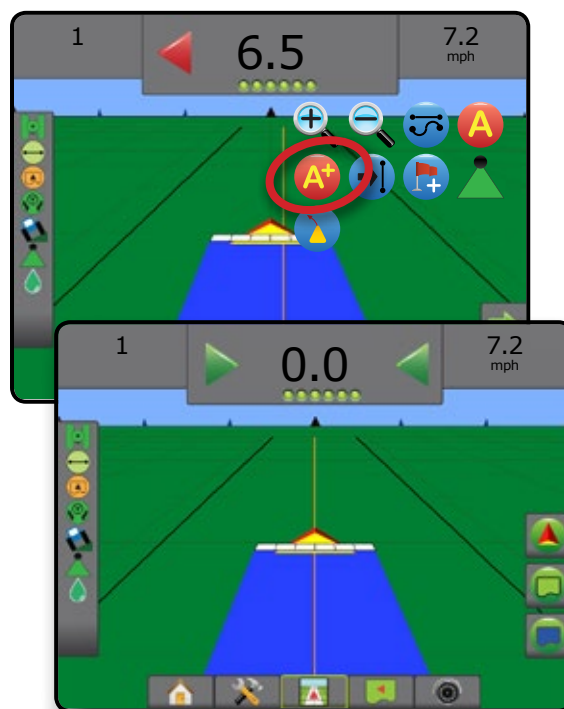

Next Guideline Feature

If more than one guideline is saved, the Next guideline feature will become available. By pressing the Next guideline option, the vehicle will be directed to the next guideline saved in the console.

- Next Straight Guideline  – shows the next straight AB or Azimuth degree guideline saved in the current job.
- Next Curved Ab Guideline  – shows the next Curved AB guideline saved in the current job.
- Next Circle Pivot Guideline  – shows the next Circle pivot AB guideline saved in the current job.
- Next Adaptive Curve Guideline  – shows the next Adaptive Curve AB guideline saved in the current job.

NOTE: Offset to adjacent guidelines will be calculated using the guidance width. See “Configuration->Mapping and Guidance” in the System setup chapter.

To change to other available guidelines:

1. Press NAVIGATION AND GUIDANCE OPTIONS tab  to display navigation options.
2. Press NEXT GUIDELINE icon .

Toggle between all guidelines by pressing the NEXT GUIDELINE icon  again.

Figure 1-14: Next Guideline



To view which guideline is active, press the Guidance mode icon on the Status bar.

Figure 1-15: View which guideline is active

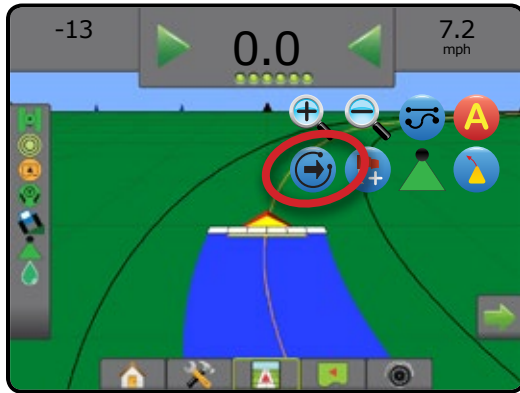
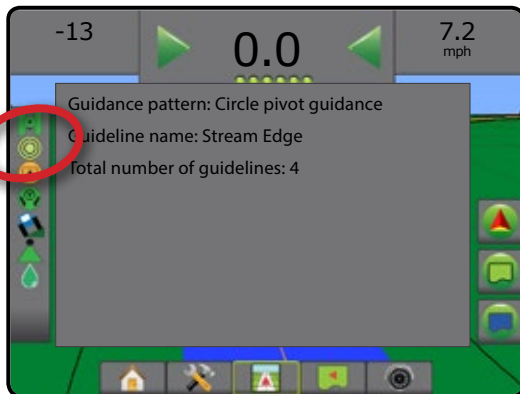

Last Pass Guidelines

 Last pass guidance offers true last-pass navigation. The console will automatically detect the nearest applied area and establish parallel guideline based on that area.

NOTE: Last pass guidance may not be available depending on assisted/automatic steering system installed.

To activate Last pass guidelines:

1. Drive to a desired location to apply the first pass.
2. Travel next to the applied area.
3. The console will begin providing navigation information.

NOTE: If a boundary is established but no application occurred during the boundary process, guidance will not initiate.

Figure 1-16: Apply First Pass



Figure 1-17: Follow Guidance

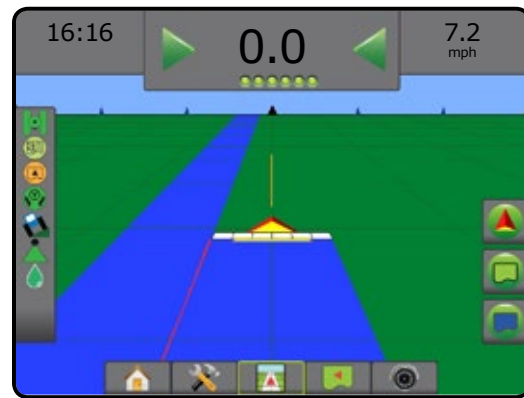



NextRow Guidelines

 NextRow Guidance indicates where the next row is located based on the programmed guidance width, and provides manual guidance information at user-marked row ends to the next adjacent row. When the operator signals the end of the row, a Straight AB line will be established in the current row and guidance provided to the NextRow. Once the vehicle has entered into the next row, no guidance or guidelines are shown.

NOTE: Offset to NextRow will be calculated using the guidance width: see "Configuration->Mapping and Guidance" in the System setup chapter.

NOTE: NextRow guidance may not be available depending on assisted/automatic steering system installed.

To activate NextRow Guidelines:

1. Press NAVIGATION AND GUIDANCE OPTIONS tab  to display navigation options.
2. At the end of a row (while driving a straight line) press MARK B icon .
 - ◀The end of the row will be marked with a green point .
3. Turn toward the next row.
4. Based on that direction turned, guidance will be provided for the next adjacent row.
 - ◀When the vehicle is in the row, the guideline is removed.
5. Repeat at the end of the next row.

NOTE: The NextRow guidance feature does not support skipping rows.

Figure 1-18: Mark End of Row

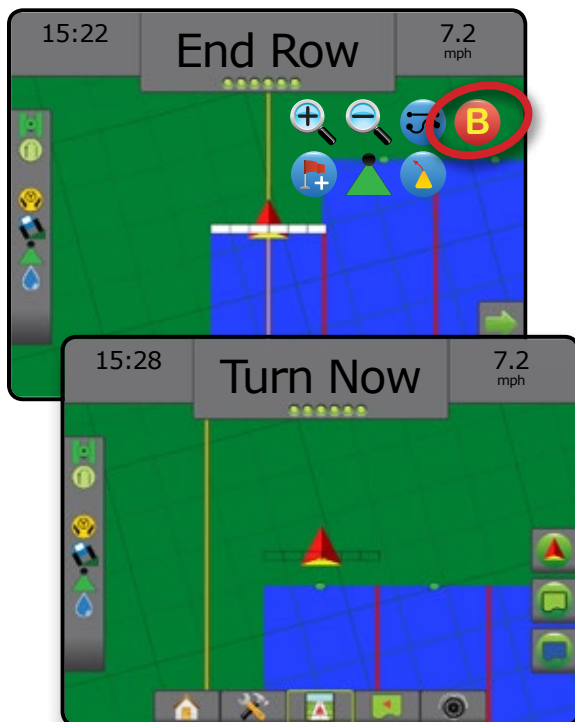



Azimuth Degree

 An azimuth is defined as a horizontal angle measured clockwise from a true north baseline. When using an azimuth, the point from which the azimuth originates is the centre of an imaginary circle. North = 0°, East = 90°, South = 180°, West = 270°.

Azimuth degree guidance projects a guideline between the current vehicle position (the A point) and a B point set 100 metres away along the entered azimuth heading.

To establish an Azimuth degree guideline:

1. Press NAVIGATION AND GUIDANCE OPTIONS tab  to display navigation options.
2. Press AZIMUTH icon  to enter azimuth degree.
3. Use the entry screen to establish the azimuth degree.
4. "Would you like to name this guideline?"

Press:

- ▶ Yes – to enter a name and save the guideline
- ▶ No – to automatically generate a name

The console will begin providing navigation information.

To establish additional azimuth guidelines, follow the same steps as the initial azimuth guideline.

Figure 1-19: Azimuth Guidance



RETURN TO POINT

Return to point provides guidance back to an established point in Vehicle view and Field view. In Vehicle view an arrow directs the vehicle back to the established point. In Field view only the point is displayed.

A return point is job-specific, and will remain active in the active job until canceled.

NOTE: Return to point guidance may not be available depending on assisted/automatic steering system installed.

Marking a Return Point

To mark a return point:





1. Drive to the desired location of return point .
2. Press NAVIGATION AND GUIDANCE OPTIONS tab  to display navigation options.
3. Press ADD POINT icon .

Figure 1-20: Return point established – Vehicle View

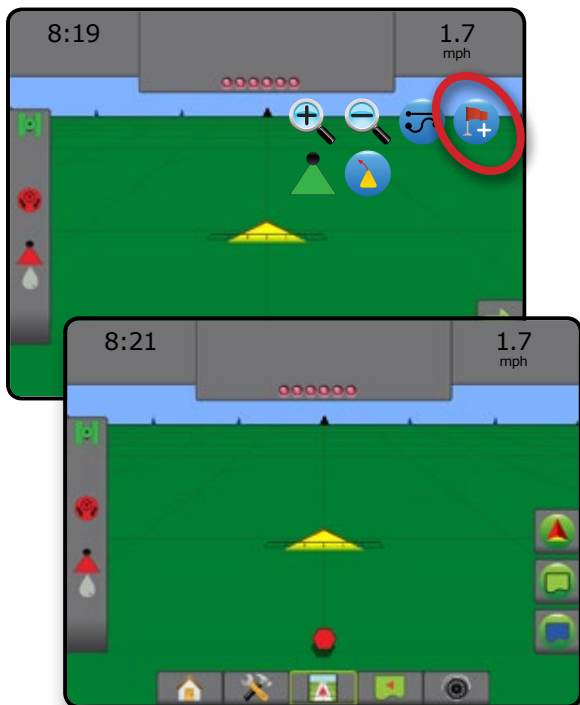

Delete the Return Point

To delete the established return point:

1. Press NAVIGATION AND GUIDANCE OPTIONS tab  to display navigation options.
2. Press DELETE POINT icon .



Delete Point icon is not available while return to point guidance is active.

Figure 1-21: Delete point



Guidance to a Return Point

To show distance and guidance to the established return point:

1. Press NAVIGATION AND GUIDANCE OPTIONS tab  to display navigation options.
2. Press the RETURN TO POINT GUIDANCE icon .

The console will begin providing the distance information on the Guidance bar from the vehicle to the established point.

Use CANCEL RETURN TO POINT GUIDANCE icon  to hide distance and guidance to the established point.

Guidance cannot be calculated when “?” appears in the guidance bar.

Figure 1-22: Return to point guidance – Vehicle View



BOOMPILOT

Depending on if there is a section control system present and when present what kind of section control is being used as well as what options are enabled, there are multiple options for BoomPilot section control.

This section includes setup options for these configurations:

- ▶ No Section Control Module
 - Console Only
 - With Optional Work On/Off Switch
- ▶ With TeeJet Section Control Module and Switchbox or ISM
- ▶ With TeeJet Section Control Module



Figure 1-23: BoomPilot Icon and Status Bar Indicator



No Section Control Module

If a section control system is not present, the BoomPilot Icon or an optional work on/off switch is used to turn the single section on or off. Only one section width will be illustrated and the status bar will have no icon.



NOTE: If an ISOBUS controller, SmartCable, Section Driver Module (SDM), or Switch Function Module (SFM) is present, please refer to the following sections for more information.

NOTE: The BOOMPILOT icon is gray  when GNSS is unavailable. BoomPilot status bar icon will be off/manual .

Console Only

The BoomPilot Icon is used to turn the section on or off.

To set configuration settings:

1. Press SYSTEM SETUP bottom tab .
2. Press CONFIGURATION side tab .
3. Press **Implement**.
4. Set "BoomPilot Icon" to **Enable**.

NOTE: BoomPilot Start Mode setting will make no difference in the function of this option.

To switch application off or on using the console:



1. Press NAVIGATION AND GUIDANCE OPTIONS tab  to display navigation options.

2. Press BOOMPILOT icon .
3. Press BOOMPILOT icon  to toggle the section on or off.

With Optional Work On/Off Switch

The work on/off switch is used to turn the section on or off.

To set configuration settings:

1. Press SYSTEM SETUP bottom tab .
2. Press CONFIGURATION side tab .
3. Press **Implement**.
4. Set "BoomPilot Icon" to **Disable**.

NOTE: BoomPilot Start Mode setting will make no difference in the function of this option.

In areas where application is desired:

1. Turn work on/off switch to the "on" position.

In areas where application is not desired:

1. Turn work on/off switch to the "off" position.



Using the Console

To control the section using the BoomPilot Icon while there is a work on/off switch on the system:

1. Set "BoomPilot Icon" to **Enable**.
2. Work on/off switch should remain in the "off" position.
3. Press BOOMPILOT icon .

With TeeJet Section Control Module and Switchbox or ISM

SmartCable, Section Driver Module (SDM) or Switch Function Module (SFM) and a switchbox or Implement Status Module (ISM) is present.

NOTE: The BOOMPILOT icon is gray  when GNSS is unavailable. BoomPilot status bar icon will be off/manual .

To switch application off or on automatically:



1. Automatic/Manual Boom Switch must be in the "Auto" position.
 - ◀ Automatic – status bar icon will be green 
2. Master Switch and section switches must be in the "On" position.



NOTE: Application can be manually controlled while in Automatic BoomPilot mode using the switches on the switchbox or switches connected to the ISM.

To switch application off or on manually:





1. Automatic/Manual Boom Switch must be in the "Manual" position.
 - ◀ Manual – status bar icon will be red 
2. Use the switches on the switchbox or switches connected to the ISM.

With TeeJet Section Control Module



SmartCable, Section Driver Module (SDM) or Switch Function Module (SFM) is present BoomPilot is used to set automatic section control to off/manual , automatic , or spot application 

NOTE: The BOOMPILOT icon is gray  when GNSS is unavailable. BoomPilot status bar icon will be off/manual .

To switch application off or on automatically:

1. Press NAVIGATION AND GUIDANCE OPTIONS tab  to display navigation options.
2. Press and release BOOMPILOT icon .
 - ◀Enable – status bar icon will change to green 
 - ◀Disable – status bar icon will change to red 



To apply a spot application:

1. Press NAVIGATION AND GUIDANCE OPTIONS tab  to display navigation options.
2. Press and hold BOOMPILOT icon  over area to be applied.
 - ◀Spot Application– status bar icon will change to yellow 

CURVED LOOKAHEAD

The curved lookahead guideline provides an indication of where the current steering will take the vehicle using a 'pointer' as guidance. The Curved lookahead option is available in all guidance modes.

To activate the Curved lookahead guideline:



1. Press NAVIGATION AND GUIDANCE OPTIONS tab  to display navigation options.
2. Select CURVED LOOKAHEAD icon .

The pointer will be visible on the navigation screen.

Figure 1-24: Curved Lookahead



To remove the Curved lookahead guideline:

1. Press NAVIGATION AND GUIDANCE OPTIONS tab  to display navigation options.
2. Select CURVED LOOKAHEAD icon .



REFRESH GNSS POSITION

Refresh GNSS position resets the ClearPath filter in the OEMStar receiver in cases where the user has had the receiver running in close proximity to heavy tree cover and/or buildings. See “Configuration-> GNSS receiver configuration” to activate the Refresh GNSS position icon.

NOTE: Activating the refresh while in a job will cause a momentary interruption in the relay of GNSS data. This will most likely result in sections already on in automatic BoomPilot mode to go off for a short period of time.

The refresh should not be done during active application.

To refresh the GNSS position:



1. Press NAVIGATION AND GUIDANCE OPTIONS tab  to display navigation options.
2. Select Refresh GNSS POSITION icon .

Figure 1-25: Refresh GNSS position



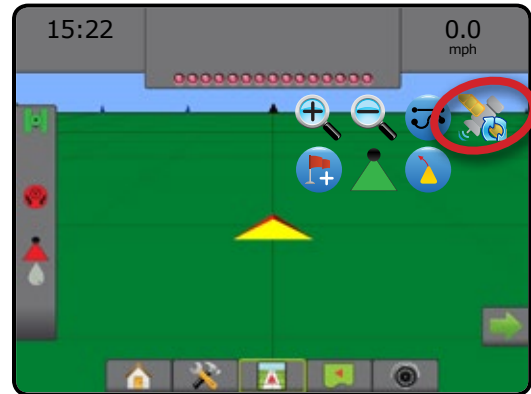

BOUNDARIES AND POLYGONS

Available on any guidance screen, the Boundaries and polygons tab displays exterior boundary, interior boundary and polygon options.



Mapping Location

Mapping location establishes the layout of the location from which the boundary or polygon will be mapped.

- ▶ **Default Location** – While creating an exterior boundary or polygon, the line will be to the exterior of the outermost active section. While creating an interior boundary, the line will be to the interior of the innermost active section. If no sections are active, the boundary will be marked to the end of the outermost section.
- ▶ **User Entry** – in-line and lateral offset from the GNSS antenna directions and distances can be specified by the user. Up to five (5) user entries can be created. See “Configuration-> Mapping and Guidance-> Mapping Location-> User Entered Mapping Location” for details.

Application is not required to map a boundary or polygon.



If mapping a boundary or polygon with one or more sections folded in and turned off, it is necessary to maintain this section configuration for the duration of the boundary or polygon pass. Any changes made to the number of sections turned on, and therefore the width of the machine after the boundary or polygon mapping process has started, will result in the application mapping the boundary or polygon at the outer edge of all the programmed sections – not necessarily those turned on at any given time during the boundary or polygon pass.

When mapping a boundary or polygon with some sections folded off, it is necessary to turn BoomPilot to Manual mode  and turn ON the master and section switches for all sections that will be used during the boundary or polygon pass. Once the boundary or polygon pass is complete the sections switches can be turned OFF, master switch remains ON, BoomPilot can be returned to Automatic mode  and automatic section control can then be used.

NOTE: If a boundary is mapped with some sections folded as described above, it may be necessary to use the A+ NUDGE icon  on the guideline over to the correct position for subsequent passes in the field.

Boundaries



Application boundaries establish the work areas where product is or is not applied while using ASC or BoomPilot.

- **Exterior Boundary**  – establishes a work area where application will be applied while using ASC or BoomPilot.
- **Interior Boundary**  – establishes a work area where application will NOT be applied while using ASC or BoomPilot.









Boundaries can be established in all guidance modes. Up to 100 total exterior boundaries and/or interior boundaries can be stored within a single job. Application is not required to map a boundary.

Using Data-> Job data-> Manage or with Fieldware Link, a user can duplicate and edit jobs for reuse of boundaries for different applications over the same field.

To establish an exterior or interior boundary:

1. Drive to a desired location at the perimeter of the application area and orientate the vehicle in association to the established mapping location. See “Configuration-> Mapping and Guidance-> Mapping Location” for details.
2. Press BOUNDARY AND POLYGON OPTIONS tab  to display boundary and polygon options.
3. Press MARK BOUNDARY icon  .
4. Verify that the Mapping location is correct.
 - ◀ If the Mapping location is not correct, press **Cancel** then go to Configuration-> Mapping and Guidance-> Mapping Location.
5. Travel the perimeter of the application area.

While traveling, use as needed:

 - ▶ **Pause Boundary**   – pauses the mark boundary process.
 - ▶ **Resume Boundary**   – resumes the mark boundary process.
 - ▶ **Cancel Boundary**   – cancels mark boundary process.
6. Finish the boundary:
 - ▶ **Automatic Close** – travel to within one swath width of the starting point. The boundary will close automatically (the white guideline will turn black).
 - ▶ **Manual Close** – press the FINISH BOUNDARY icon   to close the boundary with a straight line between the current location and the starting point.

NOTE: If the minimum distance is not traveled (five times the swath width), an error message will pop-up.
7. Press:
 - ▶ **Save** – to save the boundary
 - ▶ **Delete** – to delete the boundary

Figure 1-26: Exterior Boundary

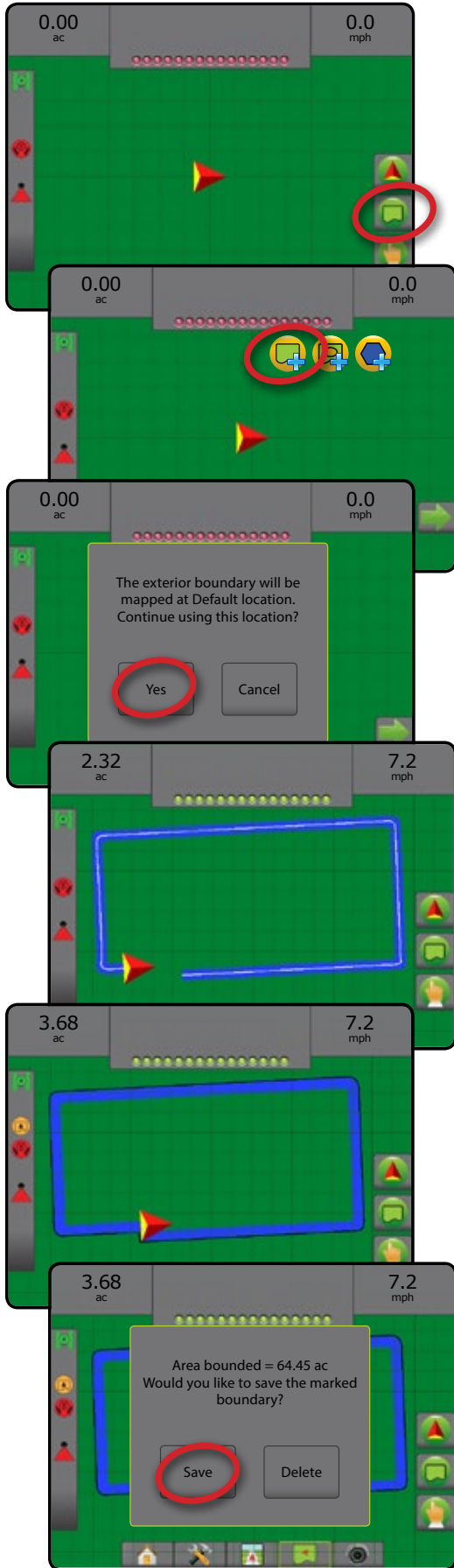
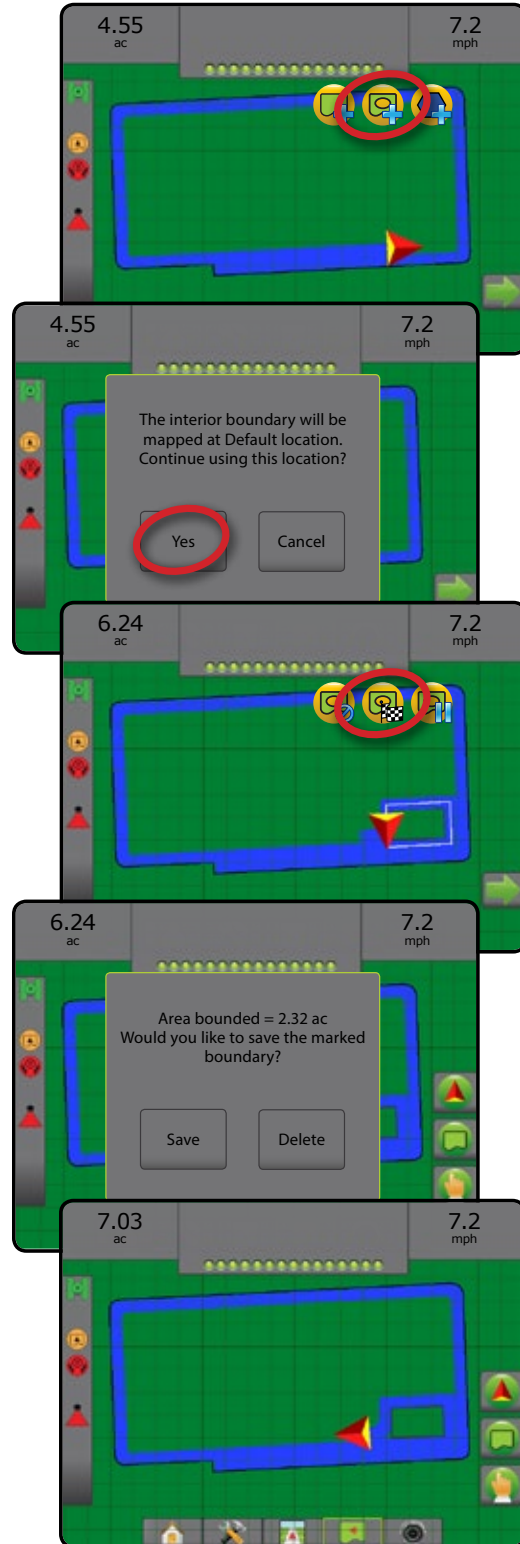

Figure 1-27: Add Interior Boundary



Delete Last Marked Boundary



Use DELETE BOUNDARY icon  to delete the last marked boundary (interior or exterior) from the current job. Press again to remove additional boundaries in order from last to first created.

Figure 1-28: Delete Last Marked Boundary

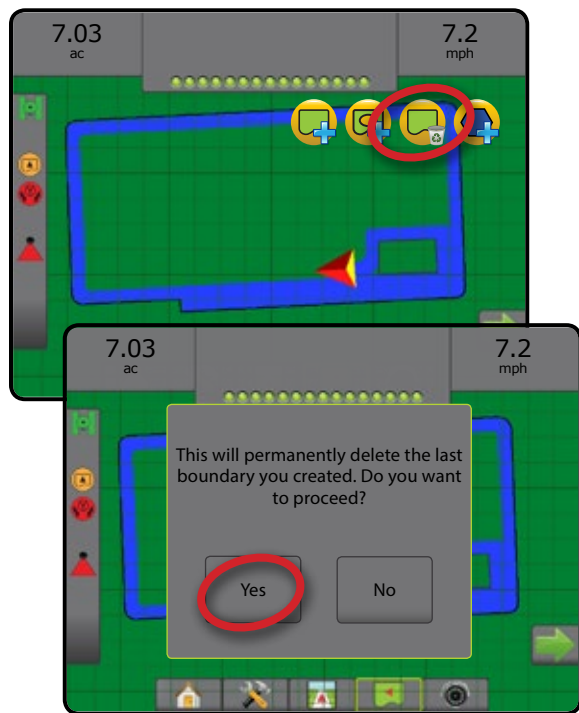

Boundary on Status Bar

In reference to your current location, the IN EXTERIOR BOUNDARY icon  or OUT OF EXTERIOR BOUNDARY icon  is displayed on the Status Bar once a boundary is established.



1. Press BOUNDED AREA icon  .
 - ◀ Working Area – total are of all exterior boundaries
 - ◀ Field Area – total area of all exterior boundaries minus the area of all interior boundaries
 - ◀ Internal Area – total area of all interior boundaries

Figure 1-29: Exterior Boundary on Status Bar



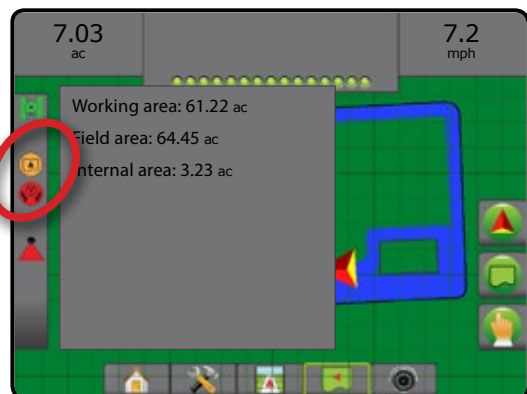

Polygons

Polygons establish mapping areas. Polygons can be established in all guidance modes. Up to 100 polygons can be stored within a single job. Application is not required to map a polygon.

Using Data -> Job data -> Manage or with Fieldware Link, a user can duplicate and edit jobs for reuse of polygons for different applications over the same field.

To establish a polygon:

1. Drive to a desired location at the perimeter of the area and orientate the vehicle in association to the established mapping location. See "Configuration-> Mapping and guidance-> Mapping location" for details.
2. Press BOUNDARY AND POLYGON OPTIONS tab  to display boundary and polygon options.
3. Press MARK POLYGON icon .
4. Verify that the Mapping location is correct.
 - ◀ If the Mapping location is not correct, press **Cancel** then go to Configuration-> Mapping and Guidance-> Mapping Location.
5. Travel the perimeter of the area.

While traveling, use as needed:





 - ▶ Pause Polygon  – pauses the mark polygon process.
 - ▶ Resume Polygon  – resumes the mark polygon process.
 - ▶ Cancel Polygon  – cancels mark polygon process.
6. Press FINISH POLYGON icon  to finalize current mark polygon process. A straight line will complete the polygon between your current location and the starting point.
7. Press:
 - ▶ Save and name – to save the polygon with a customized name. Names previously established will be available from a drop down list .
 - ▶ Save without naming – to save the polygon without naming
 - ▶ Discard – to delete the polygon

Figure 1-30: Polygon



Delete Last Marked Polygon

Use DELETE POLYGON icon  to delete the last marked polygon from the current job. Press again to remove additional polygons in order from last to first created.

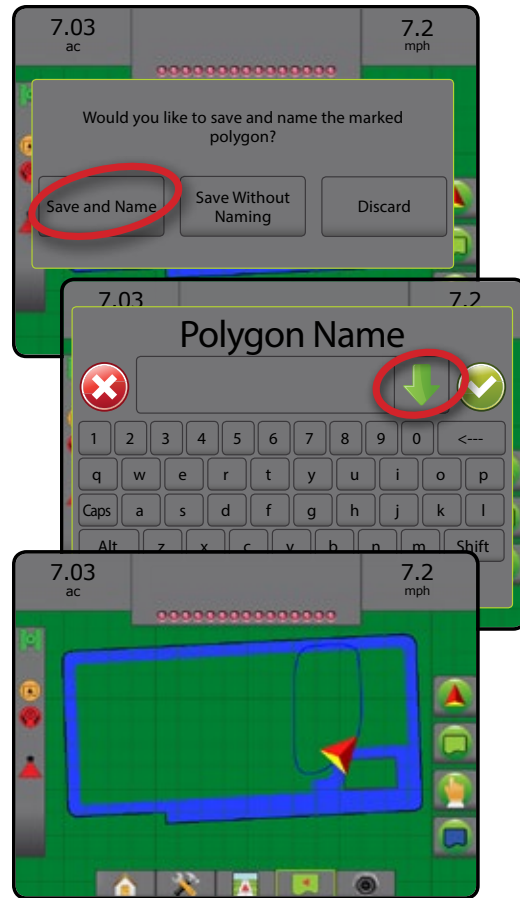
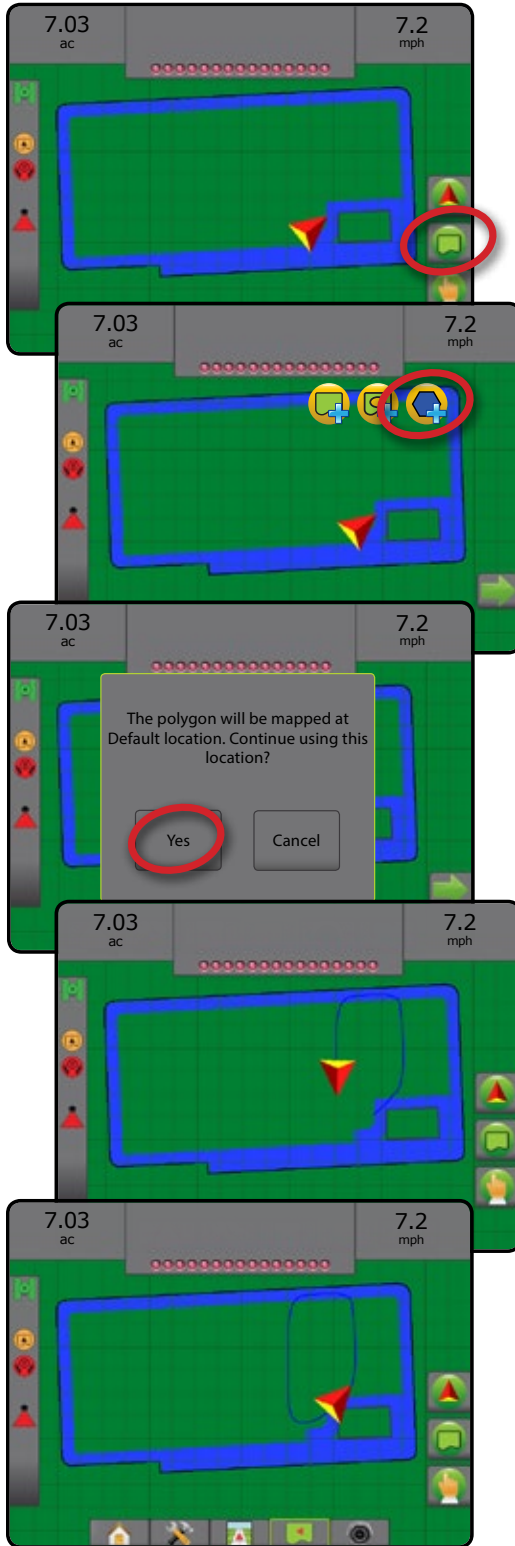
Figure 1-31: Delete Last Marked Polygon





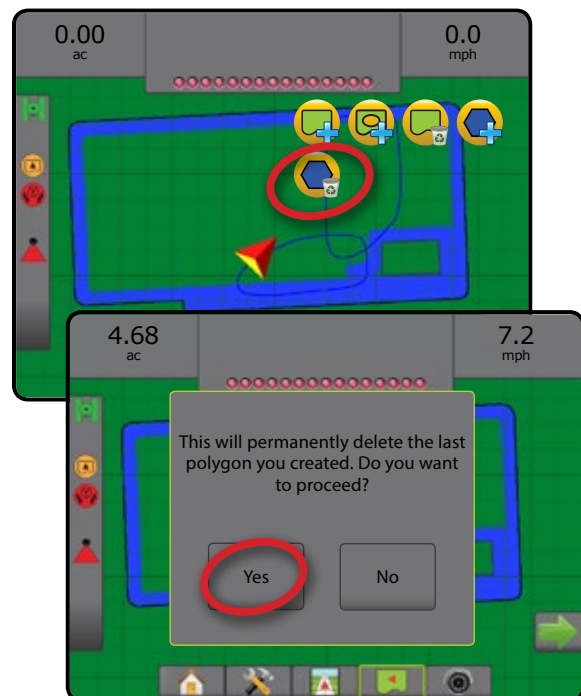

MAPPING OPTIONS

On vehicle view or field view guidance screens, in any guidance mode, the mapping options tab displays options to display polygon maps, coverage maps and application maps.

Polygon and coverage mapping are available when a polygon has been established.

GNSS-based product application mapping is available when a rate controller is on the system. Rate control mapping can record areas covered by the implement (Coverage) or how much product has been applied and where (Application), and can direct single- and variable-rate product application (Preset Target rate and Prescription, respectively).

- Coverage Map  – shows areas covered by the implement, regardless of whether product was applied
- Polygons  – shows all mapped polygons
- Prescription Map  – pre-loaded map that provides information to the rate controller for use in applying product
- Application Map  – shows how much product has been applied and where, using color to indicate level in proportion to preset or automatically set maximum and minimum levels
- Target Rate Map  – shows the application rate that the rate controller attempted to achieve at each location

NOTE: Before using mapping, set or verify product mapping options under Configuration->Product. Refer to “Product” in the System setup chapter. For more information on application mapping, see the Rate control chapter of this manual.

Polygon Mapping

To access polygon mapping:









1. Press MAPPING OPTIONS tab  to display mapping options.
2. Select one or more:
 - ▶ Coverage map 
 - ▶ Polygons 

Figure 1-32: Coverage map with polygons

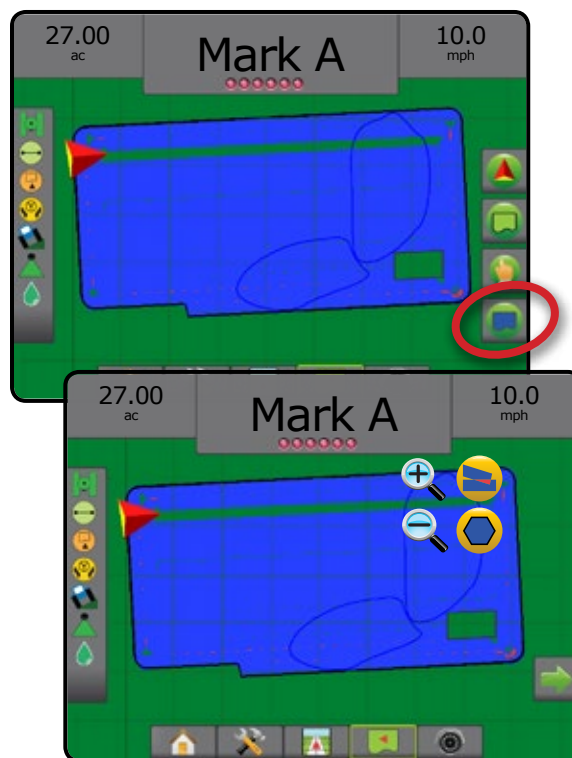

Rate Control Mapping

To access rate control mapping:

1. Press MAPPING OPTIONS tab  to display mapping options.
2. Select one or more:
 - ▶ Coverage Map 
 - ▶ Prescription Map 
 - ▶ Application Map 
 - ▶ Target rate Map 

NOTE: Application Map and Target Rate Map cannot be selected simultaneously.

Figure 1-33: Coverage Map with Rate Control Mapping

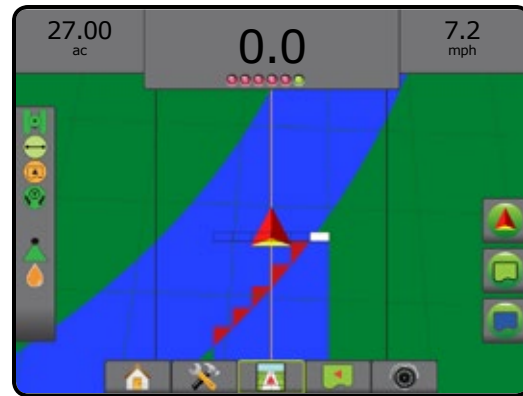
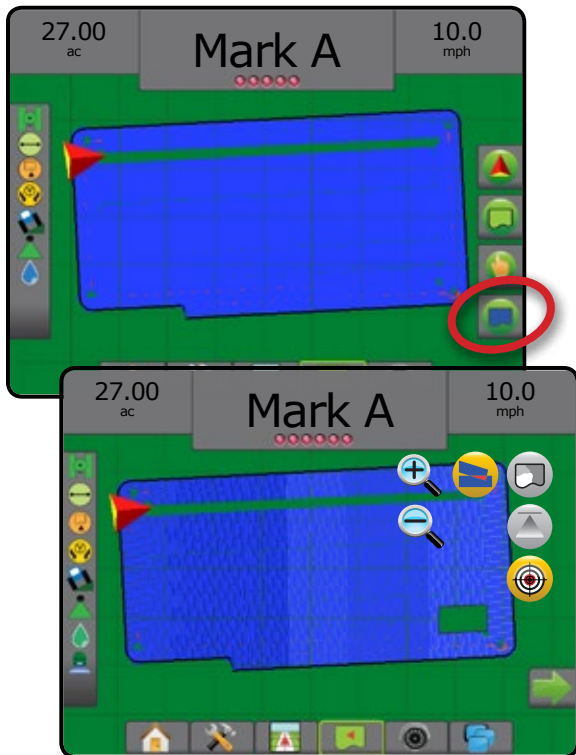

Field View

Zoom in/out is used to adjust the map's visible area.

- Zoom In will decrease the amount of map area visible.
- Zoom Out will increase the amount of map area visible.

PAN MODE

While in Field view guidance, the Pan mode allows the screen to be positioned manually as desired. The off-centre position on the screen will be retained until the World icon is pressed.

To enter Pan mode and pan across the screen:

1. Press SCREEN OPTIONS tab .
2. Press:
 - ▶ AND DRAG SCREEN in the corresponding direction to move the view on screen.
 - ▶ ARROWS in the corresponding direction to move the view on screen (down, left, right, up).
 - ▶ WORLD VIEW icon to centre vehicle on screen and extend the screen view to the widest area available.

NOTE: Press & Hold ARROWS to quickly adjust settings.

To close Pan Mode options:

1. Press CLOSE OPTIONS tab .

Figure 1-35: Pan Mode

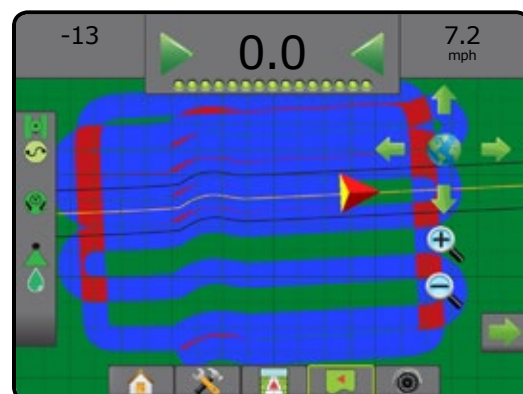

ZOOM IN/OUT

Vehicle View

Zoom In/Out & Perspective is used to adjust the vehicle's view or perspective to the horizon from vehicle view to bird's-eye view.

- Zoom In will adjust view to vehicle view displaying a compass on the horizon
- Zoom Out will adjust view to bird's-eye view

Figure 1-34: Zoom In to Zoom Out

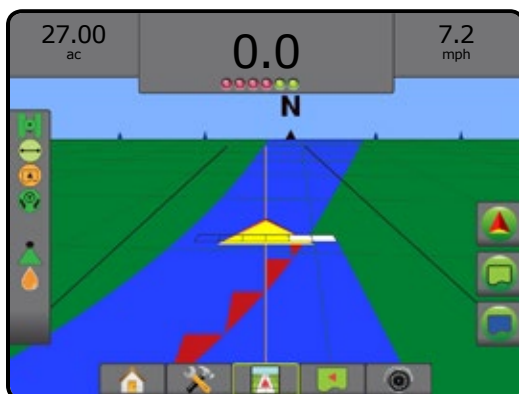

REALVIEW SPECIFIC OPTIONS

RealView guidance allows live video input to be displayed instead of a computer-generated image. RealView setup options accesses additional guidance tools including guidance over video and a steering angle indicator.

- ▶ Single Camera – a single camera is directly attached to the console
- ▶ Video Selection Module – if a Video selection module (VSM) is installed on the system, two (2) video options are available:
 - One Camera View – one of up to eight camera inputs can be selected to change the view of the video input.
 - Split Camera View – one of two sets of four camera inputs (A/B/C/D or E/F/G/H) can be selected to divide the screen into four separate video feeds.

To adjust the camera view [reverse, upside down], go to Setup-> Configuration-> Video.

To access the RealView options:

1. Press REALVIEW GUIDANCE bottom tab .
2. Press REALVIEW OPTIONS tab  to display RealView options.
3. Select from:
 - ▶ Single Camera View  [VSM only] – one (1) of up to eight (8) camera inputs can be selected to change the view of the video input
 - ▶ Split Camera View  [VSM only] – one (1) of two (2) sets of four (4) camera inputs (A/B/C/D or E/F/G/H) can be selected to divide the screen into four separate video feeds
 - ▶ RealView Guidance Options  – accesses additional guidance tools including guidance over video and a steering angle indicator
 - ▶ RealView Camera Image Capture  – saves a still photo of the current view on the screen to a USB drive

Figure 1-36: RealView Guidance



RealView Guidance Options

 RealView setup options accesses additional guidance tools including guidance over video and a steering angle indicator.







1. Press REALVIEW OPTIONS tab  to display RealView options.
2. Press REALVIEW GUIDANCE OPTIONS icon .
3. Select from:
 - ▶ Guidance Over Video  – places three-dimensional guidelines over the video feed for navigation assistance
 - ▶ Steering Angle Indicator  – displays the direction in which the steering wheel needs to be adjusted
 - ▶ Horizon Line Adjustment  ▲ ▼ – adjusts the on-screen horizon line up or down

Figure 1-37: RealView Setup Options

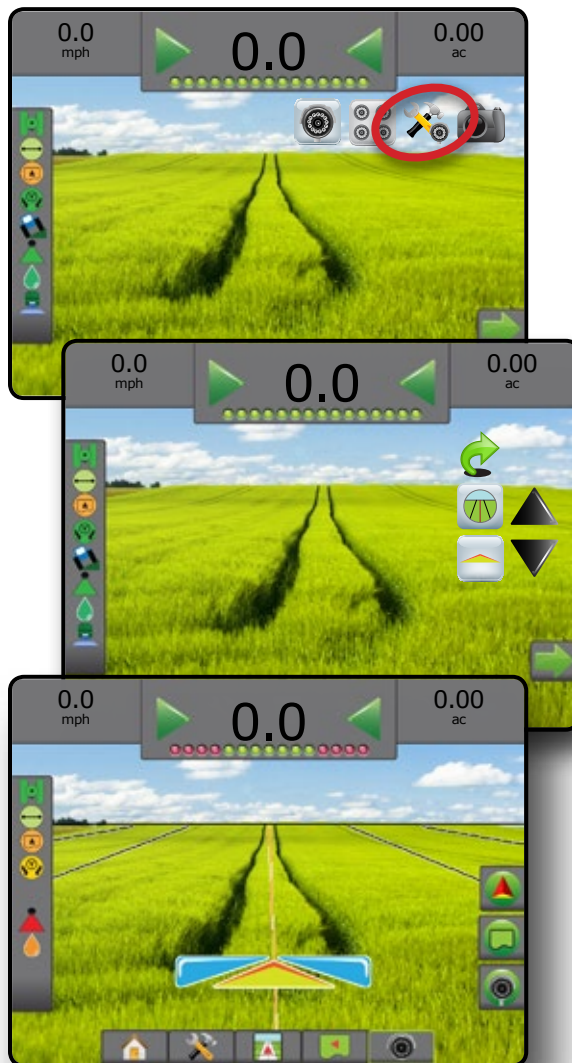

Camera Snapshot

 RealView Camera Snapshot saves a still photo of the current view on the screen to a USB drive.





1. Insert USB drive.
2. Press REALVIEW OPTIONS tab  to display RealView options.
3. Press CAMERA SNAPSHOT icon .

Figure 1-38: RealView Camera Snapshot



VSM Camera Options

  If a Video Selection Module (VSM) is installed on the system, two (2) video options are available:



1. Press REALVIEW OPTIONS tab  to display RealView options.
2. Select from:
 - ▶ Single Camera View  – one (1) of up to eight (8) camera inputs can be selected to change the view of the video input
 - ▶ Split Camera View  – one (1) of two (2) sets of four (4) camera inputs (A/B/C/D or E/F/G/H) can be selected to divide the screen into four separate video feeds

Figure 1-39: Single Camera Selection with VSM



Figure 1-40: Select Split View with VSM



CHAPTER 1 – THIRD-PARTY RATE CONTROL

When a Third-Party Rate Control system is present and Rate Control has been unlocked, application information and mapping can be shown on the guidance screens.

To add a third-party rate controller to the system:

1. Add a rate controller to the system.
2. Power on the rate controller.
3. On the Matrix Pro GS console, unlock Third-Party Rate Control.
4. Restart the Matrix Pro GS.
5. On the Matrix Pro GS console, configure Third-Party Rate Control settings – used to configure hardware interface and communication.
6. On the Matrix Pro GS console, configure Product settings – used to configure product name, tank/bin volumes, target application rates, increment for adjusting target rates, and color mapping maximum/minimum rate limits and corresponding display colors

THIRD-PARTY RATE CONTROL UNLOCK

Feature Unlock is used to unlock advanced features.

NOTE: The unlock code is unique for each console. Contact TeeJet Technologies Customer Service. Once unlocked, a feature remains unlocked unless the console is fully reset.



1. Press CONSOLE side tab .
2. Press **Feature Unlock**.
3. Press the locked feature button  for Third-Party Rate Control.
4. Enter unlock code.
5. Restart the console.



Figure 1-1: Feature Unlock



SETUP OPTIONS

Third-Party Rate Control

When a Third-Party Rate Control system is present and Rate Control has been unlocked, a Third-Party Rate Control can be enabled/disabled.

1. Press SYSTEM SETUP bottom tab .
2. Press CONFIGURATION side tab .
3. Press **Third-Party Rate Control**.
4. Select if Third-Party Rate Control is enabled or disabled.
5. When disabled, select from:
 - ▶ Hardware Interface – used to select an interface for communication with a third-party rate controller.
 - ▶ Communication Protocol – used to select a protocol for communication with a third-party rate controller.
 - ▶ Controller Mode – If an applicable protocol is selected, used to select the controller mode that matches rate controller's configuration.
 - ▶ Serial Baud Rate – if using a serial interface device, used to select the appropriate communication baud rate.

At any time, select:

- ▶ Rate Control Status – used to view the status of a connected third-party rate controller.

Figure 1-2: Third-Party Rate Control



Product

When a Third-Party Rate Control system is present and Rate Control has been unlocked, Product options are available for configuring product control channel names and maximum/minimum rate limits and corresponding display colors for mapping.



1. Press SYSTEM SETUP bottom tab .
2. Press CONFIGURATION side tab .
3. Press **Product**.
4. Select from:
 - ▶ Product Name – used to enter the name of the product for the current Control Channel
 - ▶ Maximum/Minimum Rate Color – used to create the color scheme that best represents the change in rates across an application or target rate map
 - ▶ Color Range – used to select Automatic or Manual mode for setting Maximum and Minimum Rate Color
 - ▶ Applied Rate Mapping Upper Limit [Manual Color Range only] – used to set the maximum rate for which the Maximum Rate Color will be used (higher rates will use the selected Maximum Rate Color)
 - ▶ Applied Rate Mapping Lower Limit [Manual Color Range only] – used to set the minimum rate for which the Minimum Rate Color will be used (lower rates will use the selected Minimum Rate Color)

Figure 1-3: Product Options



GUIDANCE SCREEN OPTIONS

When a Third-Party Rate Controller is integrated into the system, additional rate control and mapping options are available on the Vehicle View and Field View guidance screens.

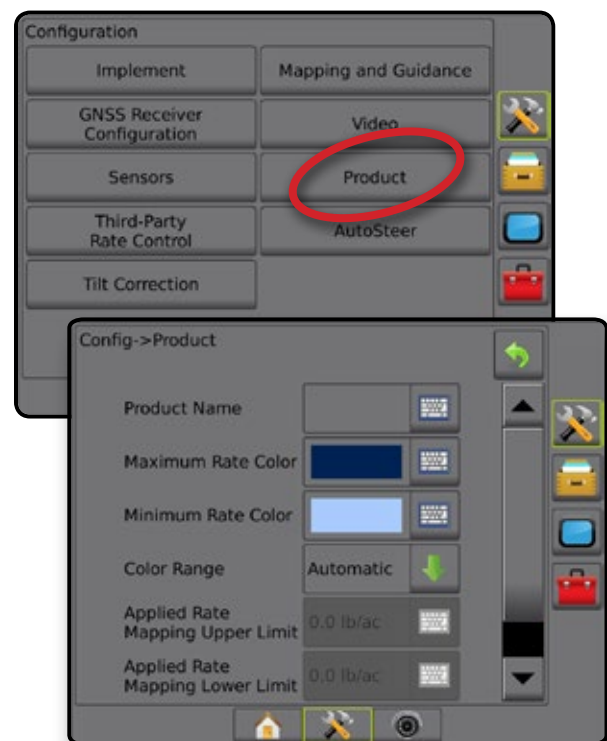
On Screen Guidance

In addition to the standard Guidance options, the following information will become available with Third-Party Rate Control:

- Guidelines
 - ◀ Black/White – prescription map zone boundary line
- Coverage Area – illustrates applied area and overlap:
 - ◀ User Selected – Application Map and Target Rate Map applied areas show colored bars relative to selected color range and map selection.

Guidance Bar

In addition to the standard Guidance bar options, the following selectable information will become available with Third-Party Rate Control:

- ▶ Actual Application Rate – displays the current application rate
- ▶ Target Application Rate – displays the target application rate

Figure 1-4: Guidance Bar Selectable Information

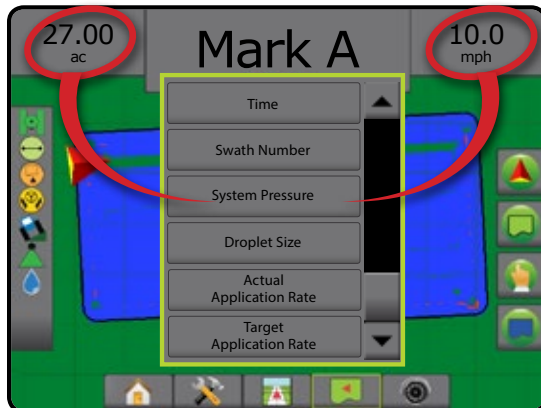

Status Bar

In addition to the standard Status Bar bar options, the Product Rate Control Status icon provides information on rate control status.

When an icon is pressed, the related status information is displayed.

1. Press PRODUCT RATE CONTROL STATUS icon .

Figure 1-5: Product Rate Control Status



Rate Control Status

- Green = normal operation
- Yellow = system warning (incorrect rate/pressure, etc.)
- Red = system error (incorrect rate/pressure, etc.)
- No Icon = no rate control installed

MAPPING OPTIONS

On vehicle view or field view guidance screens, in any guidance mode, the mapping options tab displays options to display polygon maps, coverage maps and application maps.

Polygon and coverage mapping are available when a polygon has been established.

GNSS-based product application mapping is available when a rate controller is on the system. Rate control mapping can record areas covered by the implement (Coverage) or how much product has been applied and where (Application), and can direct single- and variable-rate product application (Preset Target rate and Prescription, respectively).









NOTE: Before using mapping, set or verify product mapping options under Configuration->Product. Refer to "Product" in the System setup chapter.

Duplicating and Transferring Maps

Maps are stored in the job data. Using Data-> Job data, job data containing maps can be duplicated or transferred to Fieldware Link so the maps can be opened, viewed, edited, and printed, and transferred back to the console. See "Data management->Job data->Transfer" and "Data management-> Job data-> Manage" in the System setup chapter for details.

Using Data-> Reports, reports in multiple formats can be generated that contain data and any maps from the job.

To access Application mapping:

1. Press VEHICLE VIEW GUIDANCE bottom tab  or FIELD VIEW GUIDANCE bottom tab .
2. Press MAPPING OPTIONS tab  to display mapping options.
3. Select one or more:
 - ▶ Coverage map  – shows areas covered by the implement, regardless of whether product was applied
 - ▶ Polygons  – shows all mapped polygons
 - ▶ Prescription map  – pre-loaded map that provides information to the rate controller for use in applying product
 - ▶ Application map  – shows how much product has been applied and where, using color to indicate level in proportion to preset or automatically set maximum and minimum levels
 - ▶ Target rate map  – shows the application rate that the rate controller attempted to achieve at each location

NOTE: Application map and Target rate map cannot be selected simultaneously.

Figure 1-6: Coverage, Polygon and Target Rate Maps

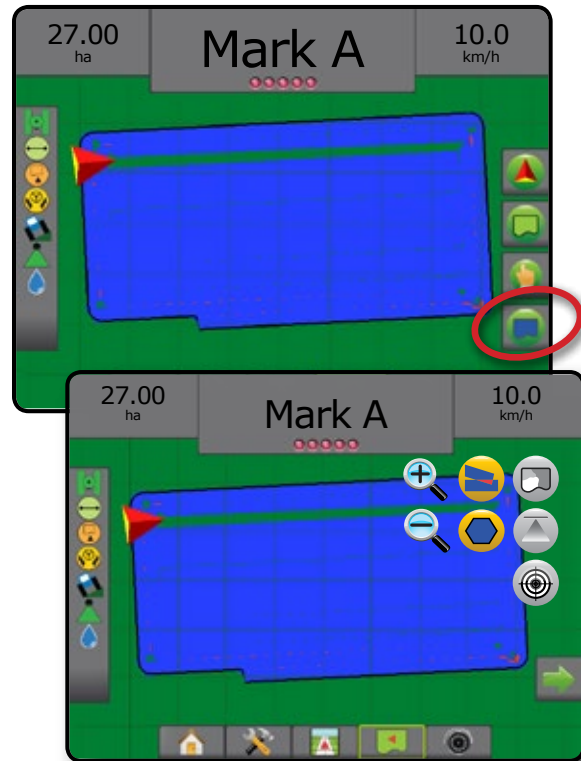

Coverage Map

 Coverage map showing areas covered by the implement.

On Screen Mapping

- Coverage Area – illustrates applied area and overlap:
 - ◀ Blue – one application
 - ◀ Red – two or more applications

Figure 1-7: Coverage map



Polygons Map

 Polygon map shows all mapped polygons.

On Screen Mapping

- Guidelines
 - ◀ Blue – polygon boundary line

Figure 1-8: Polygon Map with Rate Control Available

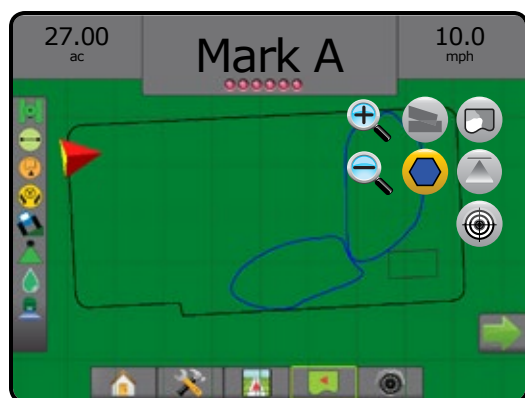

Prescription Map

 Prescription map is a pre-loaded map that provides information to the rate controller for use in applying product. Prescription maps contain geo-referenced product rate information. The Matrix Pro GS can import job data containing Prescription maps for use with variable-rate application (VRA) using compatible rate controllers.

On Screen Mapping

- Zone lines:
 - ◀ Black when approaching the application zone.
 - ◀ White when within the application zone.
 - ◀ Other zones having the same rate will also be shown in white.
- Coverage Area – illustrates different prescription rate zones:
 - ◀ User selected – zone colors are selected when establishing the Prescription map.

With Fieldware Link (v5.01 or later), users can import VRA jobs created in Fieldware Link, as well as export job data from the console, edit the included maps to create Target rate or Prescription maps, and transfer back to the console for job use.

NOTE: Advanced job mode is required for variable rate applications. See Options (Job mode) in the System setup chapter.

Figure 1-9: Prescription map



Application and Target Rate Maps

Application Map  shows how much product has been applied and where, using color to indicate level in proportion to preset or automatically set maximum and minimum levels

Target Rate Map  shows the application rate that the rate controller attempted to achieve at each location

NOTE: Application map and Target Rate map cannot be selected simultaneously.

Application Map

 Application Map shows how much product has been applied and where, using color to indicate level in proportion to preset or automatically set maximum and minimum levels.

NOTE: Application Map and Target Rate Map cannot be selected simultaneously.

On Screen Mapping

- Coverage Area – illustrates applied area:
 - ◀ User Selected – applied areas show colored bars relative to selected color range and map selection.

Figure 1-10: Application Map



Target Rate Map

 Target Rate Map shows the target application rate that the rate controller attempted to achieve at each location.

NOTE: Application Map and Target Rate Map cannot be selected simultaneously.

On Screen Mapping

- Coverage Area – illustrates applied area:
 - ◀ User Selected – applied areas show colored bars relative to selected color range and map selection.

Figure 1-11: Target Rate Map

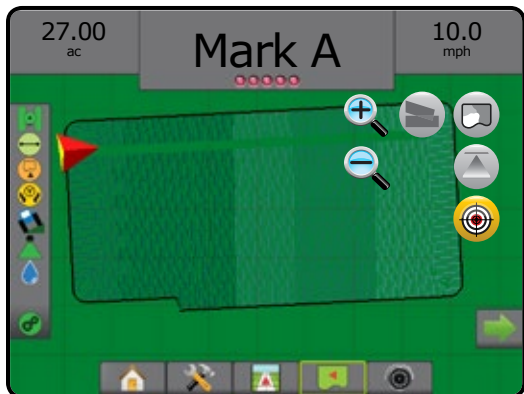

Target Rates

Preset Target Application Rates define target rates of product being applied per hectare/acre. These settings will set the same for all active jobs.

Color Range Selection

Product options configure maximum/minimum rate limits and corresponding display colors for mapping.

1. Press CONFIGURATION side tab .
2. Press **Product**.
3. Select:
 - ▶ Color Range – mode used to set the rate for Maximum Rate Color and Minimum Rate Color.
 - ◀ Automatic – maximum and minimum will be determined by actual applied rate values or target rate values
 - ◀ Manual – maximum and minimum limits will be set to those set in Applied Rate Mapping Upper Limit and Applied Rate Mapping Lower Limit options
 - ▶ Maximum Rate Color – used to set the color for the maximum rate. When in Manual Color Range mode, this color will be used for all rates above the Applied Rate Mapping Upper Limit
 - ▶ Minimum Rate Color – used to set the color for the minimum rate. When in Manual Color Range mode, this color will be used for all rates below the Applied Rate Mapping Lower Limit

Figure 1-12: Product Options



APPENDIX A – SYSTEM CONFIGURATIONS

The following diagrams are reflective of typical Matrix Pro GS configurations. Due to the variety of possible configurations, this should be used for reference purposes only.

Figure A-1: Matrix Pro GS with FieldPilot AutoSteering System

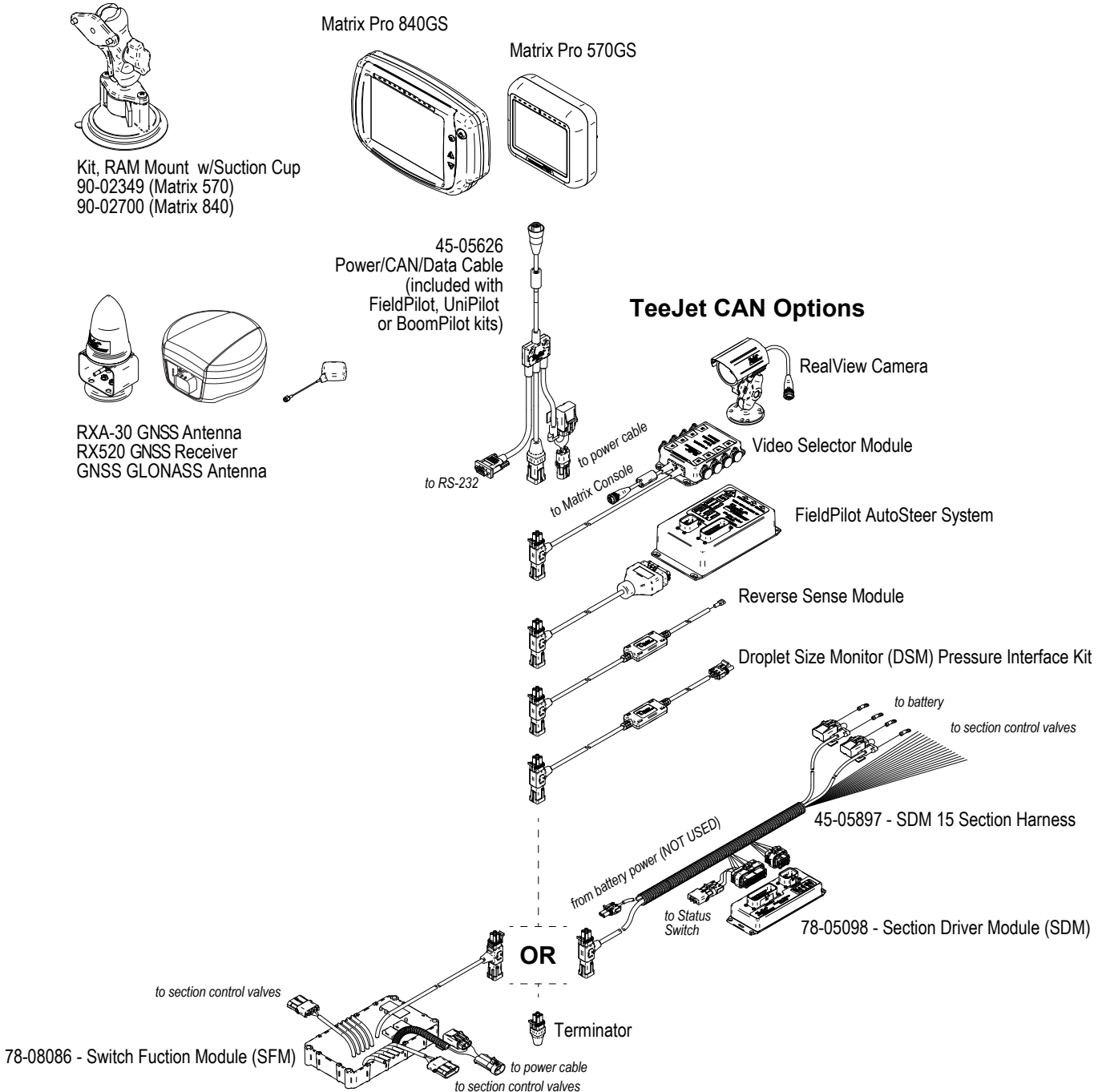

MATRIX® Pro 570GS • MATRIX® Pro 840GS

Figure A-2: Matrix Pro GS with FieldPilot Pro or UniPilot Pro Steering System

INTRODUCTION

HOME

FULL SCREEN

SETUP

GNSS

IMPLEMENT

GUIDANCE

RATE CONTROL

APPENDIX

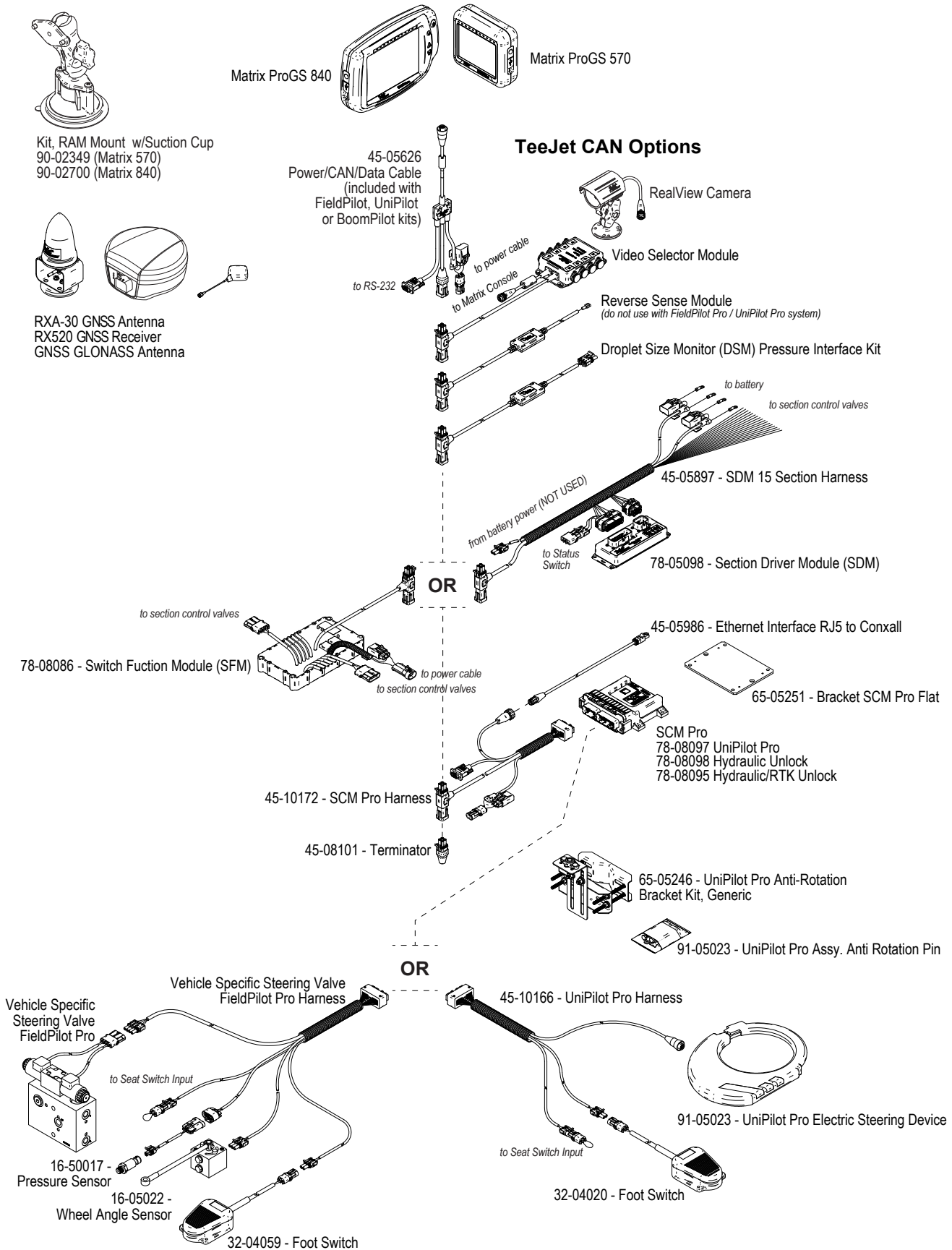

APPENDIX B – MATRIX PRO GS CONSOLE MENU SETTINGS

This appendix lists the Matrix Pro GS console's menu settings, and also provides the following:

- Settings available with an active job.
- Settings that can be made in the Matrix Pro GS console itself, or using the Fieldware Link software.
- Settings that are included when exported to a profile from the Matrix Pro GS console, or from Fieldware Link.

Symbol Key

In the following tables, these symbols indicate whether settings are available during an active job:

- ✓ Available during an active job
- ✗ Not Available during an active job
- ◀ Retained from console with profile
- ▶ Retained from Fieldware Link with profile

Configuration Settings

Configuration Settings		Available with Active Job	Can be edited in		Saved to exported profile in	
			Matrix Pro	Fieldware Link	Matrix Pro	Fieldware Link
	Machine Type	✗	✓	✗	✓	◀
	GNSS Antenna Height.....	✗	✓	✓	✓	✓
	Implement Type	✗	✓	✓	✓	✓
	Symmetric Implement Layout.....	✗	✓	✓	✓	✓
	Number of Implement Sections	✗	✓	✓	✓	✓
	Application/Working Width.....	✗	✓	✓	✓	✓
	Droplet Size Monitor	✓	✓	✗	✓	◀
	Tip Selection					
	Current Tip.....	✗	✓	✗	✓	◀
	Tip Preset	✗	✓	✗	✓	◀
	Applied Alert	✓	✓	✗	✓	◀
	Entry Time	✓	✓	✗	✓	◀
	Exit Time.....	✓	✓	✗	✓	◀
	Allow BoomPilot In Reverse	✓	✓	✗	✓	◀
	BoomPilot Start Mode.....	✓	✓	✗	✓	◀
	BoomPilot Icon	✓	✓	✗	✓	◀
	Reverse Signal Delay.....	✓	✓	✗	✓	◀
Implement	Implement In-Line Offset Direction	✗	✓	✓	✓	✓
	Implement In-Line Offset Distance	✗	✓	✓	✓	✓
	Straight Mode					
	Implement Lateral Offset Direction	✗	✓	✓	✓	✓
	Implement Lateral Offset Distance	✗	✓	✓	✓	✓
	Overlap.....	✓	✓	✓	✓	✓
	Delay On/Off Times	✓	✓	✓	✓	✓
	Setup Type: TeeJet	✗	✓	✓	✓	✓
	Antenna to Disks In-line Offset Distance	✗	✓	✓	✓	✓
	Implement Lateral Offset Direction	✗	✓	✓	✓	✓
	Implement Lateral Offset Distance	✗	✓	✓	✓	✓
	Overlap.....	✓	✓	✓	✓	✓
Delay On/Off Times	✓	✓	✓	✓	✓	
Spreader Mode	Spread Offset Distance	✗	✓	✓	✓	✓
	Section Offsets	✗	✓	✓	✓	✓
	Section Lengths.....	✗	✓	✓	✓	✓
	Setup Type: OEM	✗	✓	✓	✓	✓
	Antenna to Disks In-line Offset Distance	✗	✓	✓	✓	✓
	Implement Lateral Offset Direction	✗	✓	✓	✓	✓
	Implement Lateral Offset Distance	✗	✓	✓	✓	✓
Start/Stop Distances.....	✗	✓	✓	✓	✓	
Section Start/Stop Offsets	✗	✓	✓	✓	✓	

Continued...

MATRIX® Pro 570GS • MATRIX® Pro 840GS

INTRODUCTION
 HOME
 FULL SCREEN
 SETUP
 GNSS
 IMPLEMENT
 GUIDANCE
 RATE CONTROL
 APPENDIX

 Configuration Settings		Available with Active Job	Can be edited in		Saved to exported profile in		
			Matrix Pro	Fieldware Link	Matrix Pro	Fieldware Link	
Implement (continued)	Staggered Mode	Section 1 In-Line Offset Direction	x	✓	✓	✓	✓
		Section 1 In-Line Offset Distance	x	✓	✓	✓	✓
		Implement Lateral Offset Direction	x	✓	✓	✓	✓
		Implement Lateral Offset Distance	x	✓	✓	✓	✓
		Overlap	✓	✓	✓	✓	✓
		Delay On/Off Times	✓	✓	✓	✓	✓
		Section Offsets	x	✓	✓	✓	✓
Guidance and Mapping	Mapping location	✓	✓	x	✓	◀	
	Location name	✓	✓	x	✓	▶	
	Mapping location in-line offset direction	✓	✓	x	✓	▶	
	Mapping location in-line offset distance	✓	✓	x	✓	▶	
	Mapping location lateral offset direction	✓	✓	x	✓	▶	
	Mapping location lateral offset distance	✓	✓	x	✓	▶	
	Guidance Width	x	✓	✓	✓	✓	
	LED Brightness	✓	✓	x	x	x	
	Display Mode	✓	✓	x	x	x	
	LED Spacing	✓	✓	x	x	x	
	External Lightbar	✓	✓	x	x	x	
	External Lightbar LED Brightness	✓	✓	x	x	x	
	External Lightbar Text Brightness	✓	✓	x	x	x	
	External Cross Track	✓	✓	x	x	x	
	External Swath Number	✓	✓	x	x	x	
	External Speed	✓	✓	x	x	x	
	External Actual Rate	✓	✓	x	x	x	
	External Target Rate	✓	✓	x	x	x	
	External Applied Product	✓	✓	x	x	x	
GNSS Receiver Configuration	GNSS Type	x	✓	x	x	x	
	GNSS Port	x	✓	x	x	x	
	GNSS Status Information	✓	✓	x	x	x	
	Program	x	✓	x	x	x	
	PRN	x	✓	x	x	x	
Show Refresh GNSS Position Button	✓	✓	x	x	x		
Video	Reverse/Inverse	✓	✓	x	x	x	
Sensors	IOM Pressure Sensor	Maximum Pressure Rating	✓	✓	✓	✓	
		Low Pressure Alarm	✓	✓	✓	✓	
		High Pressure Alarm	✓	✓	✓	✓	
Product*	Product Name	x	✓	✓	✓	✓	
	Tip Constant	x	x	✓	▶	✓	
	Maximum Rate Color	✓	✓	x	✓	▶	
	Minimum Rate Color	✓	✓	x	✓	▶	
	Color Range	✓	✓	x	✓	▶	
Applied Rate Mapping Upper /Lower Limits	x	✓	x	✓	▶		
Third-Party Rate Control*	Enable/Disable	x	✓	x	x	x	
	Hardware Interface	x	✓	x	x	x	
	Communication Protocol	x	✓	x	x	x	
	Controller Mode	x	✓	x	x	x	
	Serial Baud Rate	x	✓	x	x	x	
Rate Controller Status	✓	✓	x	x	x		

Continued...

Configuration Settings			Available with Active Job	Can be edited in		Saved to exported profile in	
				Matrix Pro	Fieldware Link	Matrix Pro	Fieldware Link
AutoSteer with FieldPilot Pro or UniPilot Pro	Manage Vehicles	New	x	✓	x	x	x
		Load.....	x	✓	x	x	x
		Edit	x	✓	x	x	x
		Copy	x	✓	x	x	x
		Auto Calibration	x	✓	x	x	x
		Adjust.....	✓	✓	x	x	x
	Adjust	Delete	x	✓	x	x	x
		Manual Disengage.....	x	✓	x	x	x
		Motor Aggressiveness	✓	✓	x	x	x
		UniPilot Pro Freeplay.....	✓	✓	x	x	x
		Steering Response.....	✓	✓	x	x	x
		Heading Aggressiveness	✓	✓	x	x	x
		Cross Track Error	✓	✓	x	x	x
		Line Acquisition.....	✓	✓	x	x	x
AutoSteer (continued)	Reverse Response.....	✓	✓	x	x	x	
	Tilt Calibration.....	x	✓	x	x	x	
	Wheel Angle Sensor (WAS) Calibration	x	✓	x	x	x	
	Select QI Values	✓	✓	x	x	x	
	Maximum DOP	✓	✓	x	x	x	
AutoSteer	Transport Mode	✓	✓	x	x	x	
	Service Mode.....	✓	✓	x	x	x	
	Operator Presence	✓	✓	x	x	x	
	Assisted/Auto Steering Enabled/Disabled	✓	✓	x	✓	◀	
	Valve Setup	Valve Type	x	✓	x	✓	◀
		Valve Frequency.....	x	✓	x	✓	◀
		Minimum Left/Right Duty Cycle	x	✓	x	✓	◀
		Maximum Left/Right Duty Cycle	x	✓	x	✓	◀
	Steering Settings	Coarse Steering Adjustment.....	✓	✓	x	✓	◀
		Fine Steering Adjustment	✓	✓	x	✓	◀
		Deadband	✓	✓	x	✓	◀
	Options	Lookahead.....	✓	✓	x	✓	◀
Valve Test		x	✓	x	✓	◀	
Steering Angle Sensor	Valve Diagnostics	x	✓	x	✓	◀	
	Steering Wheel Sensor.....	x	✓	x	✓	◀	
	Enabled/Disabled	x	✓	x	✓	◀	
Tilt Correction	Sensor Calibration.....	✓	✓	x	✓	◀	
	On Line Calibration.....	✓	✓	x	✓	◀	
Enabled/Disabled	x	✓	x	✓	◀		
Field Level	x	✓	x	✓	◀		

*Available only with an active Third-Party Rate Controller on the system.

Data Management Settings

Data Management Settings		Available with Active Job	
Job Data	Export	x	
	Transfer Import	x	
	Delete	x	
	Manage	New	x
		Copy	x
		Delete	x
Reports	Save PDF	x	
	Save KML	x	
	Save SHP	x	
	Save all types	x	
Options	Job Mode	x	
Machine Settings	Export	✓	
	Transfer Import	✓	
	Delete	✓	
	Manage	New	✓
		Copy	✓
		Delete	✓
	Save	✓	
	Load	x	

Console Settings

Console Settings		Available with Active Job
About	System Information	✓
	Save	✓
Display	Color Scheme	✓
	LCD Brightness	✓
	Screenshot	✓
	Screen Calibration	✓
Cultural	Units	✓
	Language	✓
	Time Zone	✓
Audio Volume	Audio Volume	✓
Demo GNSS	Start	✓
Feature Unlock	BoomPilot for Spreader	✓
	Third-Party Rate Control	✓
	FieldPilot Pro / UniPilot Pro	✓

Tools Settings

Tools Settings		Available with Active Job
Upload Software	Device	x
	Software	x
Extras	Calculator	✓
	Units Converter	✓

APPENDIX C – UNIT SPECIFICATIONS

Dimensions	Matrix Pro 570GS	16.15 x 14.91 x 5.84 cm
	Matrix Pro 840GS	27.0 x 18.0 x 6.0 cm
Weight	Matrix Pro 570GS	0.794 kg
	Matrix Pro 840GS	1.06 kg
Connector	Power/CAN	8 pin Conxall
	Camera	5 pin Conxall
	Speed/Status	8 pin Conxall
<i>WARNING! Some original Matrix consoles have a 4 pin conxall cable connection. The 4-pin and 8-pin cables are NOT interchangeable.</i>		
Environmental	Storage	+14°F to +158°F / -10°C to +70°C
	Operating	+32°F to +122°F / 0°C to +50°C
	Humidity	90% non-condensing
Display	Matrix Pro 570GS	320 x 240 resolution, 5.7 in / 14.5 cm
	Matrix Pro 840GS	800 x 600 resolution, 8.4 in / 21.3 cm
Input/output		USB 2.0
Power requirement		< 9 watts @ 12 VDC

APPENDIX D – SETTING RANGES

Press the option's name of any menu item to display a definition and range values of that item.

Figure A-3: Example of Information Text Box



APPENDIX E – UTM COORDINATES AND ZONES

The Matrix Pro 570GS and Matrix Pro 840GS use the Universal Transverse Mercator (UTM) coordinate system to track job locations. The UTM coordinate system divides the surface of the Earth into sixty numbered north-south zones, which are further divided into latitude zones designated by letters, as shown below.

Figure A-4: UTM Coordinate System – Global

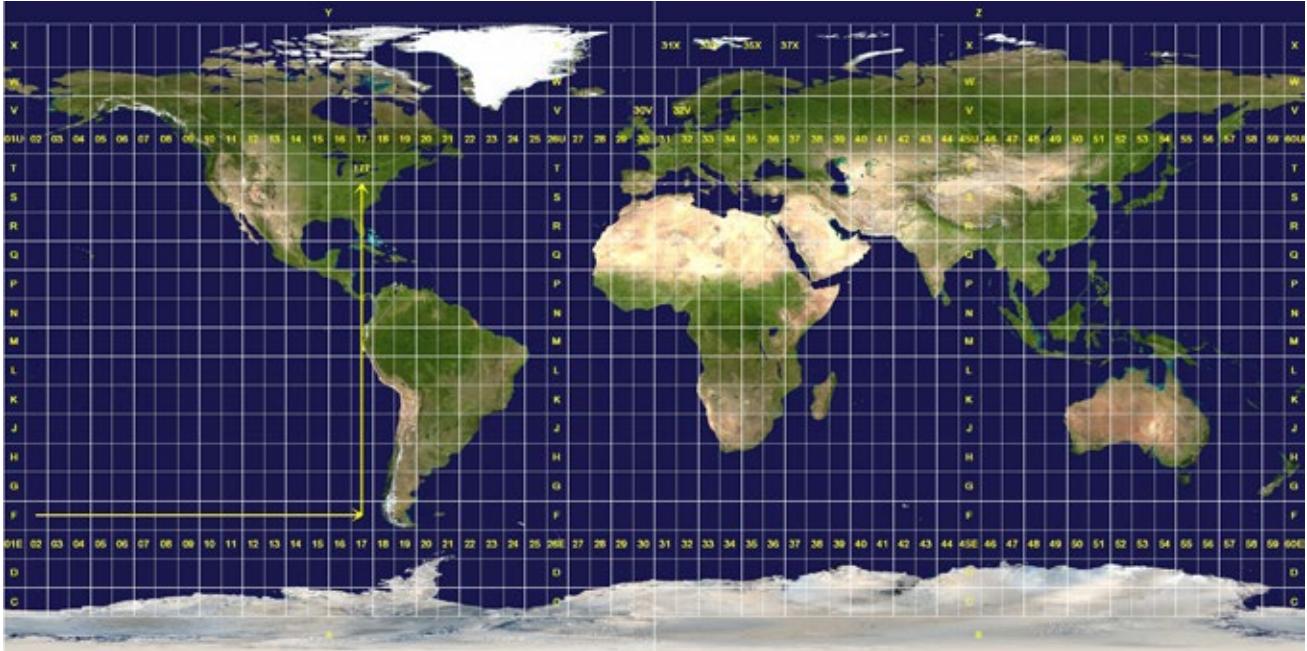

The Matrix Pro GS console then tracks the UTM zones in which each product application job is performed. This zone information is then used to determine whether a job can be started/continued or to find the saved job that is closest to the vehicle's current position.

If a selected job is in a UTM zone other than the current or adjacent UTM zone, "Out of Range" will be displayed next to Distance, and **Start Job** or **Continue** will be disabled.

If a selected job has no recorded information, Distance will show "No Data".

Copyrights

© 2017 TeeJet Technologies. All rights reserved. No part of this document or the computer programs described in it may be reproduced, copied, photocopied, translated, or reduced in any form or by any means, electronic or machine readable, recording or otherwise, without prior written consent from TeeJet Technologies.

Trademarks

Unless otherwise noted, all other brand or product names are trademarks or registered trademarks of their respective companies or organizations.

Limitation of Liability

TEEJET TECHNOLOGIES PROVIDES THIS MATERIAL "AS IS" WITHOUT WARRANTY OF ANY KIND, EITHER EXPRESSED OR IMPLIED. NO COPYRIGHT LIABILITY OR PATENT IS ASSUMED. IN NO EVENT SHALL TEEJET TECHNOLOGIES BE LIABLE FOR ANY LOSS OF BUSINESS, LOSS OF PROFIT, LOSS OF USE OR DATA, INTERRUPTION OF BUSINESS, OR FOR INDIRECT, SPECIAL, INCIDENTAL, OR CONSEQUENTIAL DAMAGES OF ANY KIND, EVEN IF TEEJET TECHNOLOGIES HAS BEEN ADVISED OF SUCH DAMAGES ARISING FROM TEEJET TECHNOLOGIES SOFTWARE.



Safety Information

TeeJet Technologies is not responsible for damage or physical harm caused by failure to adhere to the following safety requirements.

As the operator of the vehicle, you are responsible for its safe operation.

The Matrix Pro GS in combination with any assisted/auto steering device is not designed to replace the vehicle's operator.

Do not leave a vehicle while the Matrix Pro GS is engaged.

Be sure that the area around the vehicle is clear of people and obstacles before and during engagement.

The Matrix Pro GS is designed to support and improve efficiency while working in the field. The driver has full responsibility for the quality and work related results.

Disengage or remove any assisted/auto steering device before operating on public roads.

MATRIX® PRO GS

U S E R M A N U A L

Product Upgrades Available

- FieldPilot® auto steering
- UniPilot® assisted steering
- BoomPilot® automated section control
- Tilt gyro module
- Video selection modules for up to 8 cameras
- External GNSS receiver or antenna upgrades
- Fieldware® Link enhanced data organization application
- Pressure sensor kit for droplet size monitor
- Third-Party Rate Control



A Subsidiary of  *Spraying Systems Co.*

www.teejet.com