

RADION 8140

USER MANUAL

Automatic Sprayer Control
Software version 1.07



TeeJet[®]
TECHNOLOGIES

A Subsidiary of  Spraying Systems Co.[®]

Copyrights

© 2018 TeeJet Technologies. All rights reserved. No part of this document or the computer programs described in it may be reproduced, copied, photocopied, translated, or reduced in any form or by any means, electronic or machine readable, recording or otherwise, without prior written consent from TeeJet Technologies.

Trademarks

Unless otherwise noted, all other brand or product names are trademarks or registered trademarks of their respective companies or organizations.

Limitation of liability

TEEJET TECHNOLOGIES PROVIDES THIS MATERIAL "AS IS" WITHOUT WARRANTY OF ANY KIND, EITHER EXPRESSED OR IMPLIED. NO COPYRIGHT LIABILITY OR PATENT IS ASSUMED. IN NO EVENT SHALL TEEJET TECHNOLOGIES BE LIABLE FOR ANY LOSS OF BUSINESS, LOSS OF PROFIT, LOSS OF USE OR DATA, INTERRUPTION OF BUSINESS, OR FOR INDIRECT, SPECIAL, INCIDENTAL, OR CONSEQUENTIAL DAMAGES OF ANY KIND, EVEN IF TEEJET TECHNOLOGIES HAS BEEN ADVISED OF SUCH DAMAGES ARISING FROM TEEJET TECHNOLOGIES SOFTWARE.



Safety information

TeeJet Technologies is not responsible for damage or physical harm caused by failure to adhere to the following safety requirements. As the operator of the vehicle, you are responsible for its safe operation. The Radion 8140 in combination with any assisted/auto steering device is not designed to replace the vehicle's operator. Do not leave a vehicle while the Radion 8140 is engaged. Ensure the area around the vehicle is clear of people and obstacles before and during engagement. The Radion 8140 is designed to support and improve efficiency while working in the field. The driver has full responsibility for the quality and work related results. Disengage or remove any assisted/auto steering device before operating on public roads.

Table of contents

CHAPTER 1 – INTRODUCTION	1
Product upgrades available	1
SYSTEM COMPONENTS	1
Radion 8140 console	1
Additional information	1
BASIC SCREEN USE	2
Home screen	2
Options tab	3
Console screen colours	3
Options menus	4
Next page	4
Keyboard entry screen	4
Warnings and information pop-ups	4
Setup option information	4
CHAPTER 2 – OPERATION	6
Operation menu	6
Information bar	7
REGULATION MODES	7
Manual regulation mode	8
INFORMATION BAR	8
Selectable information	8
Selecting a job number	9
Application rate	9
Select target application rate	9
Change preset target application rate	10
Target rate percentage increase/decrease	10
Change application rate step	11
NOZZLE SELECTION	11
Selecting the current nozzle	11
Presetting nozzles	11
TANK	12
ALARM WARNING	13
PRESSURE GAUGE	13
BOOM SECTIONS & SWITCHES	14
CHAPTER 3 – SETTINGS	15
JOB PARAMETERS	16
Establish preset target application rates	16
MACHINE	17
Filling	18

Radion 8140 automatic sprayer control

INTRODUCTION

OPERATION

SETTINGS

DATA

CONSOLE

TOOLS

APPENDIX

Operation	20
Implement parameters.....	21
Section configuration.....	21
Establish number of nozzles.....	22
Nozzle preset setup	22
Establish nozzle presets.....	23
Regulation parameters	24
Calibrations.....	25
Implement speed sensor	26
Implement speed sensor automatic calibration	26
Flow sensor.....	26
Flow sensor automatic calibration	27
Liquid pressure sensor	27
Maximum pressure automatic calibration.....	28
Maximum pressure manual calibration.....	29
Fill flow sensor	29
Fill flow sensor automatic calibration	29
Tank level sensor	30
Alarms.....	33
Active alarms on Operation screen	33

OEM 34

Sensor presence.....	35
Implement parameters.....	36
Sections on Operation screen	37
Valve setup.....	37
Tank setup	38
Regulation details.....	39
Clear totals	40
Import/export data.....	41

DIAGNOSTICS 42

Test inputs	43
Test outputs.....	44
Verify section valve state.....	44
Test BoomPilot.....	45
Alarm log	46
Save alarm log.....	46

SETTINGS MENU OPTIONS 47

CHAPTER 4 – DATA 49

Jobs.....	49
Job data report.....	50
Campaign	50
Clear all campaign counters	50
Totals	51
CSV report	51

CHAPTER 5 – CONSOLE 52

Display	52
Cultural.....	53
Language selection	53
Sound.....	54
Unlock.....	54
About	54

CHAPTER 6 – TOOLS 55

Radion 8140 automatic sprayer control

APPENDIX A – SYSTEM CONFIGURATIONS AND CONNECTIONS	56
CONFIGURATIONS	56
CONNECTIONS	56
Radion console connections	56
Miscellaneous connections	57
APPENDIX B – USER SETTING NOTES	58
APPENDIX C – ALARM CONFIGURATIONS	60
APPENDIX D – UNIT SPECIFICATIONS	61

INTRODUCTION

OPERATION

SETTINGS

DATA

CONSOLE

TOOLS

APPENDIX

Radion 8140 automatic sprayer control

INTRODUCTION

OPERATION

SETTINGS

DATA

CONSOLE

TOOLS

APPENDIX

IMPORTANT SAFETY INFORMATION

All safety related and operating instructions should be read before the system is operated. Safe operation of machinery is the operators responsibility. Safety procedures must be posted close to the equipment and clearly visible to and legible by the operator. Safety procedures should meet all company and local regulations, as well as MSDS-requirements. For assistance, contact a local dealer.

Safety Alert Symbol Definitions:



DANGER! This symbol is reserved for the most extreme situations where serious personal injury or death is imminent.



WARNING! This symbol indicates a hazardous situation that could result in serious personal injury or death.



CAUTION! This symbol indicates a hazardous situation that could result in minor or moderate personal injury.



NOTE: This symbol addresses practices in which the operator should be aware.

GENERAL WARNINGS AND PRECAUTIONS



DANGER!

- Read and follow instructions. If instructions are unclear after reading the manual, please contact a local dealer.
- Keep children away from equipment.
- Do not operate machinery under the influence of alcohol or any illegal substance.
- Some systems include a fan heater. Never cover the heater otherwise there will be a serious danger of fire!



WARNING! ELECTRICAL / SHOCK HAZARDS

- Before working on any particular component, make sure that all power supplies have been switched off and cannot be accidentally switched on.
- Disconnect power leads before using an arc welder on equipment or anything connected to the equipment.
- Systems including frequency drives have a risk of electric shock due to residual voltage. It is not permissible to open the equipment neither to disconnect the system or any quick connection until 5 minutes after the power has been removed.
- Only operate the system from the power source indicated in the manual. If you are not sure of the power source, consult qualified service personnel.
- Do not use a high pressure cleaner to clean electrical components. This could damage electrical components and subject the operator to risk of electrical shock.
- The electrical supply to the equipment must be properly routed and connected to the equipment. All connections must meet the specified requirements.



WARNING! PRESSURIZED HYDRAULIC SYSTEMS

- Always wear personal protective equipment (PPE) when performing work on hydraulic systems.
- Adhere to the machine manufacture's approved maintenance instructions when working on the hydraulic system.
- Always turn equipment off when working on the hydraulic system. Take appropriate precautions when opening systems that have been previously pressurized.
- Be aware that hydraulic oil may be extremely hot and under high pressure.



WARNING! CHEMICAL HANDLING

- Always wear PPE when handling any chemical substance.
- Always follow safety labels and instructions provided by the chemical manufacturer or supplier.
- The operator should have full information on the nature and the quantity of the material to be distributed.
- **ADHERE TO FEDERAL, STATE AND LOCAL REGULATIONS REGARDING THE HANDLING, USE OR DISPOSAL OF AGRICULTURAL CHEMICALS.**



WARNING! PRESSURIZED SPRAY SYSTEM

- It is important to recognize proper safety precautions when using a pressurized spray system. Fluids under pressure can penetrate skin and cause serious personal injury.
- The system pressure should never exceed the lowest rated component. Always know your system and all component capabilities, maximum pressures and flow rates.
- Filters can only be opened when the manual valves in front of and behind the filter are in closed position. If any appliance has to be taken out of the piping, manual valves in front of and behind this appliance have to be in closed position. If they are reinstalled, make sure that this happens correctly, that this apparatus is well aligned, and that all connections are tight.
- The plumbing supply to the equipment should meet all company and local regulations and must be properly routed and connected to the equipment. All connections must meet the specified requirements
- It is advised to drain and purge the liquid train when the equipment shall not be used for a longer period of time.



WARNING! AUTO STEERING SAFETY

- To prevent serious personal injury or death from being run over by the vehicle or automated motion of the steering system, never leave the vehicles operator seat with the system engaged.
- To prevent serious personal injury or death from being run over by the vehicle or automated motion of the steering system, verify the area around the vehicle is clear of people or obstacles before startup, calibration, tuning or engaging the system.
- Make sure equipment is tightly secured to the proper components.
- Never drive on public roads with system engaged.



CAUTION! EQUIPMENT SAFETY, MAINTENANCE, AND SERVICE

- The equipment should be operated only by properly trained, qualified personnel. They must have proven their skills in the operation of the equipment.
- Before using the equipment, the operator has to check if the equipment is in good condition and can be used safely. If not, the equipment cannot be used.
- All necessary PPE must be readily available to the operator at all times.
- Routinely check the system and components for wear and damage. Replace or repair when necessary.
- Only qualified authorized experts are allowed to repair or maintain the installation. The maintenance and operating instructions shall be rigidly observed and followed.
- A complete manual for the equipment must be available to the operator or maintenance technician at all times.



CAUTION! HARNESS CABLE AND HOSE SAFETY

- Routinely check all harness cables and hoses for damage or wear. Replace or repair when necessary.
- Do not route harness cables and hoses with sharp bends.
- Do not strap harness cables and hoses to lines with high vibration or spikes in pressure.
- Do not strap harness cables and hoses to lines transporting hot fluids.
- Protect harness cables and hoses from sharp objects, equipment debris, and material buildup.
- Allow sufficient length for harness cables and hoses to have free movement on sections that move during operation, and be sure that harness cables or hoses do not hang below the equipment.
- Allow sufficient clearance for harness cables and hoses from implement and machine operational zones.
- When cleaning equipment, protect harness cables from high pressure wash.



NOTE: TOUCH SCREEN CARE

- Keep sharp objects away from the touch screen device. Touching the screen with a sharp object could result in damage to the display.
- Do not use harsh chemicals to clean the console/display. The correct way to clean a console/display is to use a soft damp cloth or anti-static wipe, similar to cleaning a monitor on a computer.



NOTE: RECOMMENDED REPLACEMENT PARTS

- The system has been designed with components that work together to provide the best system performance. When the system requires replacement parts, only TeeJet recommended components should be use to maintain proper system operation and safety.
-

CHAPTER 1 – INTRODUCTION

Designed with simplicity in mind, Radion 8140 offers spraying advantages not found in other controllers. Setting the target application rate and the unique VisiFlo® display on the controller helps select the right TeeJet nozzle for the application. Once spraying begins, the large display shows application rate, volume sprayed, system pressure, sprayer speed, and area covered. Radion 8140's built-in planning tool automatically displays the available speed range for the target rate and spray nozzle that have been selected. Radion 8140 may be used as an individual controller or in combination with CAN bus technology using Matrix® Pro and BoomPilot® to add automated boom section control.

Product upgrades available

Matrix Pro guidance and BoomPilot automated boom section control.

SYSTEM COMPONENTS

Radion 8140 console

The Radion 8140 is designed to provide years of service under typical agricultural operating conditions. A tight fitting enclosure, combined with rubber covers for all connectors means that typical dusty environments will not cause operational problems. While occasional splashing of water will not damage the unit, the Radion 8140 is not designed for direct exposure to rain. Take care not to operate the Radion 8140 in wet conditions.

Figure 1-1: Radion 8140 console front and back



Additional information

All changes are saved automatically.

The console needs to be cycled off and back on when changing or attaching equipment to the Radion 8140 system.

Power on

Press the POWER button  to power on the console. Upon power up, a TeeJet screen appears while Radion 8140 initiates a start up sequence. Once start up is complete, the Operation screen appears.

Power off

Press the POWER button  until a pop-up screen appears. Press **Yes** to power off the console.

Simulated Speed Alert

An alert will sound at start-up if simulated speed is activated.

Radion 8140 automatic sprayer control

BASIC SCREEN USE

The basic screen functions are:

- Home button accesses the Home screen with setup buttons for Operation, Settings, Data, Console settings and Tools
- Options tab on the Operation screen accesses the Home button and application rate options
- Warnings and information pop-ups inform of console activities and details on setup or application functions
- Setup options can be applied using option menus or keyboard entry screens

NOTE: There is a Settings menu structure chart, at the end of the Chapter 1 – Overview.

When a job is active some setup options are unavailable.

Home screen

 The Home screen gives access to jobs, setup options and application control.

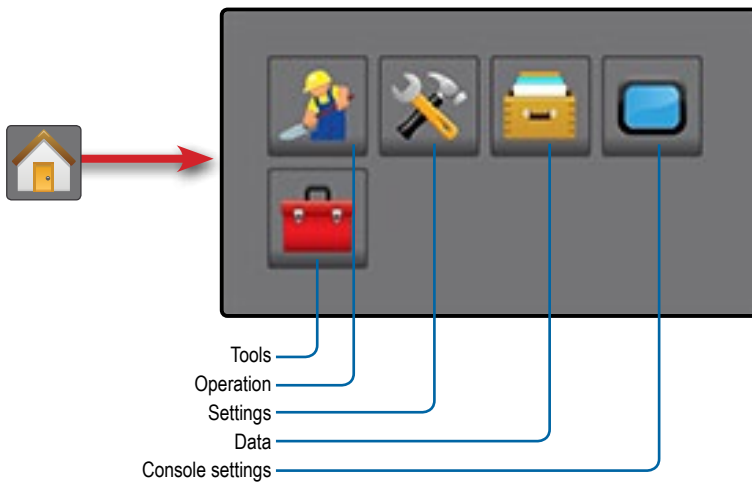
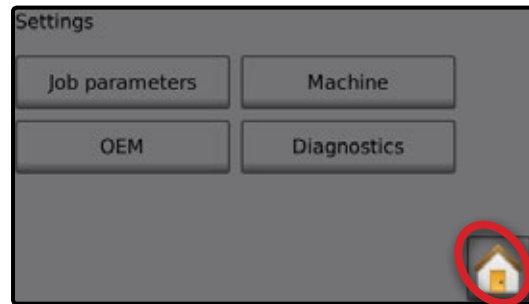

Figure 1-2: Home button from the Operation screen



Figure 1-3: Home button from a Settings screen



Options tab

The Options tab is always available on the Operation screen. This tab opens the Operation menu which accesses the Home button and regulation controls.

Operation menu settings buttons	
	Home
	Automatic/manual regulation mode
	Return to target rate
	Target rate percentage boost increase/decrease
	Regulation valve manual open/close
	Close menu

Figure 1-4: Options tab - Automatic regulation mode

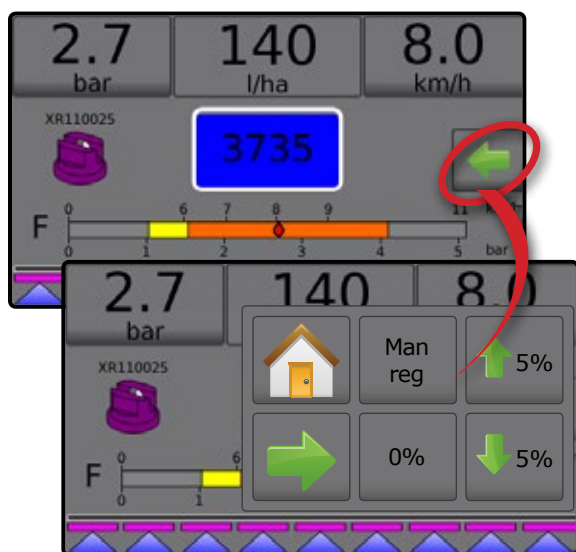
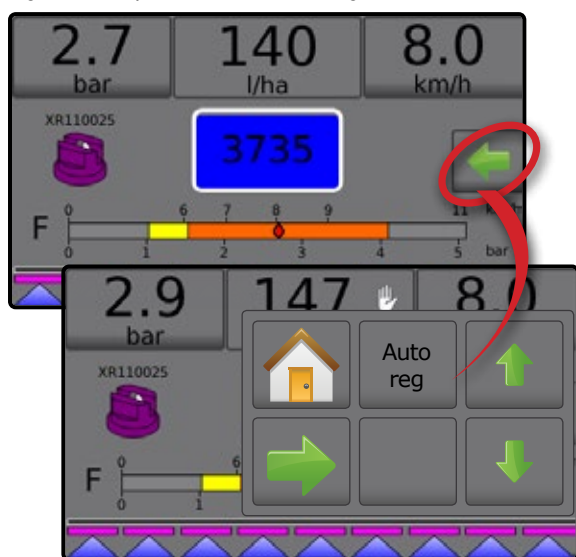

Figure 1-5: Options tab - Manual regulation mode



Console screen colours

The console is available in six (6) colour schemes. From the Home screen , press the CONSOLE button and choose **Display**. Press the current selection to access colour scheme options and select a colour style.

Figure 1-6: Colour schemes

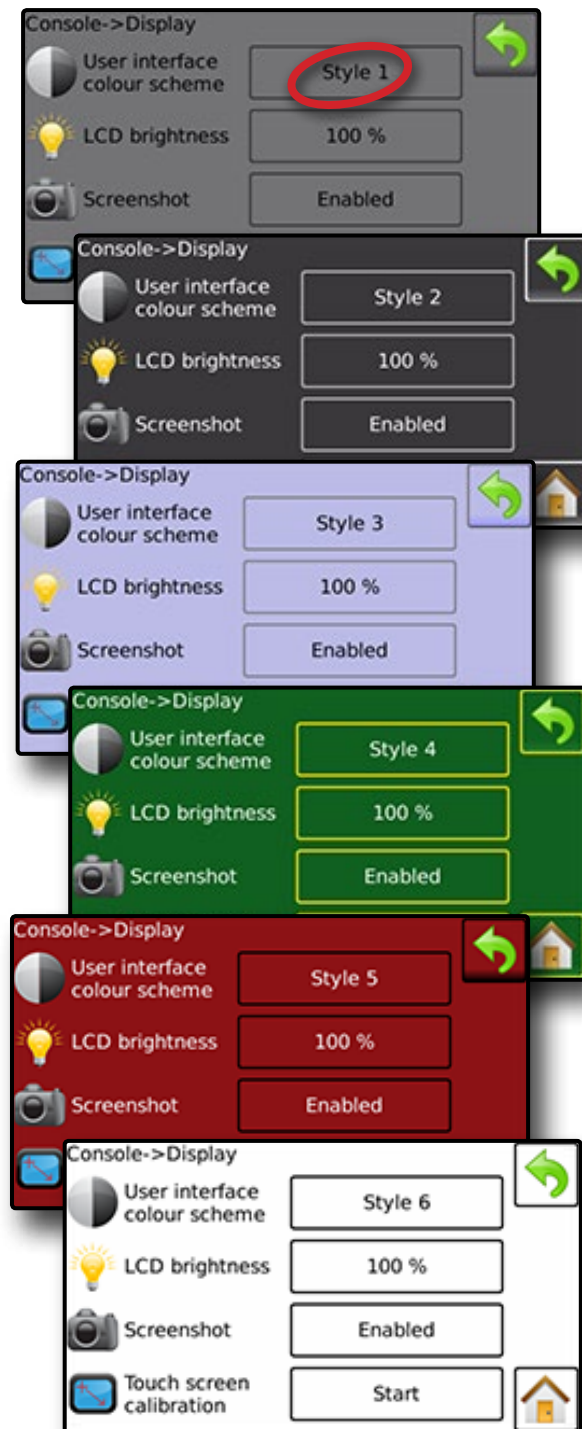

NOTE: When changing screen Styles, there is a slight delay in the screen displaying the new selection.

Radion 8140 automatic sprayer control

Options menus

Press the current selection to access options. Select an appropriate option, or use a next page arrow → to access additional options. To close the list without changing the current option, reselect the current option.

Figure 1-7: Example of option menu

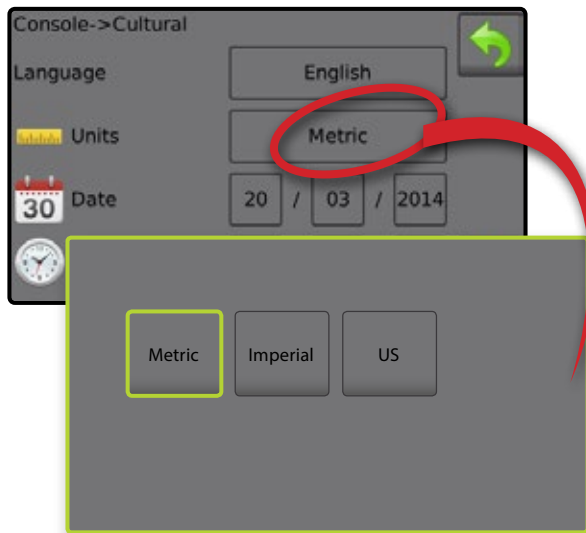

Next page

Some screens have more information/options that are visible beyond the current screen. Use the Next page arrow → to access additional options/information not currently visible on the screen.

Figure 1-8: Example of accessing additional options screen

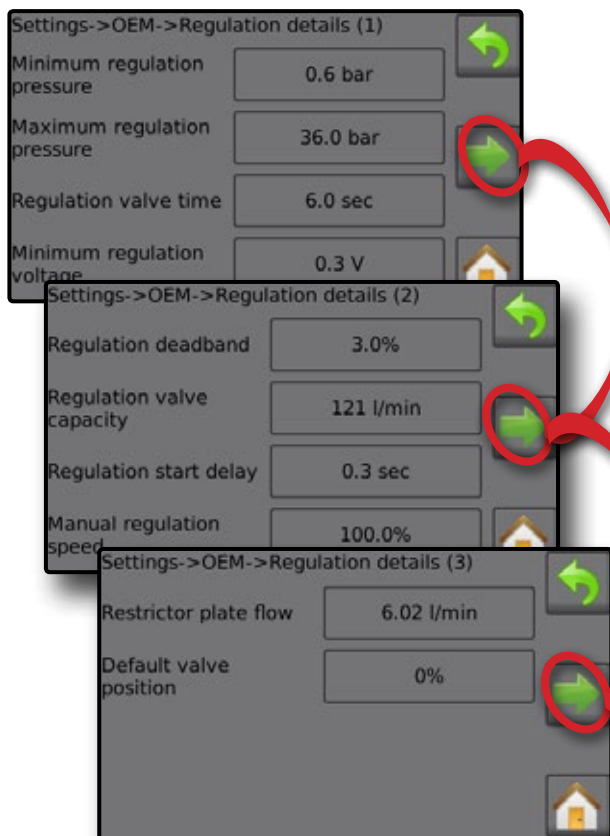

Keyboard entry screen

Some screens offer keyboard entry. Press the current selection to access the keyboard. Use the numeric keypad to enter a value.

Press the ACCEPT icon ✓ to save the settings or the CANCEL icon ✗ to leave the keypad without saving.

Figure 1-9: Example of keyboard

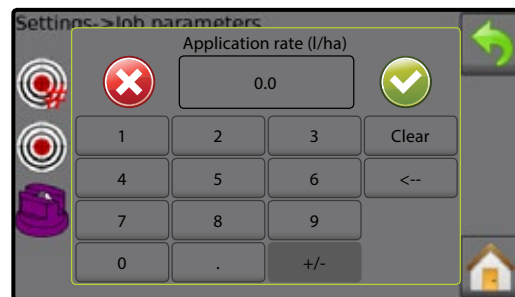

Warnings and information pop-ups

A pop-up warning or information box will display for approximately five (5) seconds. To remove the pop-up box, tap anywhere on the screen.

Figure 1-10: Information screens

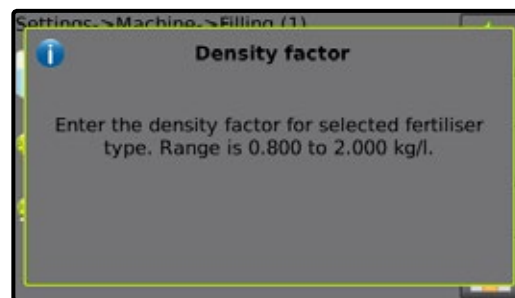

Setup option information

Press the option icon or option name, of any menu item, to display a pop-up information screen with a definition of and range values for that item. To remove the information box, press anywhere on the screen.

Figure 1-11: Example of information text box

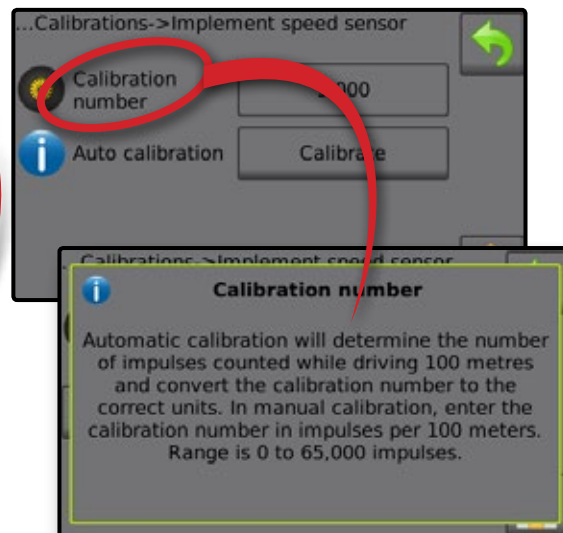

CHAPTER 1 – OPERATION





 Prior to operation, all settings and configurations must be established. Please contact a dealer or TeeJet Customer service representative with questions about system operations. TeeJet Technologies is not responsible for misuse or incorrect operation of the system. Settings are automatically saved when selected. Select functions may not be visible due to OEM settings, available equipment or sensors.

Figure 1-1: Operation screen overview

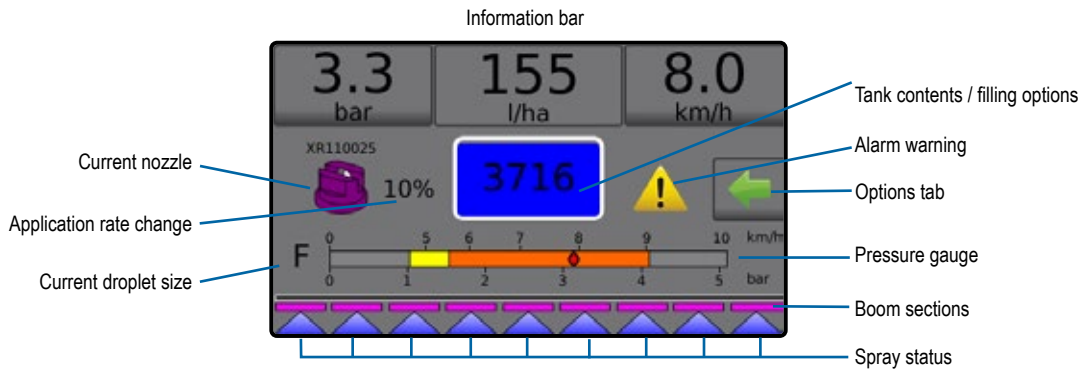

- From the Home screen, press the OPERATION button .
- Screen options include:
 - ▶ Information bar – displays application rates and selectable information
 - ▶ Current nozzle – displays current nozzle and accesses five (5) preset nozzle types
 - ▶ Application rate change – displays rate changes (if in Automatic regulation mode)
 - ▶ Tank – displays remaining tank contents and accesses filling options
 - ◀ Filling – establishes actual/desired tank material/density
 - ▶ Alarm warning – displays active alarm conditions
 - ▶ Options tab – accesses the Operation menu
 - ◀ Displays Home button, Close Menu button, regulation modes and target rate options

NOTE: Toggle between the Operation screen and Operation menu using the Options tab  and the Close menu button .
 - ▶ Pressure gauge – displays current pressure range compared with recommended pressure range
 - ◀ Droplet size – displays selected droplet size
 - ▶ Boom sections – displays configured boom sections
 - ◀ Spray status – displays active/inactive for section

Operation menu

The Options tab is always available on the Operation screen. This tab accesses the Operation menu where the Home button, regulation modes and target rate options display.

Operation menu buttons









	Home
 	Change between automatic/manual regulation modes
Automatic regulation mode	
	Target rate boost percent increase
	Target rate boost percent decrease
	Return to target rate
Manual regulation mode	
	Regulation valve manual open
	Regulation valve manual close
	Close menu

Figure 1-2: Options tab – Automatic mode

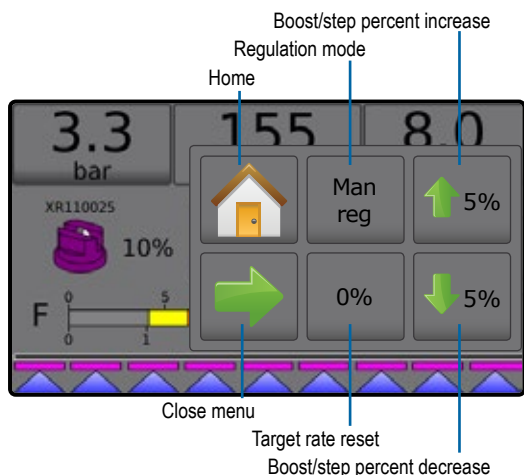
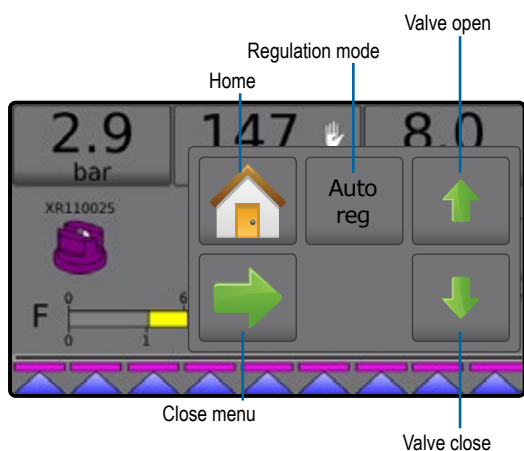

Figure 1-3: Options tab – Manual mode



Information bar

The information bar displays:

- ▶ Application rate – displays the actual application rate or target application rate and accesses the preset target application rates options menu.
- ▶ Selectable information – displays user-selected information including volume applied, flow rate, flow pressure, speed, total area applied and job number.

Figure 1-4: Information bar

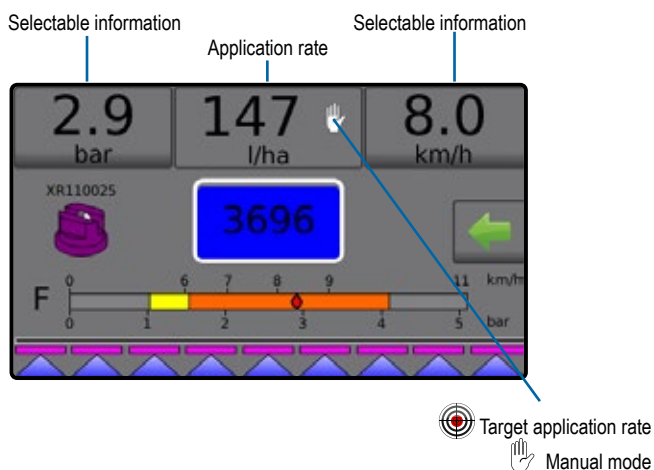

REGULATION MODES

Automatic regulation mode will automatically adjust the application rate based on the current speed in reference to the target rate. The target rate can be adjusted using the Boost/step percent increase/decrease buttons \uparrow 5% / \downarrow 5% on the Operation menu. Preset Application Rates define up to three (3) target rates for product being applied per hectare/acre. These can be toggled using the Application rate section on the Information bar on the Operation screen.

Manual regulation mode will retain an established regulation valve setting regardless of speed. The regulation valve setting can be adjusted using the Regulation valve open/close buttons \uparrow \downarrow on the Operation menu.

1. From the Operation screen, press the OPTIONS tab \leftarrow to display the Operation menu.

2. Select from:

- ▶ **Auto reg** to change from Manual regulation mode to Automatic regulation mode:
- ▶ **Man reg** to change from Automatic regulation mode to Manual regulation mode:

NOTE: The Regulation button displays the regulation mode that may be selected not the active regulation mode.

Figure 1-5: Regulation options: Automatic / Manual



Radion 8140 automatic sprayer control

Manual regulation mode

Manual regulation mode will retain an established regulation valve setting regardless of speed.

To open/close the valve:

1. From the Operation screen, press the OPTIONS tab ← to display the Operation menu.
2. Press the Regulation valve open/close buttons ↑ ↓ to manually turn the valves on/off.
3. Press the Close menu button →.

Figure 1-6: Manual regulation mode



INFORMATION BAR

The information bar displays user selected information and application rate information.

Figure 1-7: Information bar



Selectable information

Selectable information displays user-selected information.

1. Press either the left or right Selectable information section.
2. Select one (1) of six (6) available options to display for each side (options depend upon equipment in use).
 - ▶ Volume applied – displays volume applied for the current job number
 - ▶ Flow rate – displays current flow rate
 - ▶ Flow pressure – displays current flow pressure
 - ▶ Speed – displays vehicle speed
 - ▶ Area applied – displays applied area for the selected job number
 - ▶ Job number – displays the current job number

Figure 1-8: Selectable information



Figure 1-9: Selectable information options

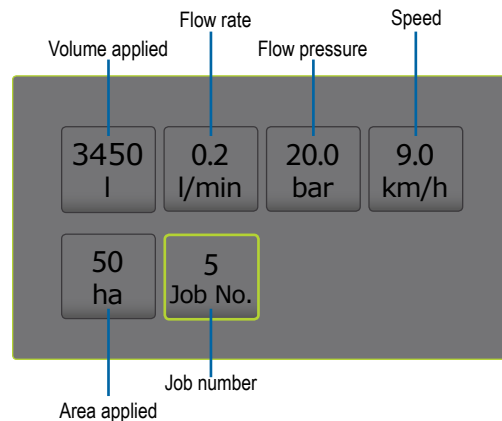

Selecting a job number

One of up to ten (10) jobs may be selected to view job information.









1. From the Operation screen, press the OPTIONS tab .
2. Press the HOME button .
3. From the Home screen, press the DATA button .
4. Press **Jobs**.
5. Press **Job number** to select current job number.
6. Press the HOME button .
7. From the Home screen, press the OPERATION button .

Figure 1-10: Selecting a job number



Application rate

Application rate displays or give access to:

- ▶ Application rate – while application is active, displays the actual application rate
- ▶ Target application rate – while application is inactive, displays the target rate of product to apply.
 - ◀ Automatic regulation mode – Target application rate symbol will be active 
 - Use the Boost/step percent increase/decrease buttons   to adjust the target application rate
 - ◀ Manual regulation mode – manual regulation symbol will remain active 
- ▶ Preset target application rates options menu – defines the target rate of product to apply for the selected number. These settings will be the same for all active jobs. Range is 0 to 6,554 litres/hectare.

Select target application rate

1. Press the Application rate section.
2. Select one (1) of up to three (3) preset application rates.

Figure 1-11: Select target application rate

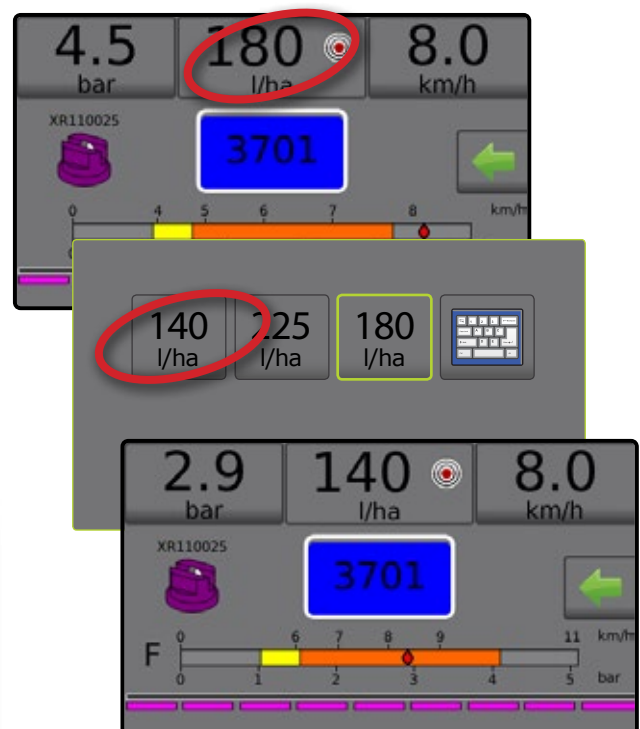

Radion 8140 automatic sprayer control

Change preset target application rate

The selected target rate can be changed either on the Operation screen or in Settings->Job parameters.

Operation

1. Press the Application rate section.
2. Select the target application rate to be changed.
3. Press KEYBOARD button .
4. Select an application rate.

NOTE: Value must be between 0 and 6,554 litres/hectare.

Figure 1-12: Application rate number

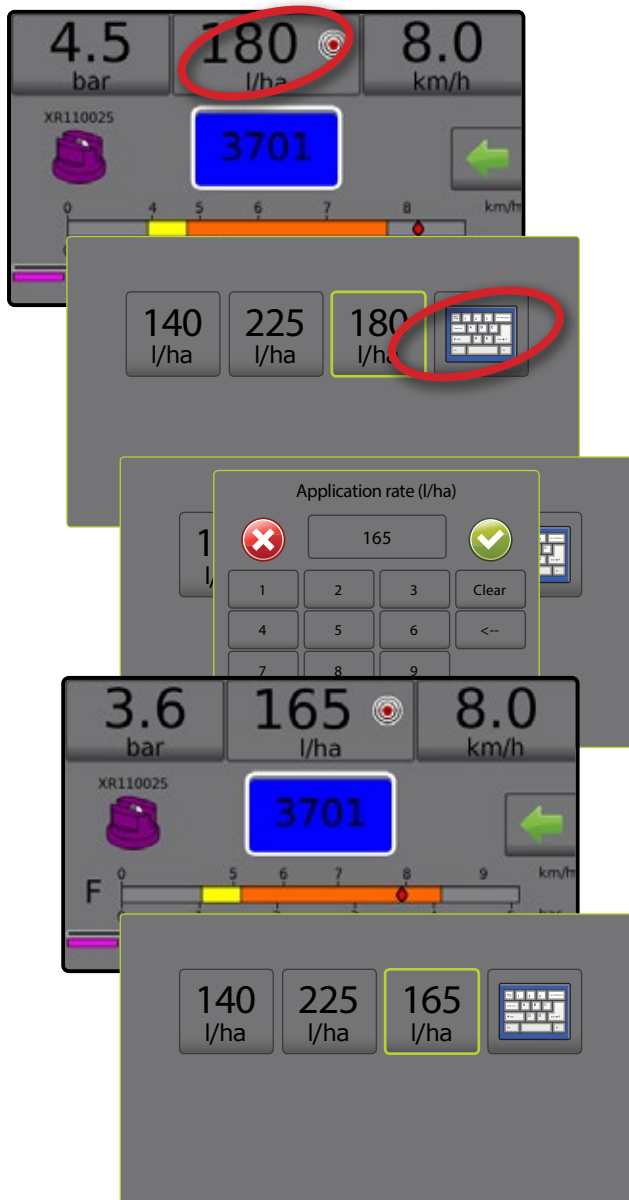

Settings

1. From the Home screen, press the SETTINGS button .
2. Press **Job parameters**.
3. Select Application rate number 1 **1**.
4. Select an application rate **2** to be associated with number 1.
5. Repeat steps 3 and 4 for Application rate numbers 2 and 3.

Figure 1-13: Establish preset target application rate 2





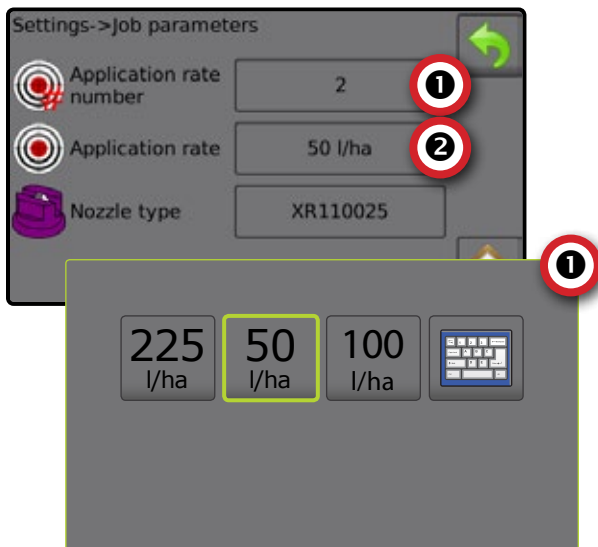

Target rate percentage increase/decrease

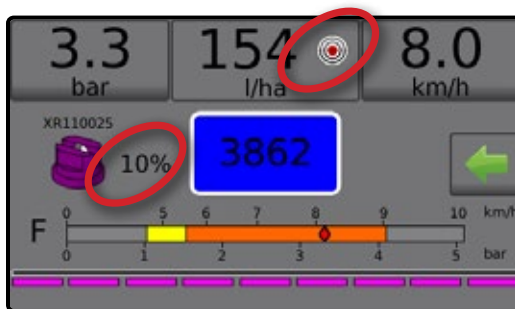
Target rate boost/step percent increase/decrease buttons increase/decrease the application target rate per the established percentage set in the Settings->Machine->Operation setup screen under Application rate step.

Figure 1-14: Target rate boost/step percent



Increase/decrease percentage

1. From the Operation screen, press the OPTIONS tab  to display the Operation menu.
2. Press the Boost/step percent increase/decrease buttons   to adjust application rates.
3. Press the Close menu button .

Return to preset target rate



1. From the Operation screen, press the OPTIONS tab  to display the Operation menu.
2. Press **0%** to return to the preset target rate.
3. Press the Close menu button .

Figure 1-15: Application rate step



Change application rate step

Application rate step is the percent of increase/decrease boost of the active application rate at which the product is applied. Range is 1 to 20%.

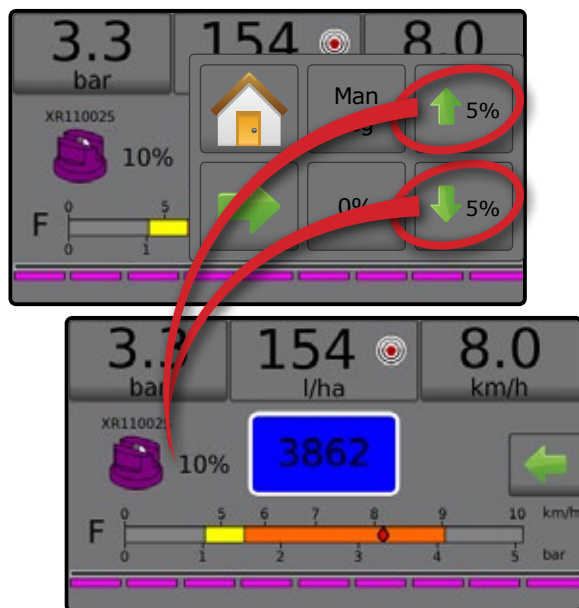

1. From the Home screen, press the **SETTINGS** button .
2. Press **Machine**.
3. Press **Operation**.
4. Press Application rate step value **1**.
5. Select an application rate step.
6. Press RETURN arrow  to return to the Machine screen.

Figure 1-16: Operation



NOZZLE SELECTION

Nozzles must be preset to be available for current nozzle selection. Presets allow saving of up to five (5) nozzles for quick recall.

Selecting the current nozzle

1. From the Operation screen, press the **CURRENT NOZZLE**  to display the Preset nozzle menu.
2. Select a nozzle type from among five (5) nozzle presets.

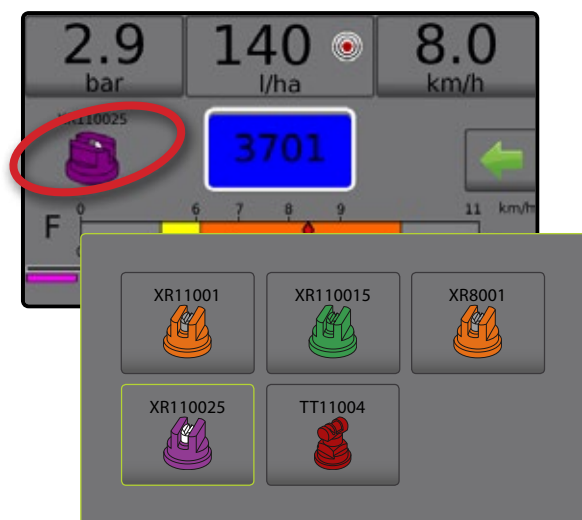

NOTE: Current nozzle can also be selectable on the Settings->Job parameters screen.

Figure 1-17: Nozzle type on Operation screen



Presetting nozzles

Nozzle preset setup establishes up to five (5) sets of nozzle options setting the nozzle type, capacity, low/high pressure limit, reference flow and reference pressure. For more information see Settings->Machine->Implement parameters->Nozzle preset setup.

1. From the Home screen , press the **SETTINGS** button .
2. Press **Machine**.
3. Press **Implement parameters**.
4. Press **Nozzle preset setup**.
5. Select Nozzle preset number **1** **1**.
6. Select Nozzle series **2**.
7. Select Nozzle capacity **3**.
8. Repeat steps 5, 6 and 7 for Nozzle preset numbers 2 to 5.
9. OPTIONAL: Press NEXT PAGE arrow  **4** to adjust the settings for Low pressure limit, High pressure limit, Reference flow and Reference pressure. Each of these settings are specific to the current nozzle preset number.

Radion 8140 automatic sprayer control

Figure 1-18: Establish nozzle presets

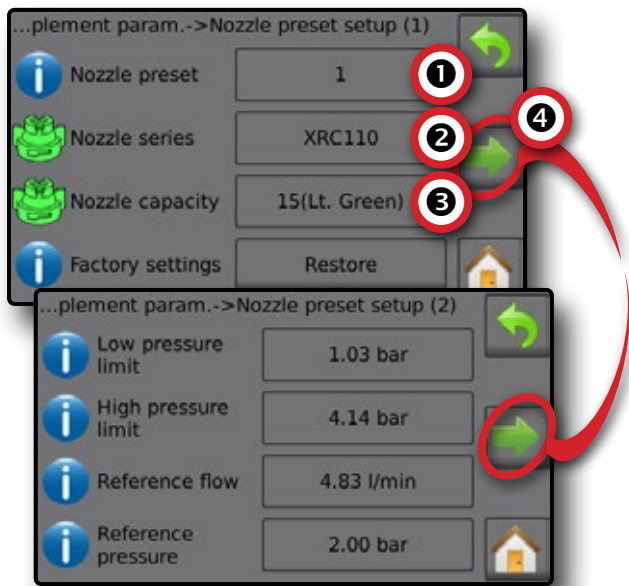

TANK

Tank displays or give access to:

- ▶ Actual content – displays the current volume of content in the tank. Manual adjustment is directly relate to OEM fitted equipment. The volume cannot be manually adjusted if a Tank sensor is active.
- ▶ Tank filling – establishes the amount of actual and desired material in the tank and the density of that material. Options displayed directly relate to OEM fitted equipment. Different options will be available depending upon if a Tank sensor or Fill flow sensor is active. See Settings->Machine->Filling for additional information.

1. Press TANK **100**.

2. Press setting value to adjust settings as needed:

- ◀ Actual content (unavailable when Tank sensor is active)
- ◀ Full tank (unavailable when Tank sensor or Fill flow sensor is active)
- ◀ Density type
- ◀ Density factor (available when Density type is Fertiliser)
- ◀ Desired content (available when Tank sensor or Fill flow sensor is active)
- ◀ Automatic filling (available when Tank sensor or Fill flow sensor is active)

3. Press RETURN arrow  to return to the Operation screen.

Figure 1-19: Tank filling



ALARM WARNING

If there is an active alarm, an Alarm warning icon will appear next to the Tank. For a list of Alarm message codes see Appendix C – Alarm configurations.

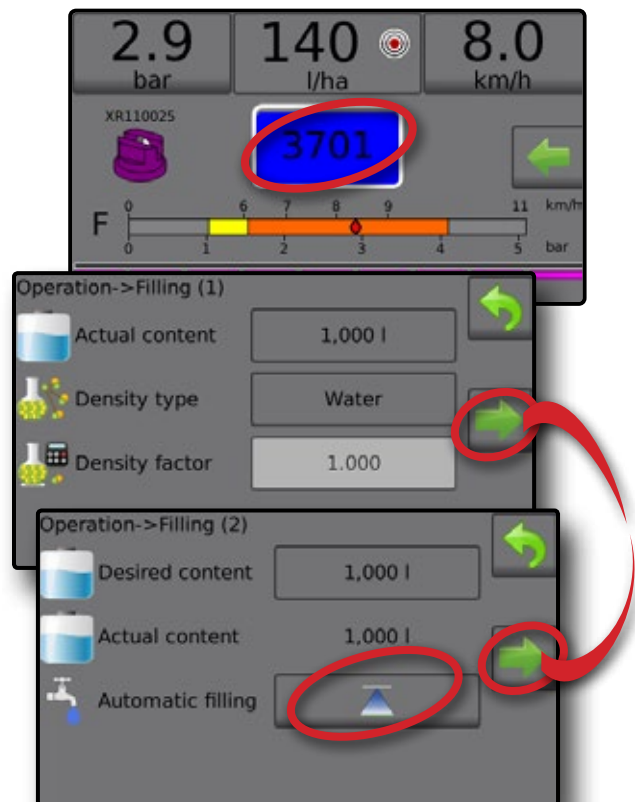
1. Press ALARM WARNING icon  to display a list all active alarms.

Figure 1-20: Active alarm warning list

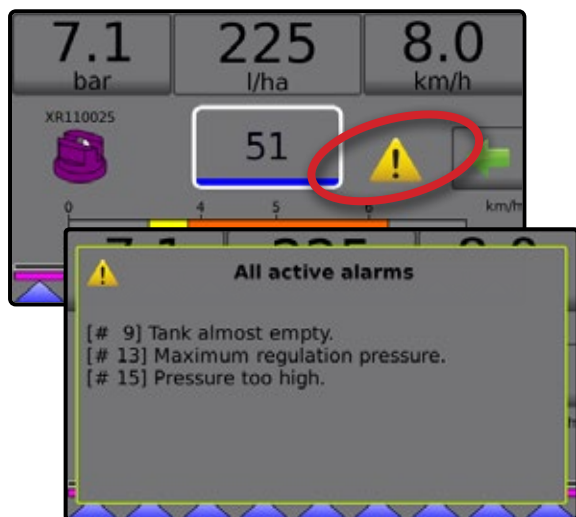

Set up alarms



1. From the Home screen, press the SETTINGS button .
2. Press **Machine**.
3. Press **Alarms**.
4. Press setting value to adjust settings as needed:
 - ◀ Minimum tank content
 - ◀ Flow/pressure cross check (alarm active only when both a Flow sensor and Liquid pressure sensor are active)
 - ◀ Section output low
5. Press RETURN arrow  to return to the Machine screen.

Figure 1-21: Alarms



PRESSURE GAUGE

The Pressure gauge displays current pressure compared with the recommended pressure range. Pressure sensor options are used to enter the sensor manufacturer maximum pressure rating and to set high and low user-determined pressure alarms.

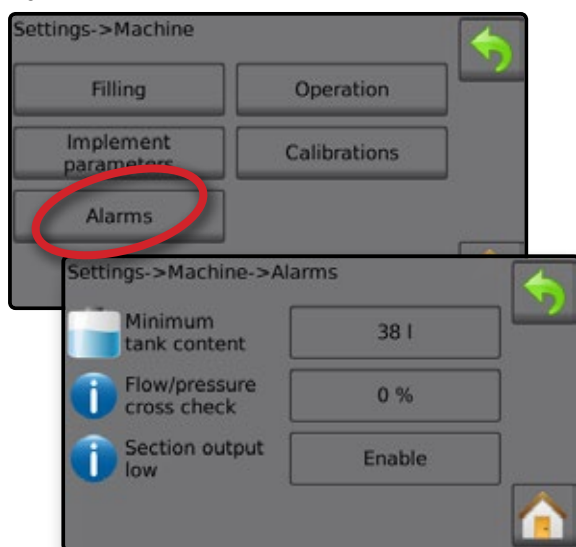
Figure 1-22: Pressure gauge example

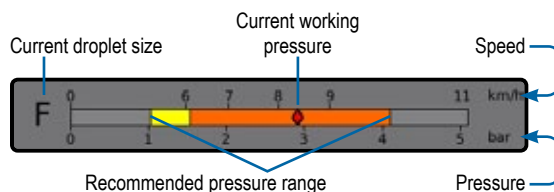

Recommended pressure range

Displays the recommended pressure range for the selected nozzle. The pressure range will change depending upon the selected nozzle, target application rate (including boost/step percent increase/decrease) and working speed.

IMPORTANT! Always refer to the recommended pressure range as failure to do so may result in uneven spray patterns.

Current working pressure

Displays the current working pressure.

NOTE: This pressure range should not exceed the recommended pressure range.

IMPORTANT! Always refer to the recommended nozzle pressure values when setting nozzle pressure.

Current droplet size

A single nozzle can produce different droplet size classifications at different pressures. The colours displayed in the recommended pressure range are directly associated with the current droplet sizes. The droplet size displays as one (1) of eight (8) classification categories.

Table 1-1: Droplet size chart

Category	Symbol	Colour code
Extremely fine	XF	Violet
Very fine	VF	Red
Fine	F	Orange
Medium	M	Yellow
Coarse	C	Blue
Very coarse	VC	Green
Extremely coarse	XC	White
Ultra coarse	UC	Black

Radion 8140 automatic sprayer control

INTRODUCTION

OPERATION

SETTINGS

DATA

CONSOLE

TOOLS

APPENDIX

BOOM SECTIONS & SWITCHES

The console operates with, nine (9), seven (7) or five (5) section switches (depending on console model) and one (1) Master switch. In the nine (9), seven (7) and five (5) section switch models, each section switch is associated with one of up to the same number of sections on the boom and illustrated on the Operation screen.

Nine (9) switch consoles are capable of supporting up to 13 boom sections. The boom sections are paired across the nine (9) switches evenly but will work as individual sections in ASC mode.

NOTE: Although the Number of sections range is up to 13, the max. number of physical switches are still nine (9).

- ▶ Switches – control individual boom sections
 - ◀ On – Flip the switch up
 - ◀ Off – Flip the switch down
- ▶ Master switch – opens/closes the main product valves and enables/disables power to individual boom section on/off switches
 - ◀ cannot be activated outside of the Operation screen
- ▶ Boom sections spray status – displays the status of the section switches in association to the master switch. Number of sections shown is established in Settings->OEM->Implement parameters.
 - ◀ Section on, master switch on – spray is blue
 - ◀ Section off, master switch on – spray is white
 - ◀ Master switch off – spray not shown

Figure 1-23: Master switch, 9 section switches



Figure 1-24: Boom sections

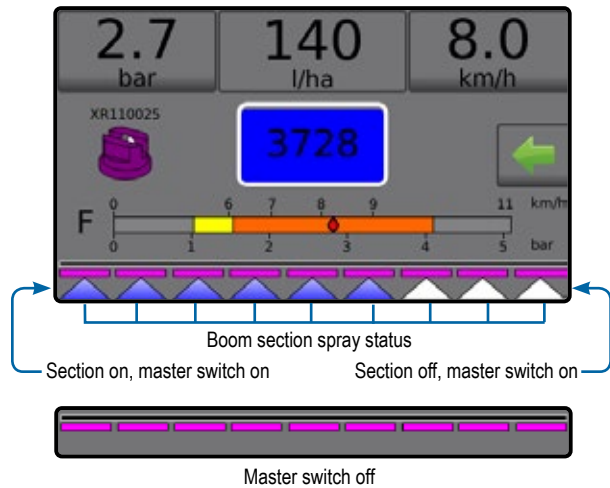

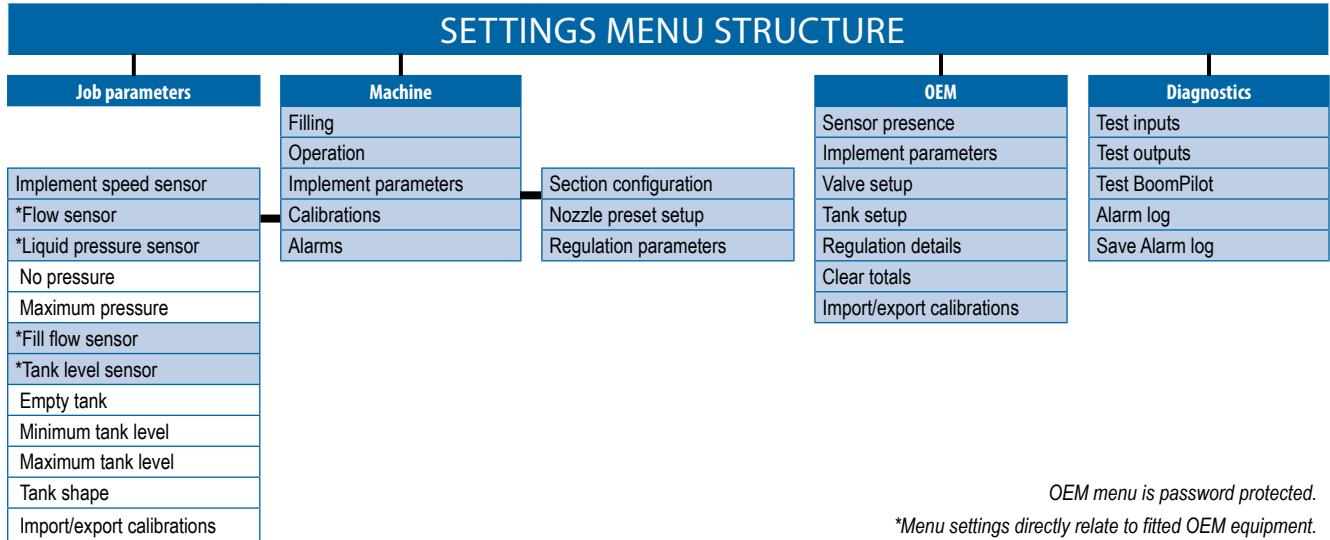

Table 1-1: Pairing key for 9 physical section switches operating with 10, 11, 12 and 13 boom sections

Section switches 1-9	Boom section pairing greater than 9 boom sections			
	10 sections	11 sections	12 sections	13 sections
1	1	1	1	1
2	2	2	2	2
3	3	3	3	3 and 4
4	4	4 and 5	4 and 5	5 and 6
5	5 and 6	6	6 and 7	7
6	7	7 and 8	8 and 9	8 and 9
7	8	9	10	10 and 11
8	9	10	11	12
9	10	11	12	13

CHAPTER 1 – SETTINGS

 The main settings menu contains four (4) options: Job parameters, Machine, OEM and Diagnostics. Each option directly accesses settings or additional menus. When a job is active some setup options are unavailable.



OEM menu is password protected.

**Menu settings directly relate to fitted OEM equipment.*

1. From the Home screen, press the SETTINGS button .

2. Select from:

- ▶ Job parameters – configures current target application rate settings, current nozzle and idle pressure
- ▶ Machine – configures machine settings:
 - ◀ Filling – establishes the amount of actual and desired material in the tank and the density of that material
 - ◀ Operation – establishes application rate step, speed source, simulated speed and minimum speed
 - ◀ Implement parameters – establishes the section configuration, nozzle preset setup and regulation parameters
 - ◀ Calibrations – establishes either manual or automatic settings of sensors
 - ◀ Alarms – establishes alarms on/off or sets trigger levels
- ▶ OEM – directly related to the fitted OEM equipment and is password protected.
 - ◀ Sensor presence – establishes sensors for Flow, Liquid pressure, Fill flow, and the Tank
 - ◀ Implement parameters – establishes the number of sections, circulation and display rate smoothing
 - ◀ Valve setup – establishes the regulation valve type, section valve behaviour and section valve type
 - ◀ Tank setup – establishes maximum and minimum tank content, auto-filling mode and auto-filling offset value
 - ◀ Regulation details – adjusts control of the regulation valve
 - ◀ Clear total – deletes the total count system counter for area, volume and time and resets to the default settings
 - ◀ Import/export – import or export settings

- ▶ Diagnostic – troubleshoots input/output of the controller (sensor or actuator) or BoomPilot
 - ◀ Test inputs – displays the input high and low values on the installed sensors
 - ◀ Test outputs – sets the Liquid Valve PWM Duty Cycle percentage and checks if Master Valve, Fill Valve and Section Valves are on/off
 - ◀ Test BoomPilot – displays automatic boom section control correction, mode and section input status (only available when feature is unlocked)
 - ◀ Alarm log – displays the last 50 alarms
 - ◀ Save alarm log – saves the alarm log

Figure 1-1: Settings options

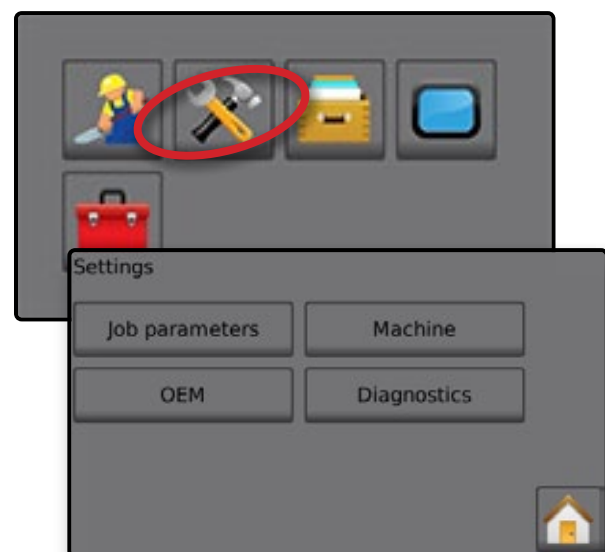

Radion 8140 automatic sprayer control

INTRODUCTION

OPERATION

SETTINGS

DATA

CONSOLE

TOOLS

APPENDIX

JOB PARAMETERS

Job parameters configures the target application rate, current nozzle and idle pressure settings. Selections are also active on the Operation screen.

SETTINGS MENU STRUCTURE

Job parameters
Application rate number
Application rate
Nozzle type
*Idle pressure

Machine

OEM

Diagnostics

*Menu settings directly relate to fitted OEM equipment



- From the Home screen, press the SETTINGS button .
- Press **Job parameters**.
- Press a setting value to adjust settings as needed.
 - ◀ Target application rate number
 - ◀ Target application rate
 - ◀ Nozzle type
 - ◀ Idle pressure (available when Liquid pressure sensor is active)
- Press the RETURN arrow  to return to the main Settings screen.

Figure 1-2: Job parameters



Target application rate number

Target application rate number specifies up to three (3) target application rate presets from which to select.

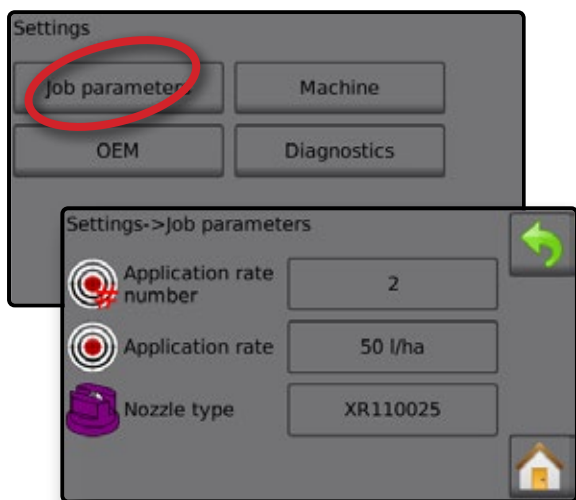
Target application rate

Target application rate defines the target rate of product to apply for the selected number. These settings will be the same for all active jobs. Range is 0 to 6,554 litres/hectare.

Nozzle type

Nozzle type selects the current nozzle type from the five (5) nozzle presets. This selection is also active and adjustable on the Operation Screen. This setting does not change with when the target application rate number changes.

Establish nozzle presets under Settings->Machine->Implement parameters->Nozzle preset setup.

Idle pressure

Idle pressure value sets the minimum pressure when the master valve is off when using a non-circulation system and a Liquid pressure sensor is present. Range is 0.00 to 50.00 bar.

Establish preset target application rates



- From the Home screen, press the SETTINGS button .
- Press **Job parameters**.
- Select Application rate number 1 .
- Select an application rate  to be associated with number 1.
- Repeat steps 3 and 4 for Application rate numbers 2 and 3.

Figure 1-3: Establish preset target application rate 2



The target application rates are accessed on the Operation screen by pressing the Application rate section of the Information bar.

MACHINE

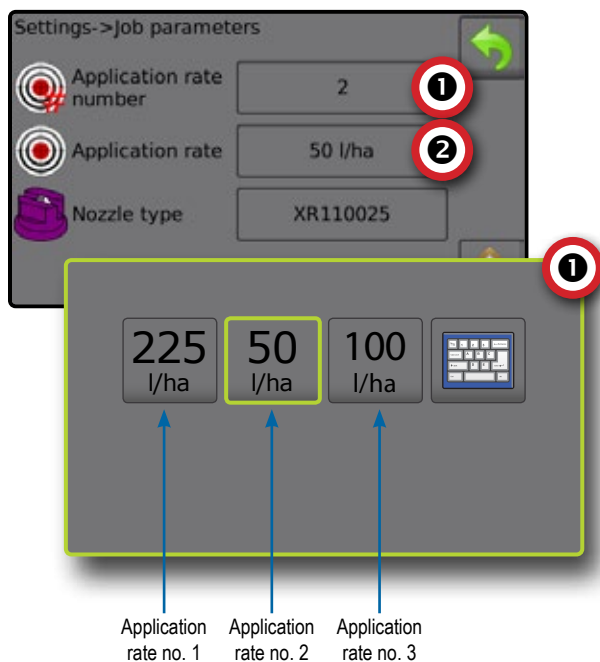
Machine configures machine settings. Options include Filling, Operation, Implement parameters, Calibrations and Alarms.

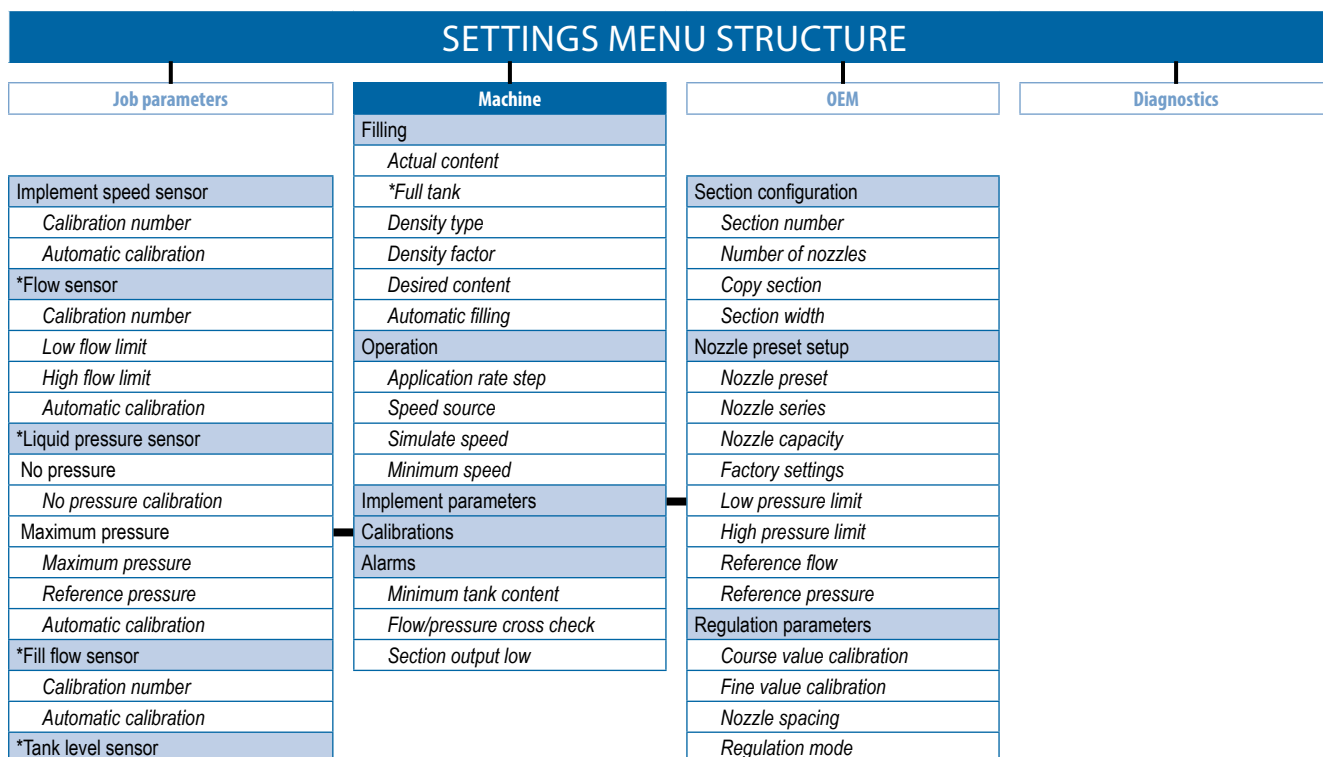

*Menu settings directly relate to fitted OEM equipment.

- ▶ Calibrations – establishes either manual/automatic settings of the following sensors:
 - ◀ Implement speed sensor
 - ◀ Flow sensor
 - ◀ Liquid pressure sensor
 - ◀ Fill flow sensor
 - ◀ Tank level sensor
- ▶ Alarms – establishes alarms on/off and sets their trigger levels

1. From the Home screen, press the SETTINGS button .

2. Press **Machine**.

3. Select from:

- ▶ Filling – establishes the amount of actual and desired material in the tank and the density of that material
- ▶ Operation – establishes application rate step, speed source, simulated speed and minimum speed
- ▶ Implement parameters
 - ◀ Section configuration – sets the number of nozzles on the boom which determines the spraying width during application
 - ◀ Nozzle preset setup – establishes options for up to five (5) nozzles including series, capacity, low/high pressure limits, reference flow and reference pressure
 - ◀ Regulation parameters – adjusts valve calibration and nozzle spacing and selects a regulation mode

4. Press RETURN arrow  to return to the main Settings screen.

Figure 1-4: Machine



Radion 8140 automatic sprayer control

INTRODUCTION

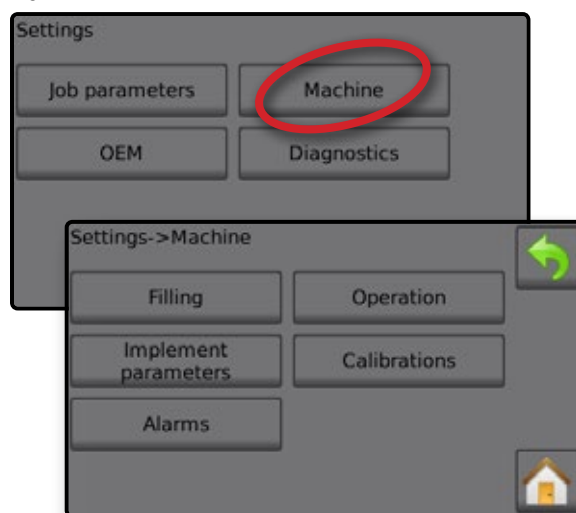
OPERATION

SETTINGS

DATA

CONSOLE

TOOLS



APPENDIX

Filling

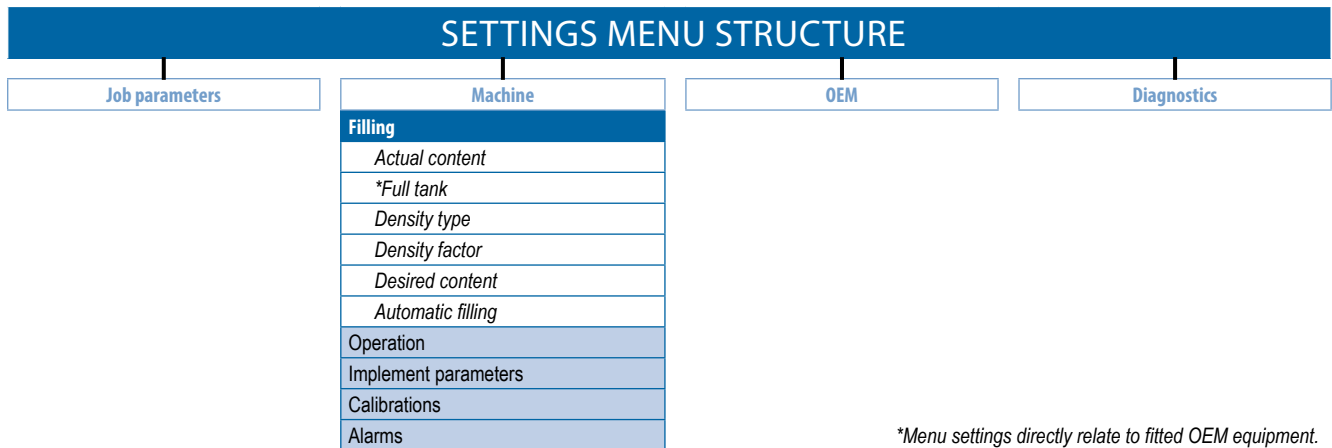
Filling establishes the amount of actual and desired material in the tank and the density of that material. Options displayed directly relate to OEM fitted equipment. Different options will be available depending upon if a Tank sensor or Fill flow sensor is active.



*Menu settings directly relate to fitted OEM equipment.

1. From the Home screen, press the SETTINGS button .
2. Press **Machine**.
3. Press **Filling**.
4. Press setting value to adjust settings as needed:
 - ◀ Actual content (unavailable when Tank sensor is active)
 - ◀ Full tank (unavailable when Tank sensor or Fill flow sensor is active)
 - ◀ Density type
 - ◀ Density factor (available when Density type is Fertiliser)
 - ◀ Desired content (available when Tank sensor or Fill flow sensor is active)
 - ◀ Automatic filling (available when Tank sensor or Fill flow sensor is active)
5. Press RETURN arrow  to return to the Machine screen.

NOTE: Maximum tank content is established in Settings->OEM->Tank setup.

When a Tank sensor is active, the actual content can not be changed manually.

If "Fertiliser" is selected, a Density factor option is active.

Figure 1-5: Filling

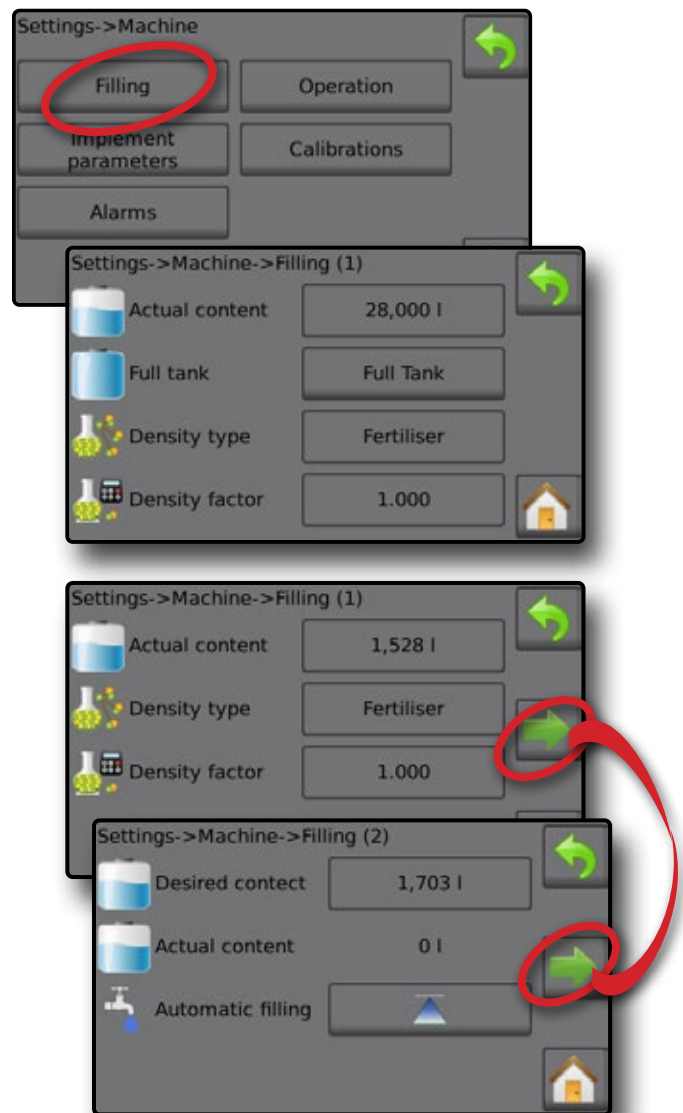

Filling from Operation screen

All filling settings may be accessed from the Operation screen by pressing the TANK **100**.

Figure 1-6: Filling from Operation screen

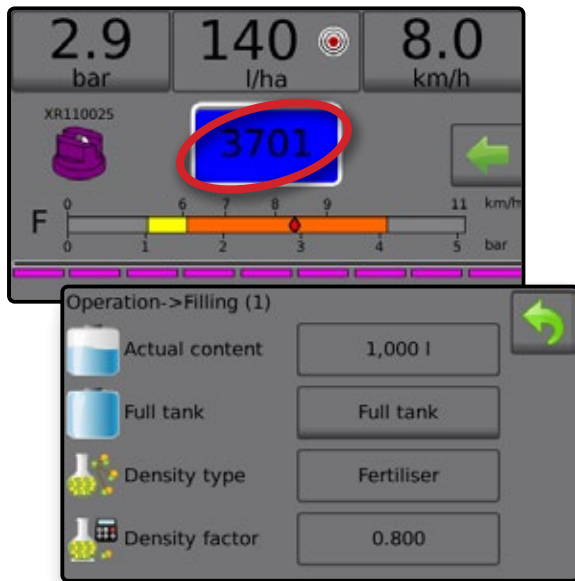

Screen (1)

Actual content

Actual content displays the current volume of content in the tank. Manual adjustment is directly relate to OEM fitted equipment. The volume cannot be manually adjusted if a Tank sensor is active.

NOTE: Maximum tank content is established in Settings->OEM-> Tank setup.

When available, this number repopulates when the **Full Tank** option is pressed.

Full tank

Full Tank returns the Actual content volume value to the maximum volume of the tank.

NOTE: When a Tank sensor or Fill flow sensor is active, the Full tank option is not displayed.

Density type

Density establishes the density of the material applied. It can be set to either fertiliser or water.

NOTE: If Fertiliser is selected, a Density factor option is active.

Density factor

Density Factor establishes the weight per volume setting based on the type of fertiliser used. Range is 0.8 to 2.0 kg/l.

NOTE: If water is selected, a Density factor option is inactive.

The fertiliser's ability to flow is affected by a number of factors. These factors may vary with each batch and it may change due to weather (humidity, etc.). In order to accommodate for this, the job computer uses a density factor to compensate for the nature of the applied fertiliser.

The default value of "1.00" corresponds with the specific gravity of water and is correct for most pesticide applications. Occasionally some spray solutions, such as fertiliser, have different densities. If using such a material, a new value should replace the default value. The chart to the below can help determine the specific gravity of other solutions.

Table 1-1: Specific gravity

Weight of solution per litre/lb		Specific gravity
3.2 Kg	7.0 lb (UK)	0.84
3.6 Kg	8.0 lb (UK)	0.96
1 Kg/L - water	8.34 lb - water (UK)	1.00
4.5 Kg	10.0 lb (UK)	1.20
4.8 Kg - 28%N	10.65 lb - 28%N (UK)	1.28
4.9 Kg - 30%N	10.85 lb - 30%N (UK)	1.30
5.0 Kg	11.0 lb (UK)	1.32
5.4 Kg	12.0 lb (UK)	1.44
6.4 Kg	14.0 lb (UK)	1.68

NOTE: Water weighs 1 Kg/L or 8.34 lb/gal (UK)

The Specific gravity can be calculated as follows:

$$\text{Specific gravity} = \frac{\text{Weight of solution}}{\text{Weight of water}}$$

Screen (2)

These options are only displayed when a Tank sensor or Fill flow sensor is active.

Desired content

Desired Content establishes the desired maximum content volume. The volume can be manually adjusted.

Actual content

Actual Content displays the current volume of content in the tank. The volume can be manually adjusted on the Filling (1) screen.

Automatic filling

Automatic filling starts and stops the automatic filling process.

Radion 8140 automatic sprayer control

INTRODUCTION

OPERATION

SETTINGS

DATA

CONSOLE

TOOLS

APPENDIX

Operation

Operation configures application rate steps and speed settings relating to operations. Options include Application rate step, Speed source, Simulate speed and Minimum speed.

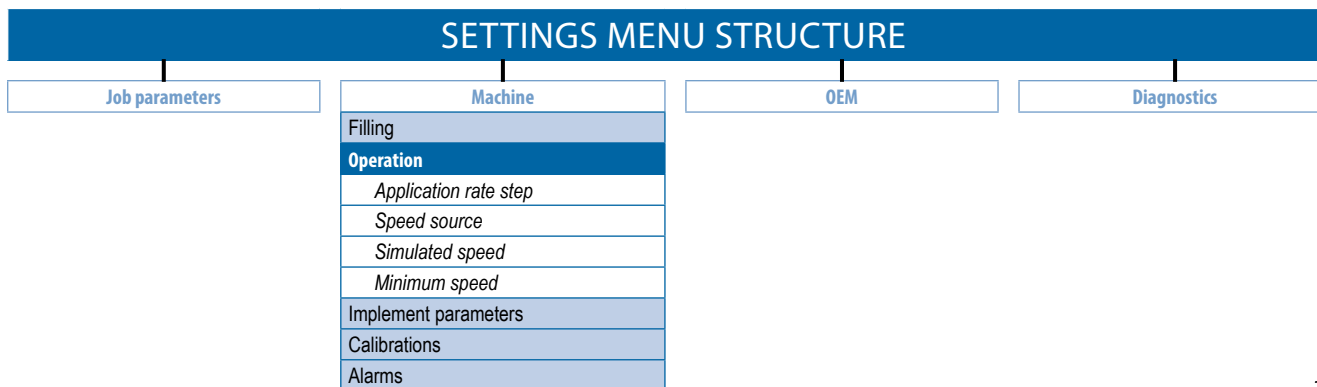

1. From the Home screen, press the SETTINGS button
2. Press **Machine**.
3. Press **Operation**.
4. Press setting value to adjust settings as needed:
 - ◀ Application rate step
 - ◀ Speed source
 - ◀ Simulated speed (available when Speed source is Simulated)
 - ◀ Minimum speed
5. Press RETURN arrow to return to the Machine screen.

Figure 1-7: Operation



Application rate step

Application rate step is the percent of increase/decrease boost of the active application rate at which the product is applied. Range is 1 to 20%.

Application rate boost/step percent is used on the Operation screen from the Options tab while in Automatic mode.

Figure 1-8: Application rate step on Operation screen

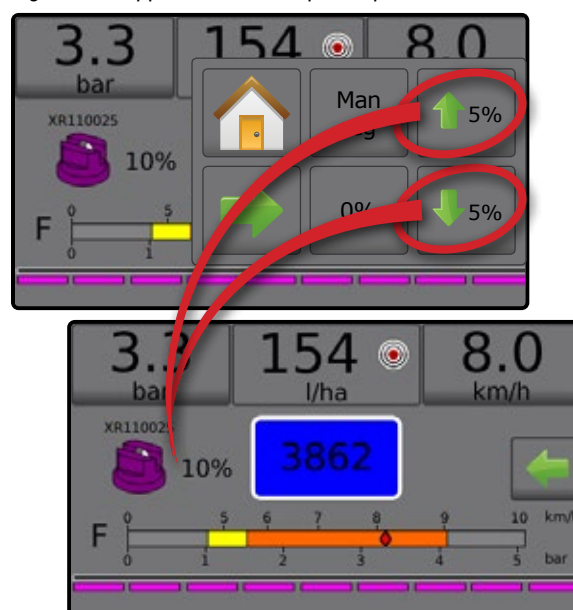

Speed source

Speed source selects whether to base the machine speed on input from the CAN, an Implement or a Simulated source.

- ◀ Implement – allows for speed to be supplied from an implement speed sensor. Calibration of the implement speed sensor is done.

NOTE: Calibration of the implement speed sensor is established in the Settings->Machine->Calibrations->Implement speed sensor options.

- ◀ Simulated – allows for simulated speed to be entered
- ◀ CAN – uses speed supplied by the CAN

NOTE: An alarm will sound at start up when active.

Simulated speed

Simulated speed establishes a speed for using the Simulated speed source. Range is 0 to 99.9 kilometres/hour.



Minimum speed

Minimum speed establishes the minimum forward speed at which the system should automatically switch the main valve off. Range is 0 to 99.9 kilometres/hour.

Implement parameters

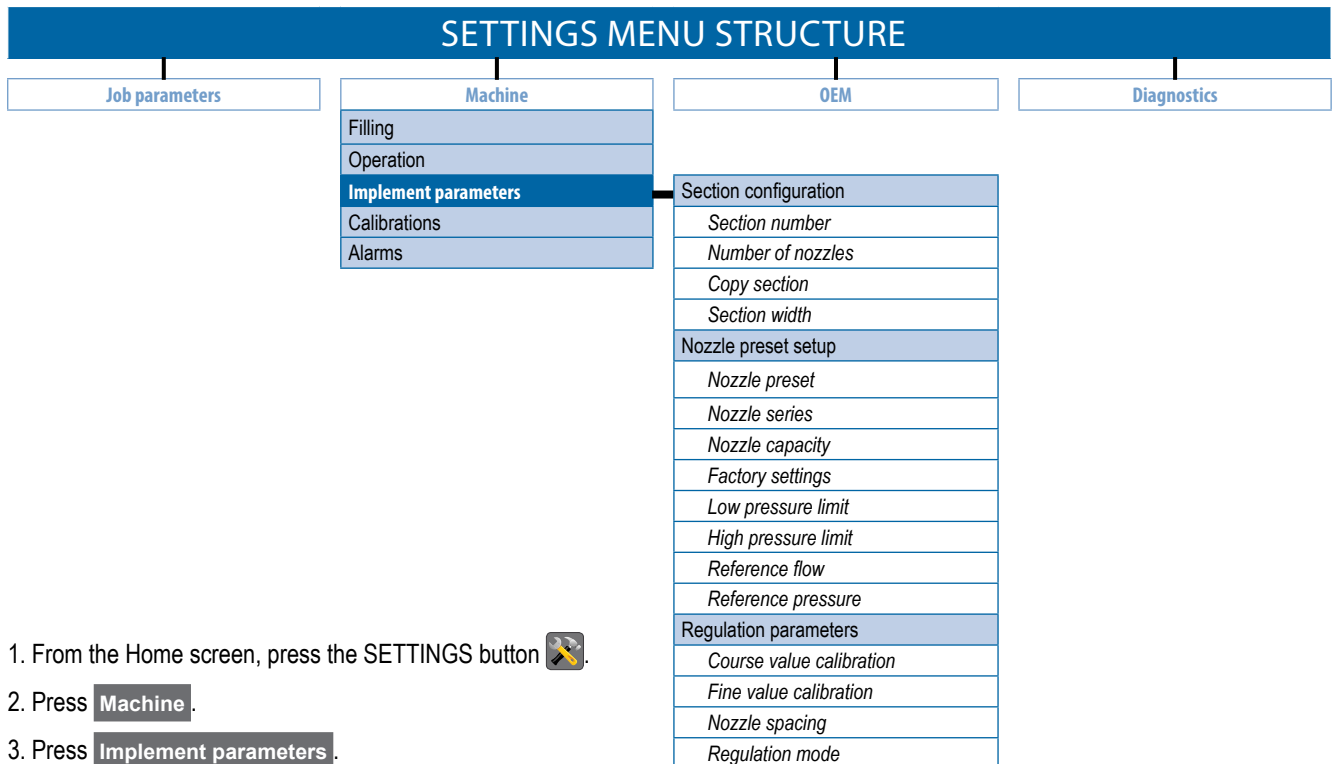
Implement parameters establishes: the section configuration including the number of nozzles per section; nozzle configuration including up to five (5) presets; and regulation parameters including valve calibration, nozzle spacing and regulation mode.



- From the Home screen, press the SETTINGS button .
- Press **Machine**.
- Press **Implement parameters**.
- Select from:
 - ▶ Section configuration – sets the number of nozzles on the boom which determines the spraying width during application
 - ▶ Nozzle preset setup – where up to five (5) sets of nozzle options can be established to set the nozzle series, capacity, low/high pressure limit, reference flow and reference pressure
 - ▶ Regulation parameters – where adjustments to the valve calibration, nozzle spacing and regulations mode can be established
- Press RETURN arrow  to return to the Machine screen.

Section configuration

Section configuration sets the number of nozzles on the boom which determines the spraying width during application.



- From the Home screen, press the SETTINGS button .
- Press **Machine**.
- Press **Implement parameters**.
- Press **Section configuration**.
- Press setting value to adjust settings as needed:
 - ◀ Section number
 - ◀ Number of nozzles
 - ◀ Copy section
 - ◀ Section width
- Press RETURN arrow  to return to the Implement parameters screen.

Figure 1-9: Implement parameters



Radion 8140 automatic sprayer control

INTRODUCTION

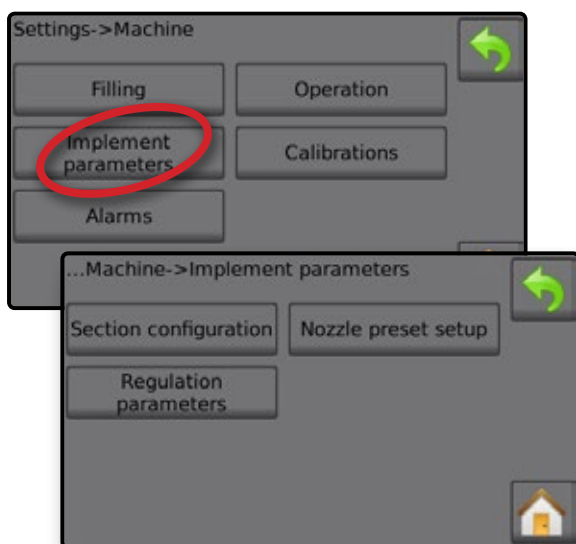
OPERATION

SETTINGS

DATA

CONSOLE

TOOLS

APPENDIX

Figure 1-10: Section configuration

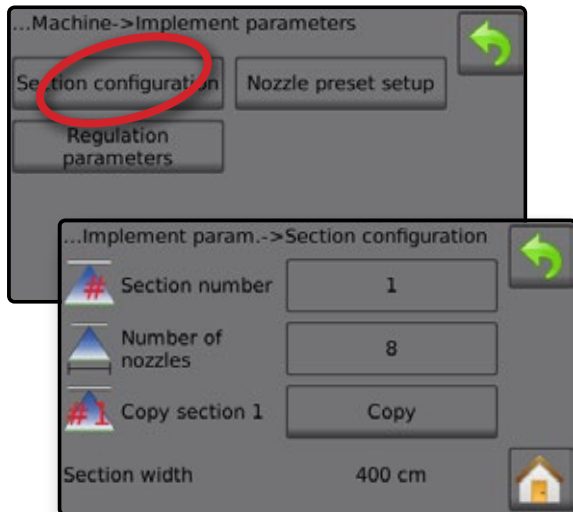

Section number

Section number establishes the current section number to which changes can be made. Sections are numbered from left to right while facing in the machine forward direction.

NOTE: The number of available sections is established in the OEM menu and limited by the sections available on the console.

Number of nozzles

The number of nozzles in the current section number. Range is 0 to 200.

Copy section

Copy section sets all Number of nozzles counts to the same count for all boom sections based upon the current Section number.

Section width

Section width displays the width for the current section. The width is calculated based on the number of nozzles established in the Number of nozzle section and nozzle spacing established under: Settings->Machine->Implement parameters->Regulation parameters->Nozzle spacing.

Establish number of nozzles

1. From the Home screen, press the SETTINGS button .
2. Press **Machine**.
3. Press **Implement parameters**.
4. Press **Section configuration**.
5. Select Section number ①.
6. Set the number of nozzles ② for the selected section number.
7. Repeat steps 5 and 6 for additional Section numbers as available.
8. OPTIONAL: If all sections have the same number of nozzles, press **Copy** ③ to set all sections to the current number of nozzles.

Figure 1-11: Establish number of nozzles



Nozzle preset setup

Nozzle preset setup establishes up to five (5) sets of nozzle options setting the nozzle type, capacity, low/high pressure limit, reference flow and reference pressure.

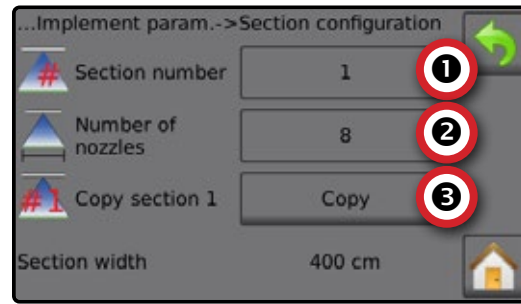
NOTE: Settings on both screen 1 and screen 2 are specific to the currently selected Nozzle preset number.



1. From the Home screen, press the SETTINGS button .
2. Press **Machine**.
3. Press **Implement parameters**.
4. Press **Nozzle preset setup**.
5. Press setting value to adjust settings as needed:
 - ◀ Nozzle preset (number)
 - ◀ Nozzle series
 - ◀ Nozzle capacity
 - ◀ Factory settings
 - ◀ Low pressure limit
 - ◀ High pressure limit
 - ◀ Reference flow
 - ◀ Reference pressure
6. Press RETURN arrow  to return to the Implement parameters screen.

Figure 1-12: Nozzle preset setup



Screen (1)

Nozzle preset

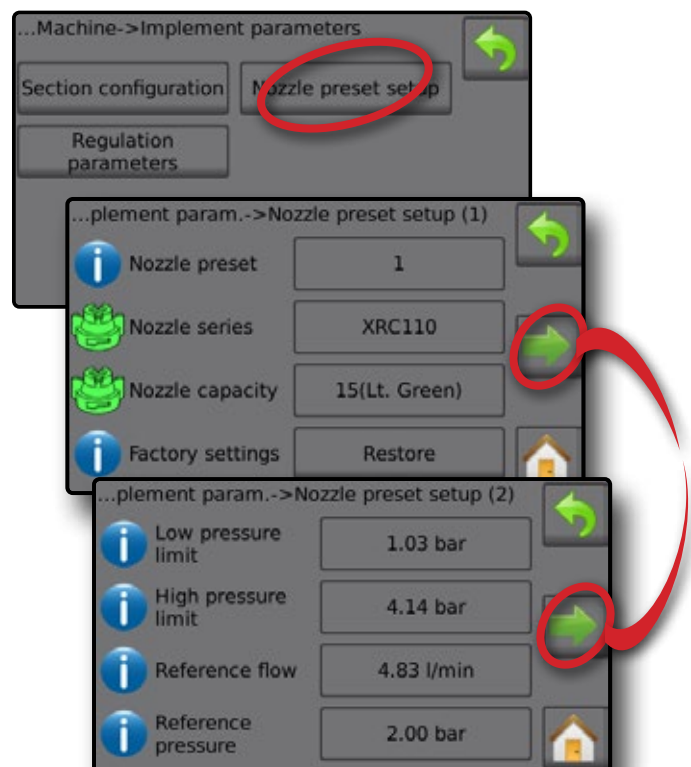
Nozzle preset allows saving of up to five (5) nozzles for quick recall. Each preset nozzle can be selected to establish different nozzle options.

Nozzle series

Nozzle series selects the nozzle series from a general selection of established nozzles or an optional user defined nozzle.

Nozzle capacity

Nozzle capacity selects the nozzle capacity from a list of established sizes. When the nozzle series is user-defined, nozzle capacity will need to be encoded manually.

Table 1-1: Nozzle sizes and associated colours

Established tip capacities and colors			
Size	Colour	Size	Colour
01	Orange	06	Gray
015	Green	08	White
02	Yellow	10	Light Blue
025	Purple	12	Telemagenta
03	Blue	15	Light Green
04	Red	20	Black
05	Brown	30	Beige

Factory settings

Factory settings resets all nozzle settings (Low pressure limit, High pressure limit, Reference flow and Reference pressure) to the default settings for the selected nozzle capacity and series.

Screen (2)

When an established nozzle series and capacity is selected, the Low pressure limit, High pressure limit, Reference flow and Reference pressure fields automatically establishes standard settings for the specific nozzle chosen. These settings can be manually adjusted. Restore standard settings to all nozzles using the Factory settings Restore button on Screen (1).

IMPORTANT! Always refer to supplier recommended nozzle pressure values when setting nozzle pressure.

Low pressure limit

Low pressure limit establishes the limit for the lowest allowed operating pressure for the selected nozzle capacity. Range is 0.0 to 25.5 bar.

High pressure limit

High pressure limit establishes the limit for the highest allowed operating pressure for the selected nozzle capacity. Range is 0.0 to 25.5 bar.

Reference flow

Reference flow establishes the value for the volume applied over a specific time. Range is 0 to 100 litres/minute.

Reference pressure

Reference pressure establishes the pressure value at which the target application rate is true (ISO = 2 bar). Range is 0.10 to 99.99 bar.

Establish nozzle presets



- From the Home screen, press the SETTINGS button .
- Press **Machine**.
- Press **Implement parameters**.
- Press **Nozzle preset setup**.
- Select Nozzle preset number 1 **1**.
- Select Nozzle series **2**.
- Select Nozzle capacity **3**.
- Repeat steps 5, 6 and 7 for Nozzle preset numbers 2 to 5.
- OPTIONAL: Press NEXT PAGE arrow  **4** to adjust the settings for Low pressure limit, High pressure limit, Reference flow and Reference pressure. Each of these settings are specific to the current nozzle preset number.

Figure 1-13: Establish nozzle presets



Radion 8140 automatic sprayer control

INTRODUCTION

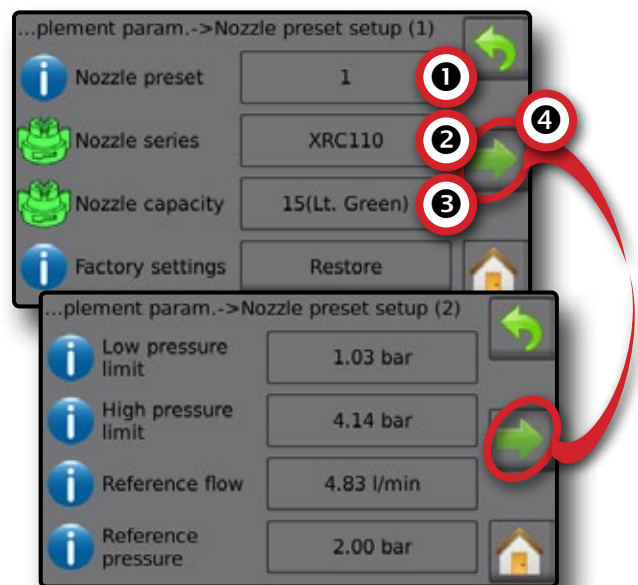
OPERATION

SETTINGS

DATA

CONSOLE

TOOLS

APPENDIX

Regulation parameters

Regulation parameters establishes adjustments to the valve calibrations, nozzle spacing and regulations mode.

NOTE: Adjusting the Valve calibration settings involves significant changes so adjustments should be made in small steps.



1. From the Home screen, press the SETTINGS button .
2. Press **Machine**.
3. Press **Implement parameters**.
4. Press **Regulation parameters**.
5. Press setting value to adjust settings as needed:
 - ◀ Coarse valve calibration
 - ◀ Fine valve calibration
 - ◀ Nozzle spacing
 - ◀ Regulation mode
6. Press the RETURN arrow  to return to the Implement parameters screen.

Figure 1-14: Regulation parameters



Coarse valve calibration

Coarse regulation value calibration allows regulating the setting of the regulating valve to accommodate different application needs. Operating conditions may necessitate a higher or lower response setting for the regulating valve. This value adjusts the setting for coarse adjustments in relation to a large percentage outside of the target application rate. Range is 0 to 19.

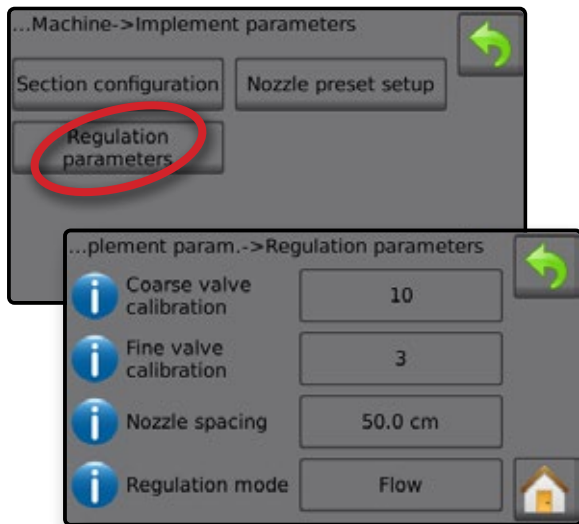
- ▶ If the system is too slow in finding the correct rate, values should be increased
- ▶ If the system is too unstable, values should be decreased

TIPS: If the system is plumbed in a bypass mode, valve setting number 9 works very well in most applications.

If the system is plumbed in a throttling mode, start with valve setting number 3 and adjust the number according to application requirements.

Low flow situations require a slower response time.

Adjusting agitation volumes, to accommodate the regulating valve to work in a more fully open position, allows for a faster response time with little to no searching.

NOTE: Adjust the setting valve to optimize system performance. If the valve seems to “search” for the programmed application rate by continuously cycling pressure up/down, reduce the number until “searching” is minimized or eliminated. Conversely, a higher number increases the valve response time and “speeds up” the rate of adjustment.

Fine valve calibration

Fine regulation value calibration allows setting the regulating valve to accommodate different application needs. Operating conditions may necessitate a higher or lower response setting for the regulating valve. Fine valve calibration adjusts the setting for the fine tune adjustment in relation to a small percentage close to the target application rate. Range is 0 to 9.

- ▶ If the system is too slow in finding the correct rate, increase values.
- ▶ If the system is too unstable, decrease values.

TIPS: If the system is plumbed in a bypass mode, valve setting number 5 works very well in most applications.

If the system is plumbed in a throttling mode, start with a valve setting number 3 and adjust the number according to application requirements.

Low flow situations require a slower response time.

Adjusting agitation volumes to accommodate the regulating valve, to work in a more fully open position, allows for faster response time with little to no searching.

NOTE: This setting value can be adjusted to optimize system performance. If the valve seems to “search” for the programmed application rate by continuously cycling the pressure up/down, reduce the number until “searching” is minimized or eliminated. Conversely, a higher number increases the valve response time and “speeds up” the rate of adjustment.

Nozzle spacing

Nozzle spacing establishes the distance between the nozzles on the boom. Range is 10 to 19,999 centimetres.

Regulation mode

Regulation mode determines if the rate control is pressure based or flow based.

Calibrations

Calibrations configures sensor parameters including Implement speed sensor, Flow sensor, Liquid pressure sensor, Fill flow sensor, and Tank level sensor. Options displayed directly relate to OEM fitted equipment.

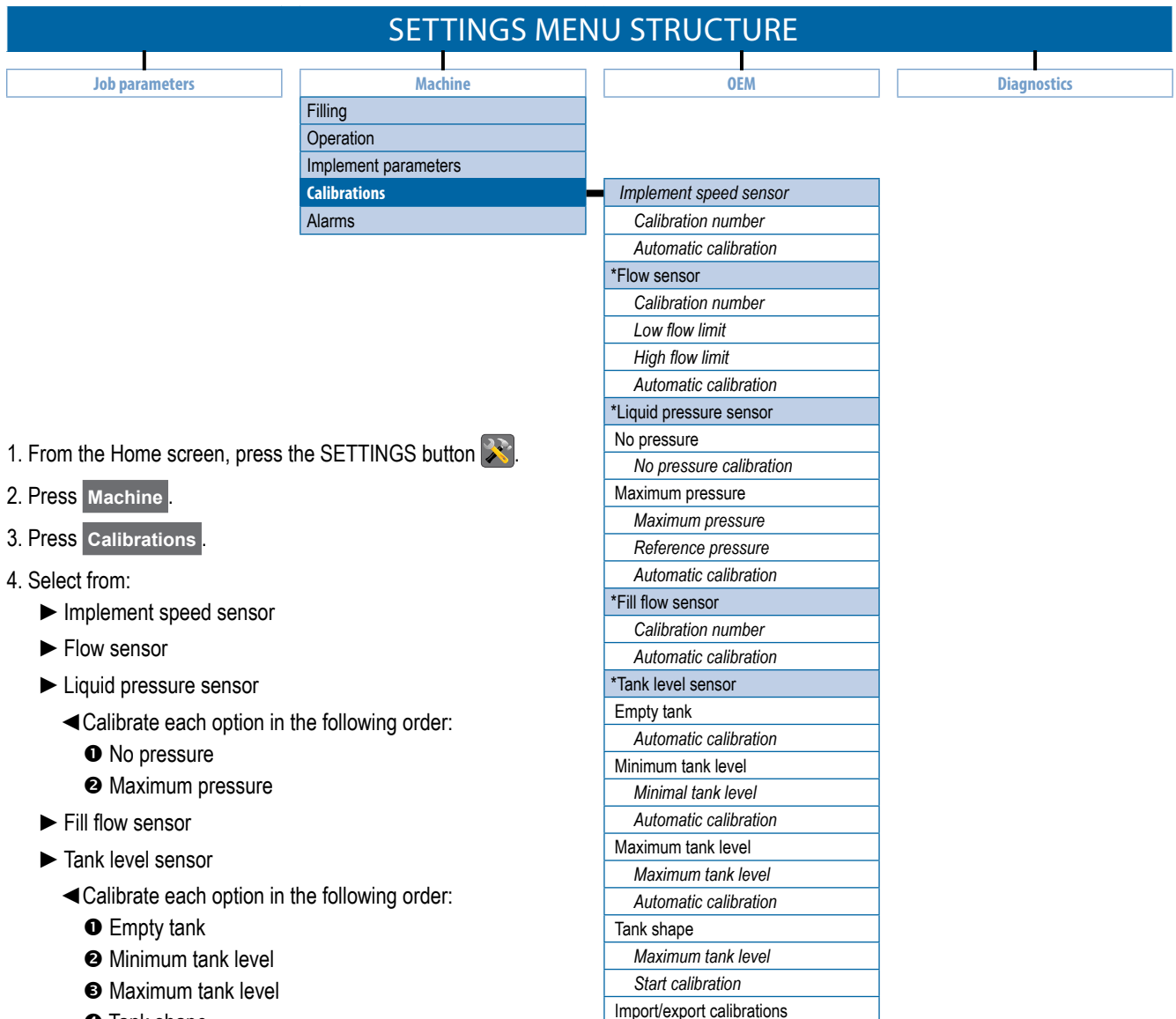

- From the Home screen, press the SETTINGS button .
- Press **Machine**.
- Press **Calibrations**.
- Select from:
 - ▶ Implement speed sensor
 - ▶ Flow sensor
 - ▶ Liquid pressure sensor
 - ◀ Calibrate each option in the following order:
 - 1 No pressure
 - 2 Maximum pressure
 - ▶ Fill flow sensor
 - ▶ Tank level sensor
 - ◀ Calibrate each option in the following order:
 - 1 Empty tank
 - 2 Minimum tank level
 - 3 Maximum tank level
 - 4 Tank shape

*Menu settings directly relate to fitted OEM equipment.

5. Press the RETURN arrow  to return to the Machine screen.

Figure 1-15: Calibrations – Tank level sensor and Fill flow sensor

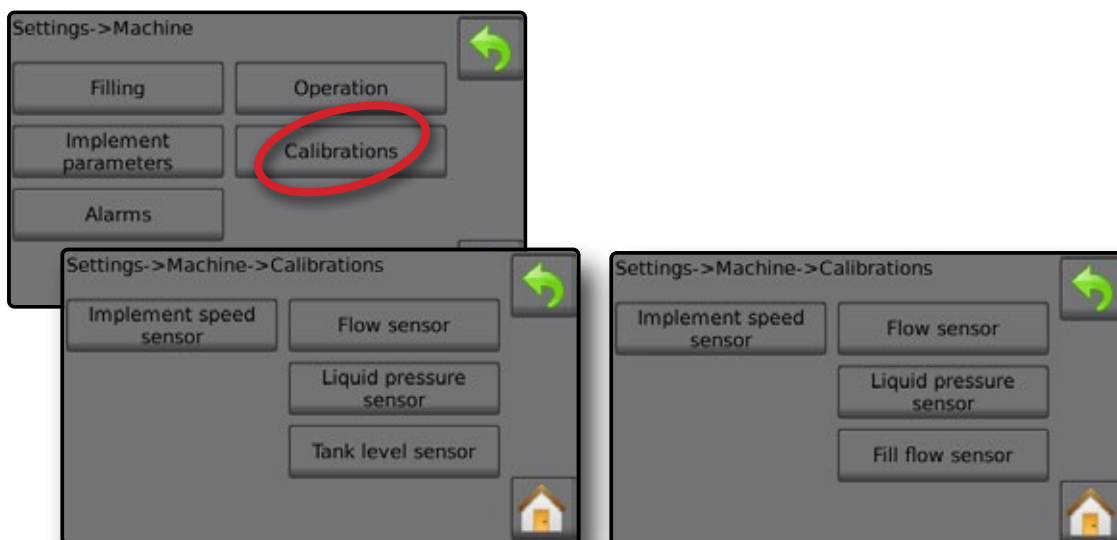

Implement speed sensor

The Implement speed sensor establishes the wheel impulses over a specified distance. Establish the value manually or automatically calibrate the value.

Figure 1-16: Implement speed sensor

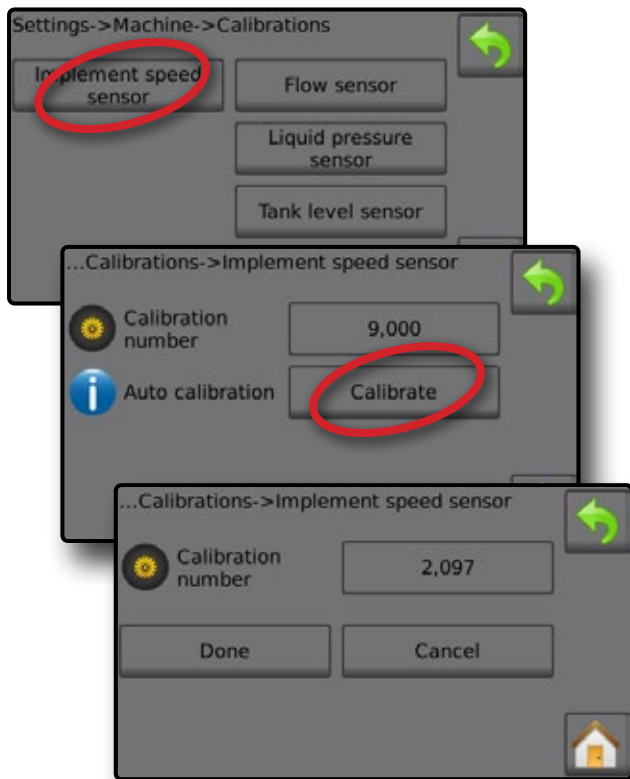

Calibration number



Automatic calibration will determine the number of impulses counted while driving 100 metres and convert the calibration number to the correct units. In manual calibration, enter the calibration number in impulses per 100 meters. Range is 0 to 65,000 impulses.

Automatic calibration

Automatic calibration establishes the impulses using the automatic calibration function.

Implement speed sensor automatic calibration

1. Press **Calibrate** to start an automatic sensor calibration.
2. Drive a distance of 100 metres.
3. Press **Done** when complete.

To cancel the calibration, press **Cancel**, RETURN arrow  or the Home button .

The counted wheel impulses will be displayed during the automatic calibration.

Flow sensor

The Flow sensor establishes the impulses per litre. Establish the value manually or automatically calibrate the value.

Figure 1-17: Flow sensor

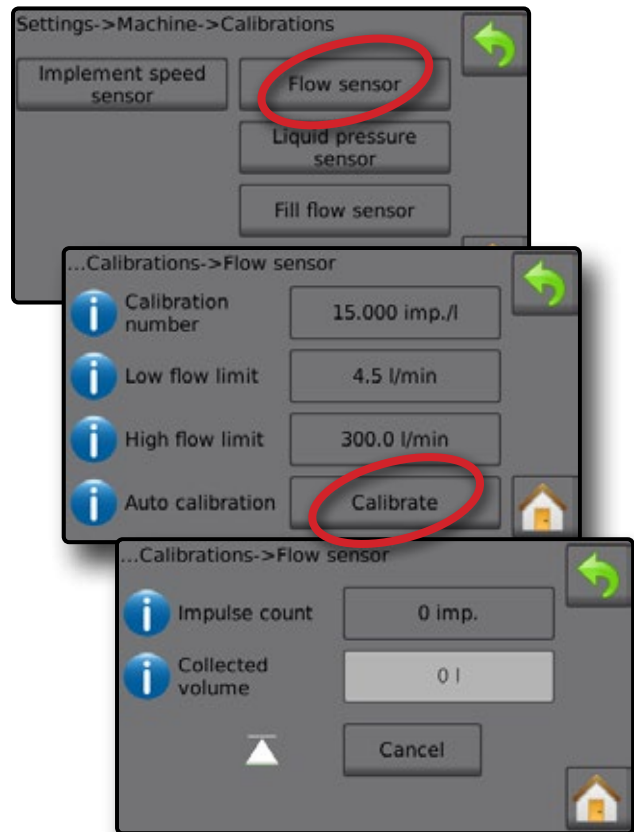

Calibration number

Enter the amount of impulses counted while running 1 litre of water through the flow sensor. Use Automatic calibration to calculate impulses automatically. Manual calibration establishes the calibration and limits based on user-entered values. Range is 10 to 4,900 impulses.

Low flow limit

Enter the flow sensors low limit value. Range is 0 to 99.9 litres/minute.

High flow limit

Enter the flow sensors high limit value. Range is 0 to 999.9 litres/minutes.

Automatic calibration

Automatic calibration establishes the calibration and limits if the number of impulses per litre for the flow meter is unknown or to make sure the value is correct.

Impulse count

Shows the number of impulses during calibration. Minimum of 10 impulses needed to do a calibration.

Collected volume

Enter the volume passed through the flow sensor during the calibration. Once encoded, a new flow sensor calibration value is calculated. Range is 0.00 to 9,999.99 litres.

Master switch status / Cancel

Shows if the Master switch is off  or on .

Press the **Cancel** to cancel the calibration and return to the Flow sensor screen.

Flow sensor automatic calibration

1. Press **Calibrate** ❶ to enter automatic calibration mode.
2. Prepare to collect the 'medium' via the Flow sensor (minimum 100 litres).
3. Make sure the controller is in manual mode and flow is not regulated down.
4. Turn on the Master switch ❷ to start flow and calibration.
 - ◀ Impulses counted display during the automatic calibration
5. Once at the minimum 100 litres has distributed, turn off Master switch ❸ to stop calibration.
6. Press the Collected volume value ❹.
7. Enter the precise volume which passed through the flow sensor during the calibration.

Once encoded, a new flow sensor calibration value is calculated.



To cancel the calibration, press **Cancel**, RETURN arrow  or the Home button .

Figure 1-18: Automatic calibration



Liquid pressure sensor

The liquid pressure sensor settings establish the maximum pressure limit and no pressure calibration for the liquid pressure sensor.

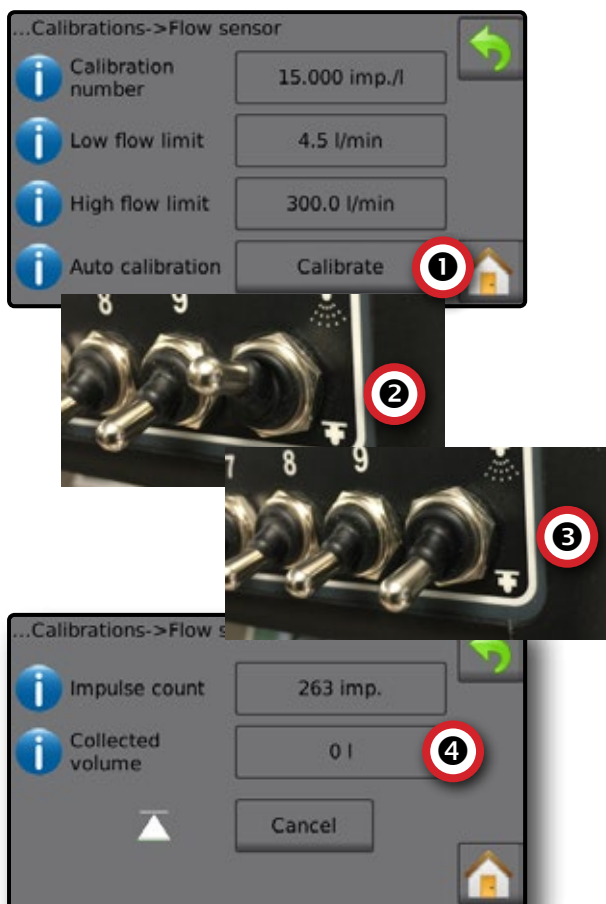

1. From the Home screen, press the SETTINGS button .
2. Press **Machine**.
3. Press **Calibrations**.
4. Press **Liquid pressure sensor**.
5. Calibrate each option in the following order:
 - ❶ No pressure
 - ❷ Maximum pressure
6. Press RETURN arrow  to return to the Calibrations screen.

Figure 1-19: Liquid pressure sensor



❶ No pressure

Liquid pressure sensor->No pressure establishes the calibration while **NO** pressure is applied to the liquid pressure sensor.

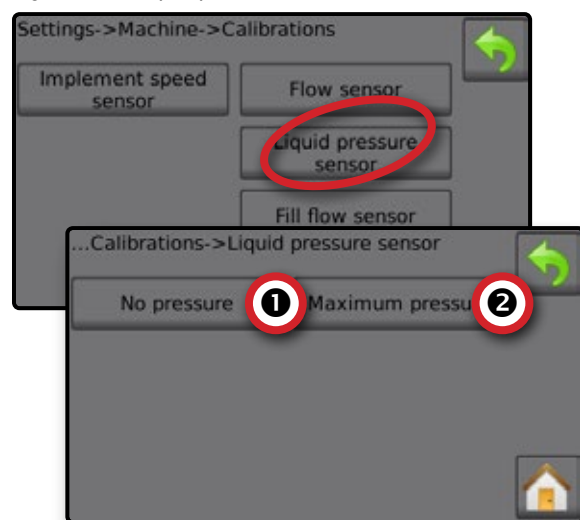
1. Remove all pressure from the system.
2. Press **Calibrate** to record a new calibration value and finalise the calibration.

NOTE: Manual calibration is not available.

Figure 1-20: Liquid pressure sensor->No pressure

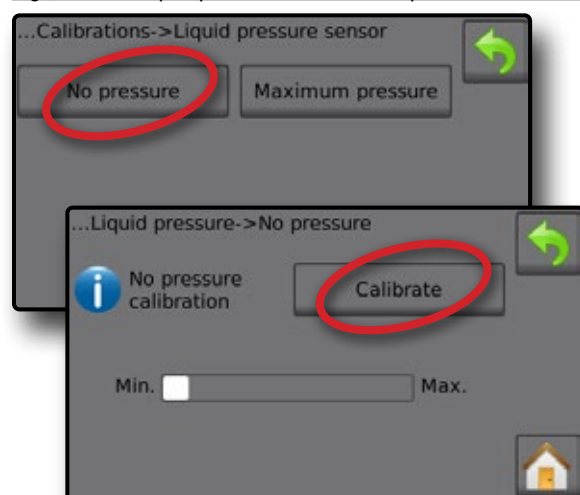

Radion 8140 automatic sprayer control

INTRODUCTION

OPERATION

SETTINGS

DATA

CONSOLE

TOOLS

APPENDIX

② Maximum pressure

Liquid pressure sensor->Maximum pressure establishes the maximum allowed pressure limit for the liquid pressure sensor. The automatic calibration is based on the recommended maximum pressure level and a tested reference pressure level.

Figure 1-21: Liquid pressure sensor->Maximum pressure

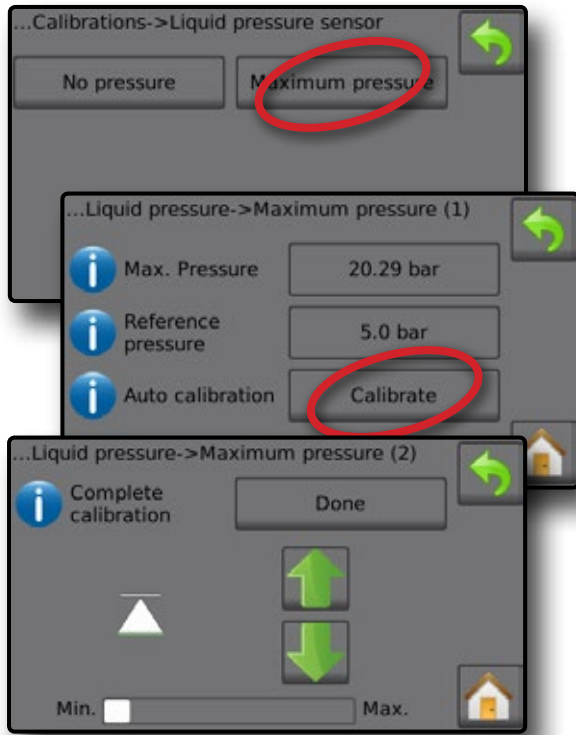

Maximum pressure

Enter the maximum allowed pressure limit for the liquid pressure sensor. Use Automatic calibration to calculate the maximum pressure automatically. Range is 1 to 50 bar.

Reference pressure

Enter the pressure value used as reference for the actual liquid pressure sensor calibration. The reference pressure can be changed, but not while in the calibration mode. Range is 1 to 50 bar.

Automatic calibration

If the maximum pressure is not known, or to make sure the value is correct, automatic calibration establishes the calibration.

Complete calibration

Apply constant reference pressure to the sensor. Press "Done" when complete.

Master switch status / Pressure adjustment

Shows if the Master switch is off  or on .



Press the UP/DOWN arrows   to increase/decrease the pressure until reaching and maintaining the reference pressure.

Minimum/maximum pressure bar

Illustrates the change in pressure from minimum to maximum.

Maximum pressure automatic calibration

IMPORTANT: Make sure all section valves are open before opening the Master valve; otherwise, the pressure could build and damage the system.

1. Press the Reference pressure value ①.
2. Enter the pressure value used as reference for the actual liquid pressure sensor calibration.
3. Press **Calibrate** ② to start an automatic calibration of the sensor.
4. Turn on Master switch ③.
5. Press the UP/DOWN arrows   ④ to increase/decrease the pressure until reaching and maintaining the reference pressure.
6. Apply constant reference pressure to the sensor.
7. Press **Done** ⑤ when complete.
8. Turn off Master switch ⑥ to stop calibration.



To cancel the calibration, press the RETURN arrow  or the Home button .

Figure 1-22: Manual maximum pressure



Maximum pressure manual calibration

1. Press the Maximum pressure value ❶.
2. Enter the maximum allowed pressure limit for the liquid pressure sensor.

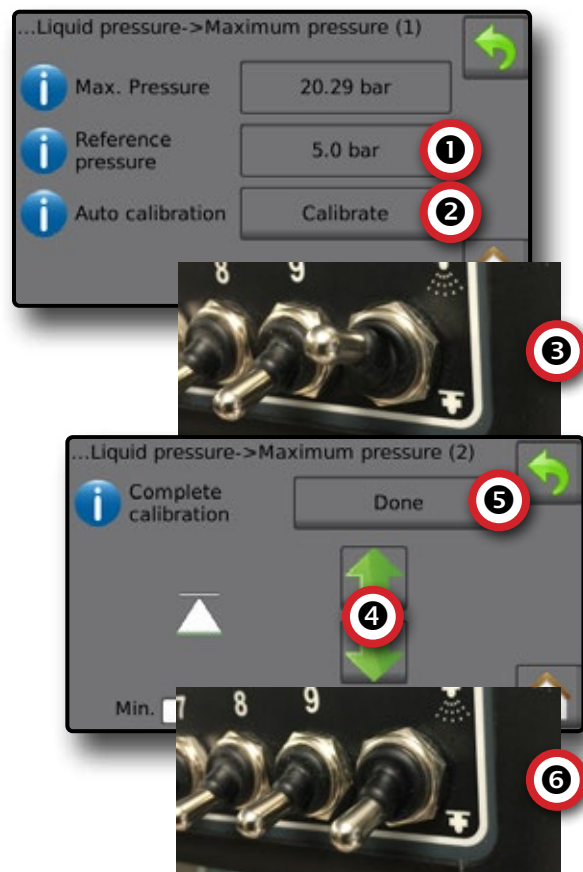
Figure 1-23: Manual maximum pressure

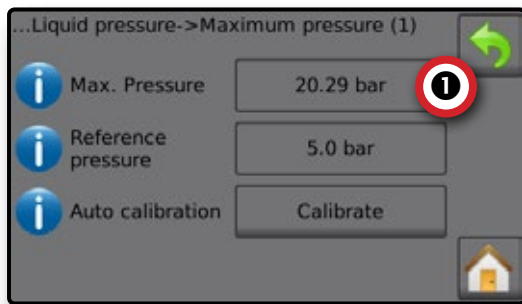

Fill flow sensor

The Fill flow sensor establishes the impulses per litre. The Fill flow value can be established manually or automatically calibrated.

Figure 1-24: Fill flow sensor

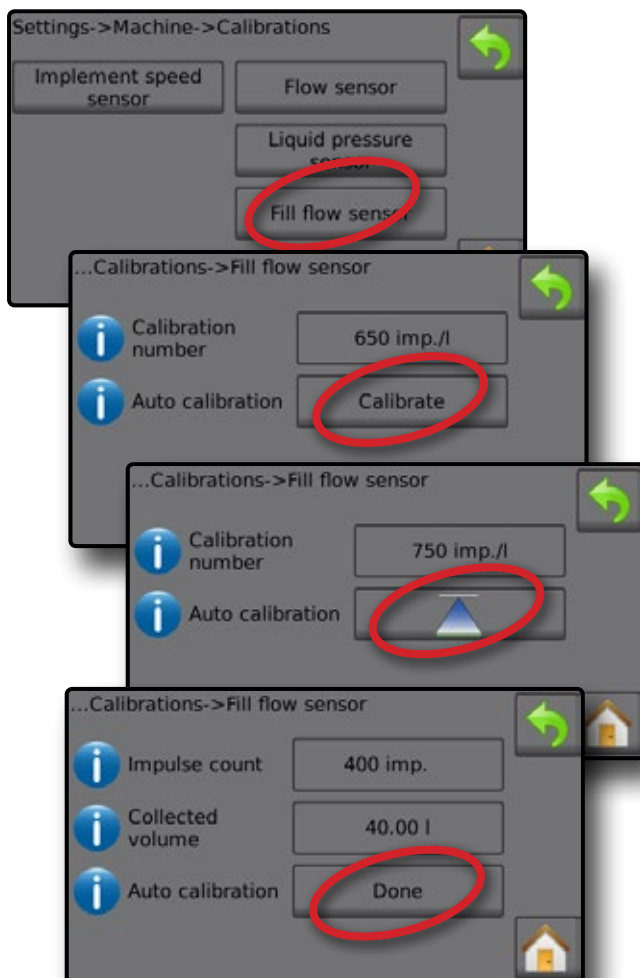

Calibration number

Enter the amount of impulses counted while running one (1) litre of water through the Fill flow sensor. Use Automatic calibration to calculate the impulses automatically. Manual calibration establishes the calibration and limits based on user entered values. Range is 10 to 4,900 impulses.

Automatic calibration

Automatic calibration establishes the calibration if the number of impulses per litre for the Fill flow meter is unknown, or to make sure the value is correct.

Impulse count

The number of impulses calculated during automatic calibration.

Collected volume

Enter the collected volume. Range is 0.00 to 9,999.99 litres.

Automatic calibration done

To complete the automatic calibration, press "Done" when collected volume has been entered.

Fill flow sensor automatic calibration

1. Press **Calibrate** ❶ to enter automatic calibration mode.
2. Prepare to collect the 'medium' via the Fill flow sensor (minimum of 100 litres).
3. Turn on Master switch ❷ to start flow.
4. Press START CALIBRATION button ▲ ❸.
 - ◀ Impulses counted display during automatic calibration
5. Once the desired amount has distributed, press the STOP CALIBRATION button ▾ ❹.
6. Turn off the Master switch ❺.
7. Press the Collected volume value ❻.
8. Enter the precise volume passed through the Fill flow sensor during the calibration.
9. Press **Done** ❼ to complete the automatic calibration.

To cancel the calibration, press RETURN arrow ↩ or the Home button 🏠.

Radion 8140 automatic sprayer control

Figure 1-25: Fill flow sensor automatic calibration

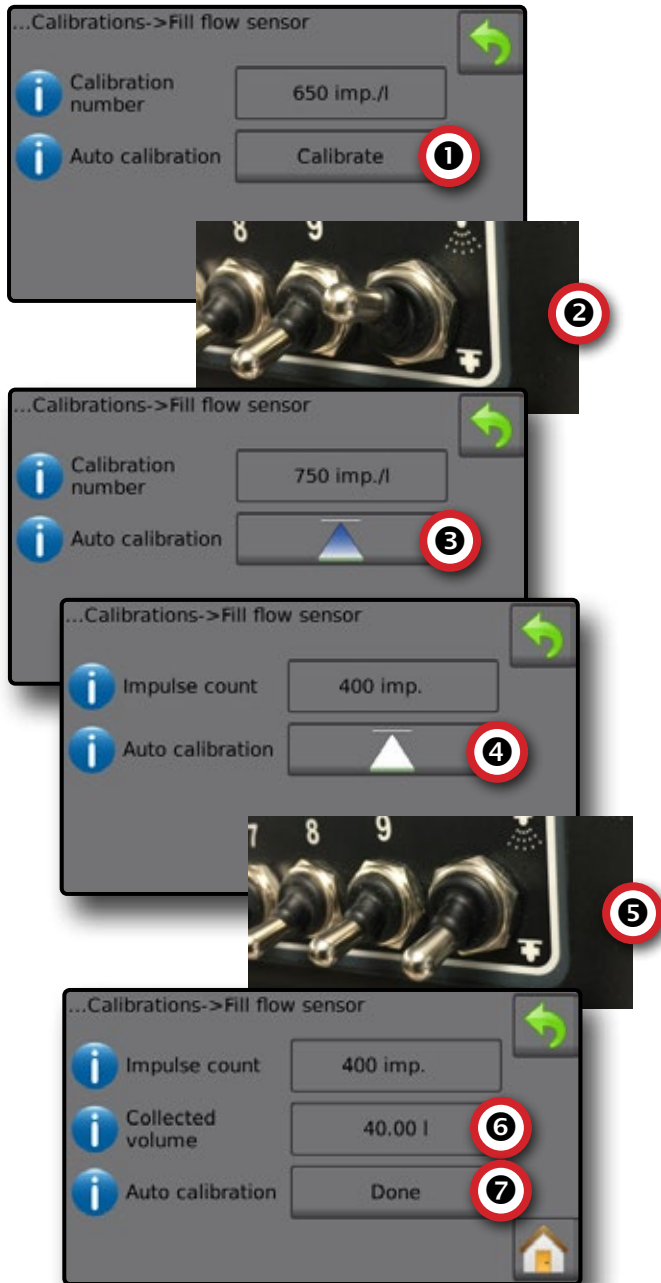

Tank level sensor

Tank level sensor establishes the empty, minimum and maximum levels for the tank and calibrates the tank shape. Tank level sensor calibration settings can be exported to a USB drive and recalled for future use.

NOTE: Manual calibration is not available for any Tank level sensor calibrations.

1. From the Home screen, press the SETTINGS button .
2. Press **Machine**.
3. Press **Calibrations**.
4. Press **Tank level sensor**.
5. Calibrate each option in the following order:
 - ❶ Empty tank
 - ❷ Minimum tank level
 - ❸ Maximum tank level
 - ❹ Tank shape

6. Press RETURN arrow  to return to the Calibrations screen.

Figure 1-26: Tank level sensor



❶ Empty tank – Automatic calibration

Empty tank establishes the empty tank value.

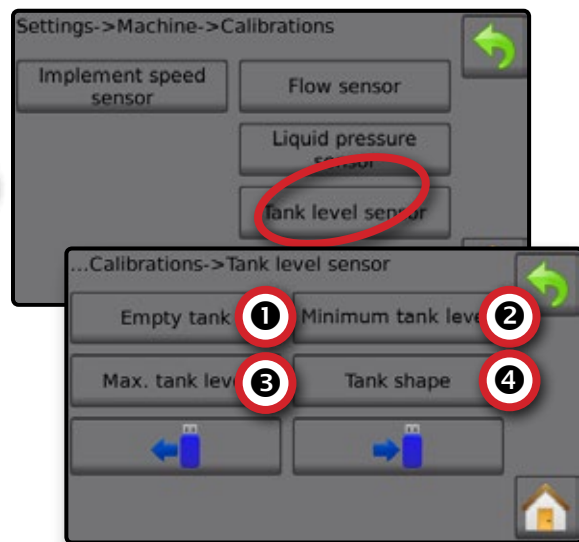
Figure 1-27: Empty tank

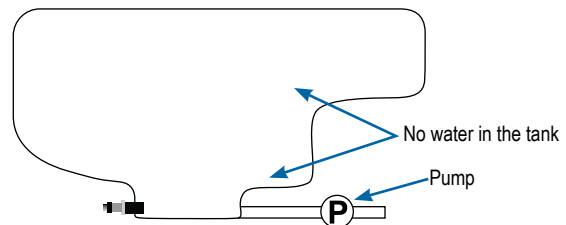

IMPORTANT: The tank should be completely empty.

1. Press **Calibrate** to record a new calibration value and finalise the calibration.

◀The low-high graph should be empty

Figure 1-28: Tank level sensor – Empty tank

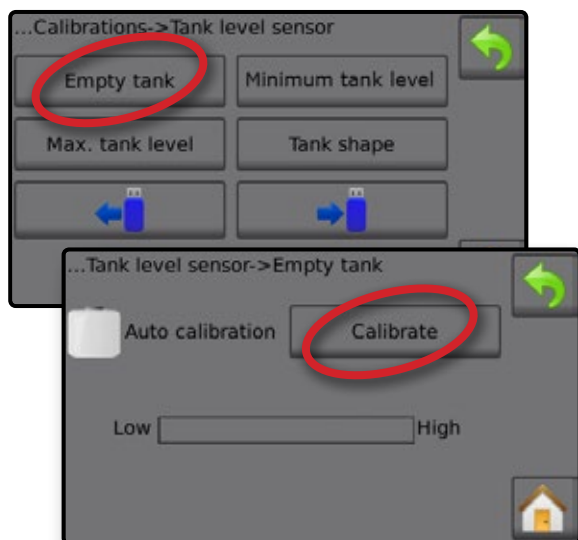

2 Minimum tank level – Automatic calibration

Minimum tank level establishes the minimum level of water on the tank sensor.

Figure 1-29: Minimum tank level

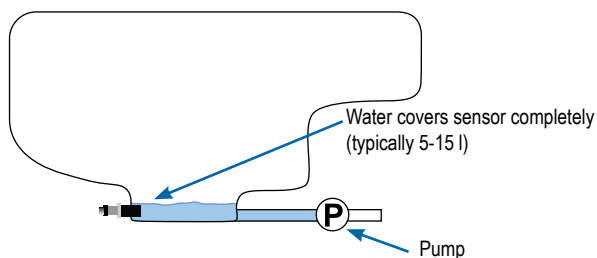

IMPORTANT: Make sure the tank is filled with the contents displayed on the screen. The amount displayed is established in Settings->OEM->Tank setup->Minimum tank content.

1. Press **Calibrate** to record a new calibration value and finalise the calibration.

◀ The low-high graph should display approximately 5% full

Figure 1-30: Tank level sensor – Minimum tank level



3 Maximum tank level – Automatic calibration

Maximum tank level establishes the maximum level of water on the tank sensor.

Figure 1-31: Maximum tank level

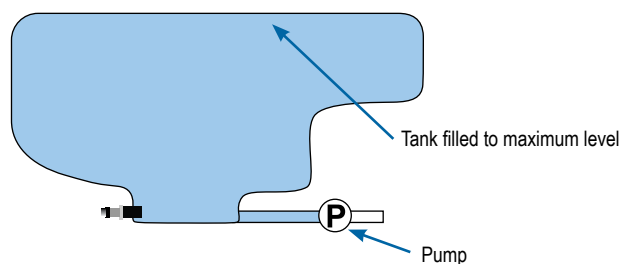

IMPORTANT: Ensure the tank is filled with the contents displayed on the screen. The amount displayed is established in Settings->OEM->Tank setup->Maximum tank content.

1. Press **Calibrate** to record a new calibration value and finalise the calibration.

◀ The low-high graph should display 100% full

Figure 1-32: Tank level sensor – Maximum tank level

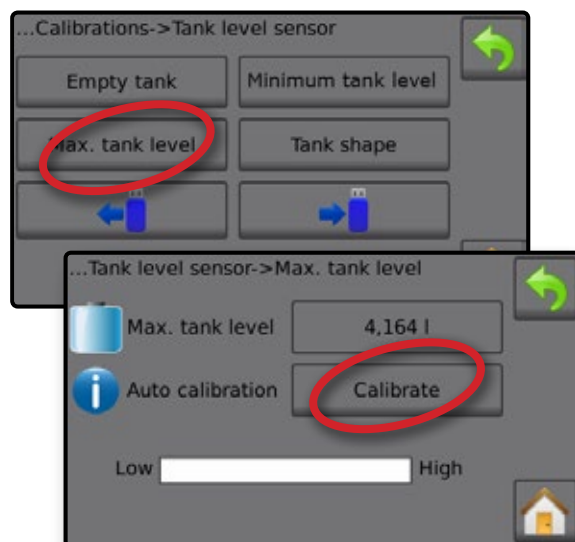

4 Tank shape – Automatic calibration

Tank shape establishes the tank shape.

Figure 1-33: Tank shape calibration

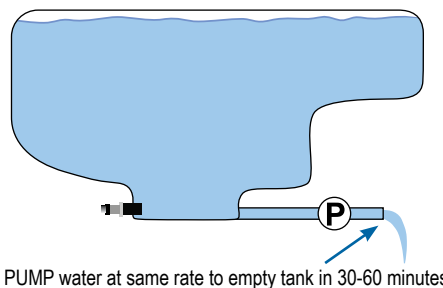

1. Flip Master switch to start calibration.

◀ Tank level sensor graph will go from high to low as the calibration proceeds

Radion 8140 automatic sprayer control

◀ When Calibration progress graph reaches 100%, calibration will record a new calibration value and finalise the calibration

To pause the calibration process, flip the Master switch.

To cancel the calibration, press RETURN arrow ↩ or press the Home button 🏠.

Figure 1-34: Tank level sensor – Tank shape

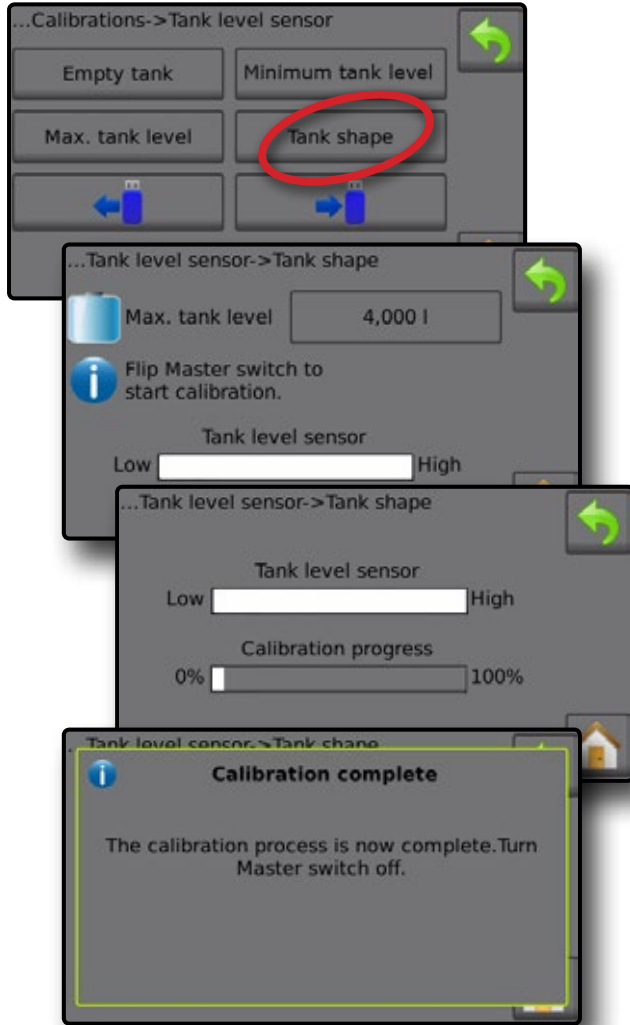

Import / export

Tank level sensor calibration settings can be exported to USB drive and recalled for future use.

NOTE: The import/export buttons ⬅️ ➡️ are not available for selection and are greyed out until a USB drive is inserted properly.

To import the calibration settings:

1. Insert USB drive.
2. Press IMPORT button ⬅️.

To export the calibration settings:

1. Insert USB drive.
2. Press EXPORT button ➡️.

NOTE: Only one (1) tank calibration settings file can be saved on a USB drive at one time. If there is an existing file it will be overwritten.

Figure 1-35: Tank level sensor – Import/export

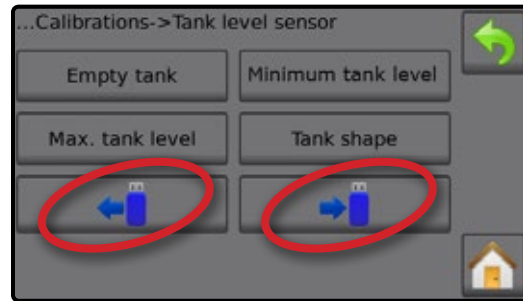

Alarms

Alarms establishes alarms as on/off, or sets their trigger level.

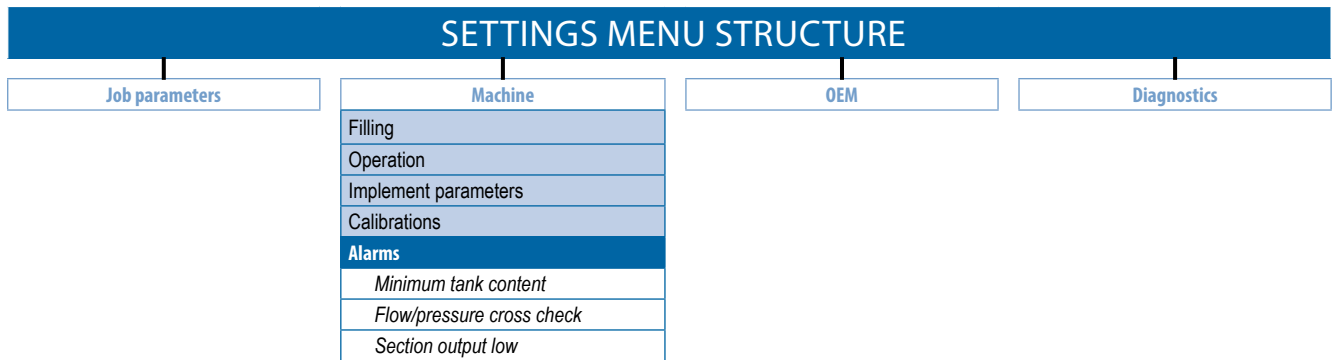



1. From the Home screen, press the SETTINGS button .
2. Press **Machine**.
3. Press **Alarms**.
4. Press setting value to adjust settings as needed:
 - ◀ Minimum tank content
 - ◀ Flow/pressure cross check (alarm active only when both a Flow sensor and Liquid pressure sensor are active)
 - ◀ Section output low
5. Press RETURN arrow  to return to the Machine screen.

Figure 1-36: Alarms



Minimum tank content

Minimum tank content alarm establishes the minimum volume level at which an alarm will sound. Range is dependent of Maximum.

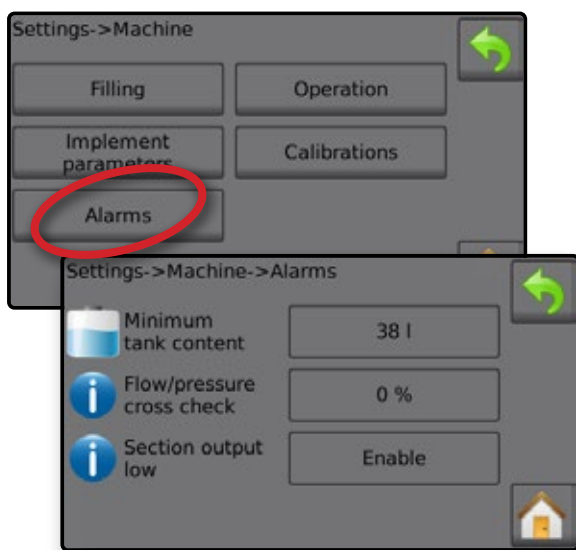
Flow/pressure cross check

Flow/pressure cross check alarm establishes at what percentage the associated alarm will sound.

Section output low

Section output low alarm establishes if the alarm will sound if a section is turned on, yet no load is sensed from that section.

Active alarms on Operation screen

Active Alarm warnings will appear on the Operation screen.

Figure 1-37: Alarm warning on the operations screen

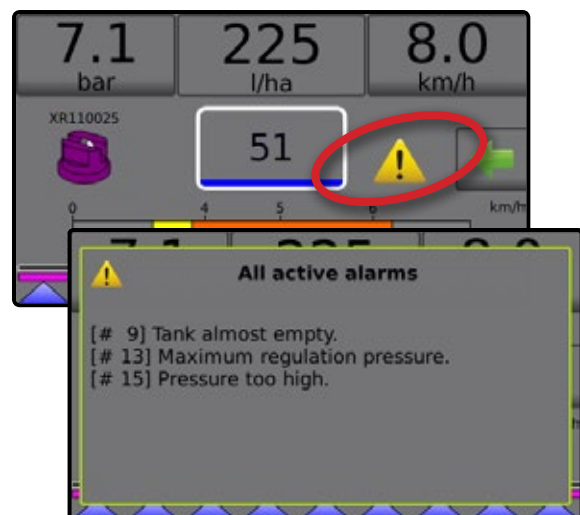

NOTE: For a list of Alarm message codes see the Appendix C – Alarm configurations.

Radion 8140 automatic sprayer control

INTRODUCTION

OPERATION

SETTINGS

DATA

CONSOLE

TOOLS



APPENDIX

OEM

The OEM menu is password protected and the settings in this menu directly relate to the fitted OEM equipment. Once the OEM menu is unlocked, it will remain unlocked until the Radion 8140 is powered off. To access the OEM screens, follow the steps below.

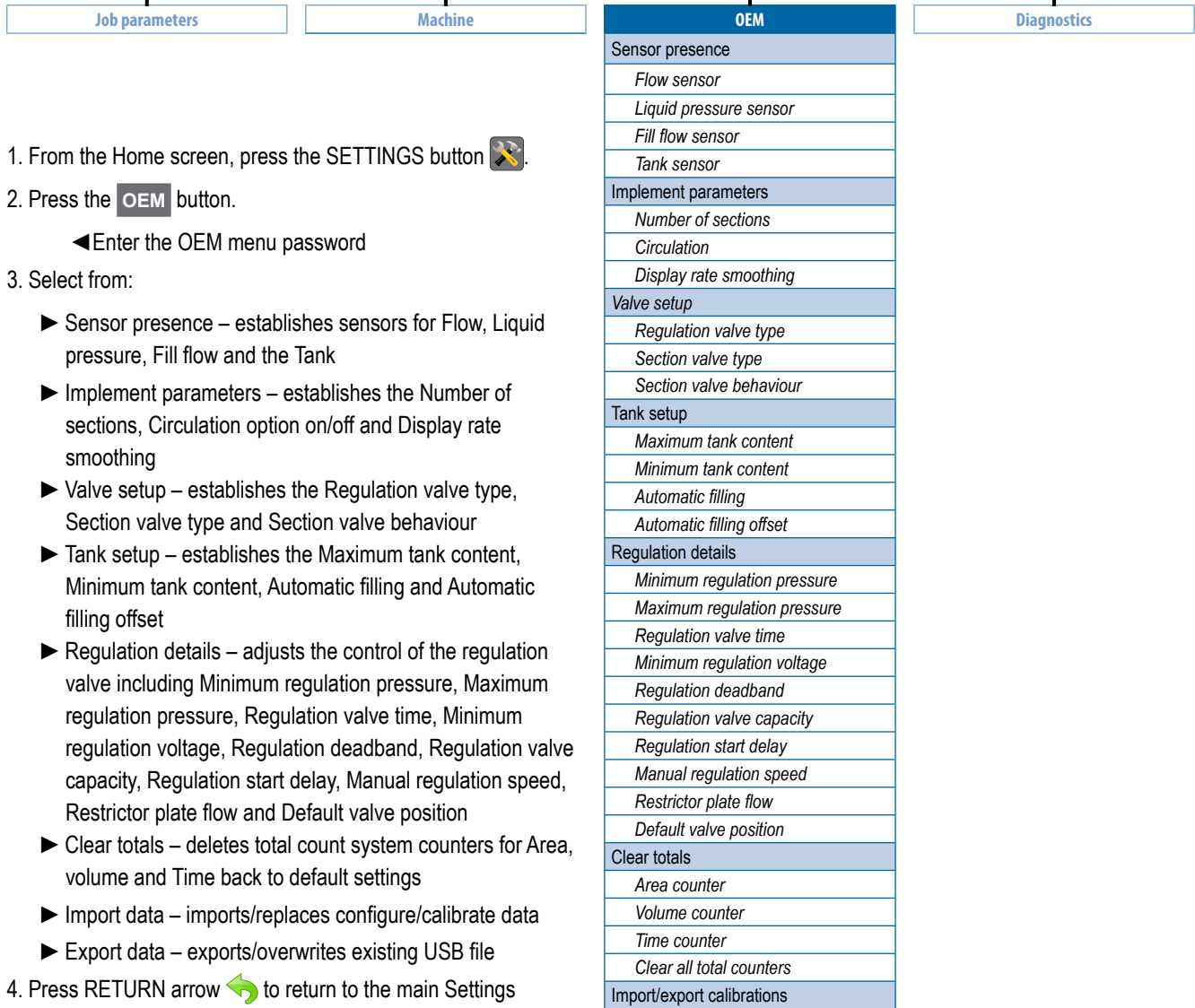
SETTINGS MENU STRUCTURE



- From the Home screen, press the SETTINGS button .
- Press the **OEM** button.
 - ◀ Enter the OEM menu password
- Select from:
 - ▶ Sensor presence – establishes sensors for Flow, Liquid pressure, Fill flow and the Tank
 - ▶ Implement parameters – establishes the Number of sections, Circulation option on/off and Display rate smoothing
 - ▶ Valve setup – establishes the Regulation valve type, Section valve type and Section valve behaviour
 - ▶ Tank setup – establishes the Maximum tank content, Minimum tank content, Automatic filling and Automatic filling offset
 - ▶ Regulation details – adjusts the control of the regulation valve including Minimum regulation pressure, Maximum regulation pressure, Regulation valve time, Minimum regulation voltage, Regulation deadband, Regulation valve capacity, Regulation start delay, Manual regulation speed, Restrictor plate flow and Default valve position
 - ▶ Clear totals – deletes total count system counters for Area, volume and Time back to default settings
 - ▶ Import data – imports/replaces configure/calibrate data
 - ▶ Export data – exports/overwrites existing USB file
- Press RETURN arrow  to return to the main Settings screen.

OEM menu is password protected.

Figure 1-38: Settings options

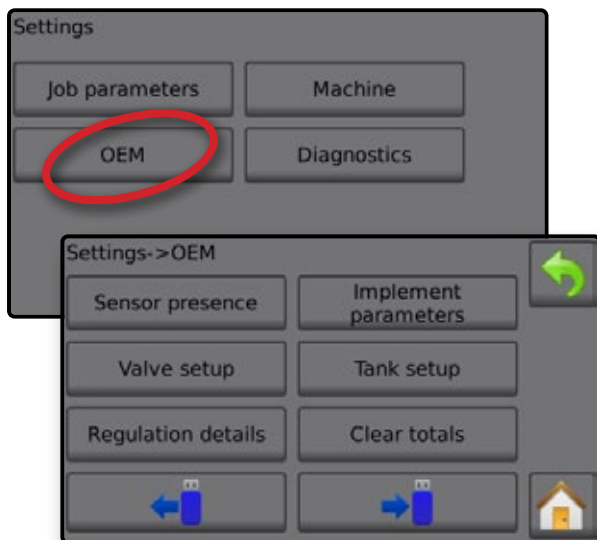

Sensor presence

Sensor Presence establishes sensors for Flow, Liquid Pressure, Fill Flow and the Tank. If the fitted sensors are not registered, the sensor options will not be available in the calibration menus.

Options established here affect the following settings:

- ▶ Settings->Machine->Filling
- ▶ Settings->Machine->Calibrations

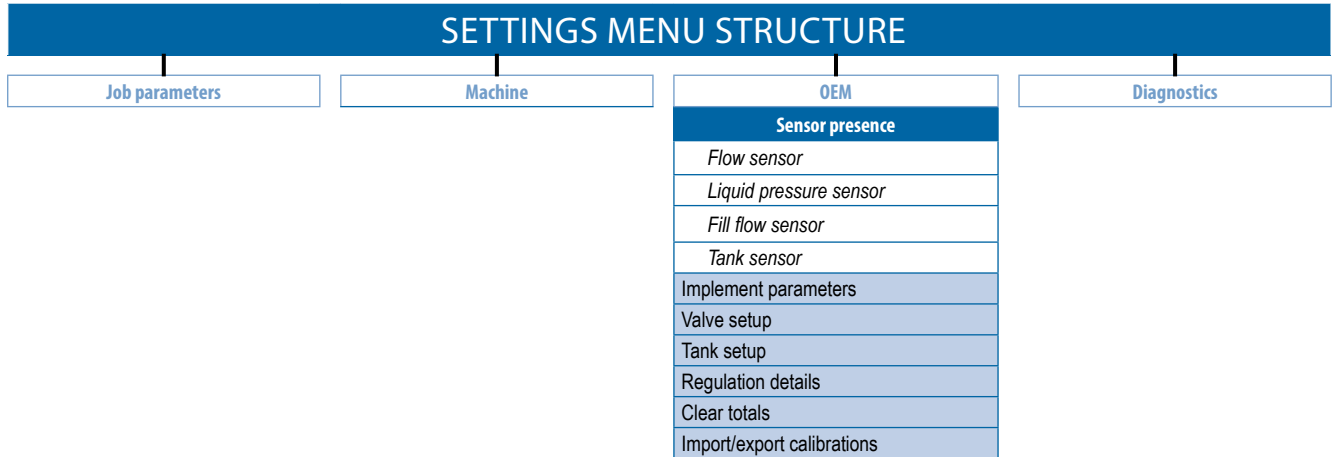



1. From the Home screen, press the SETTINGS button .
2. Press **OEM**.
3. Press **Sensor presence**.
4. Press setting value to adjust settings as needed:
 - ◀Flow sensor
 - ◀Liquid pressure sensor
 - ◀Fill flow sensor
 - ◀Tank sensor
5. Press RETURN arrow  to return to the OEM screen.

Figure 1-39: Sensor presence screen



Flow sensor

Flow sensor is a digital sensor for measuring liquid flow. Flow sensor sets the associated sensor availability.

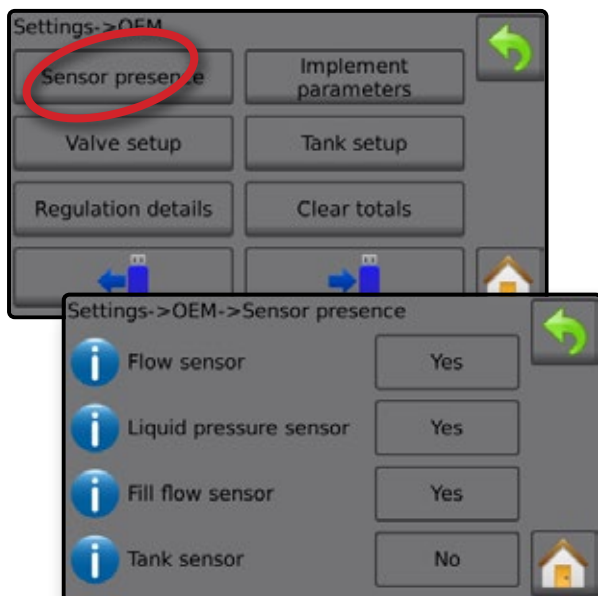
Liquid pressure sensor

Liquid pressure sensor is an analogue sensor for measuring pressure. Liquid pressure sensor sets the associated sensor availability.

Fill flow sensor

Fill flow sensor is a digital sensor for measuring flow. Fill flow sensor sets the associated sensor availability.

Tank sensor

Tank sensor is an analogue sensor for measuring tank content. Tank sensor sets the associated sensor availability.

Radion 8140 automatic sprayer control

INTRODUCTION

OPERATION

SETTINGS

DATA

CONSOLE

TOOLS

APPENDIX

Implement parameters

Implement parameters establishes the Number of sections, Circulation and Display rate smoothing. These settings are by the system to configure the target rate.

Options established here affect the following settings:

- Settings->Machine->Implement parameters->Section configuration

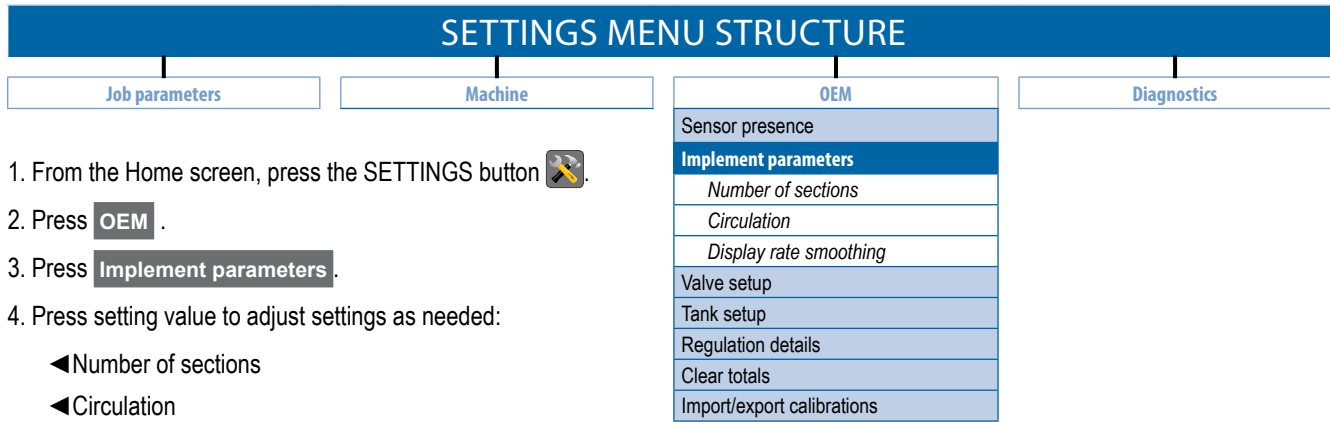

1. From the Home screen, press the SETTINGS button
2. Press **OEM**.
3. Press **Implement parameters**.
4. Press setting value to adjust settings as needed:
 - ◀ Number of sections
 - ◀ Circulation
 - ◀ Display rate smoothing
5. Press RETURN arrow to return to the OEM screen.

Figure 1-40: Implement parameters screen

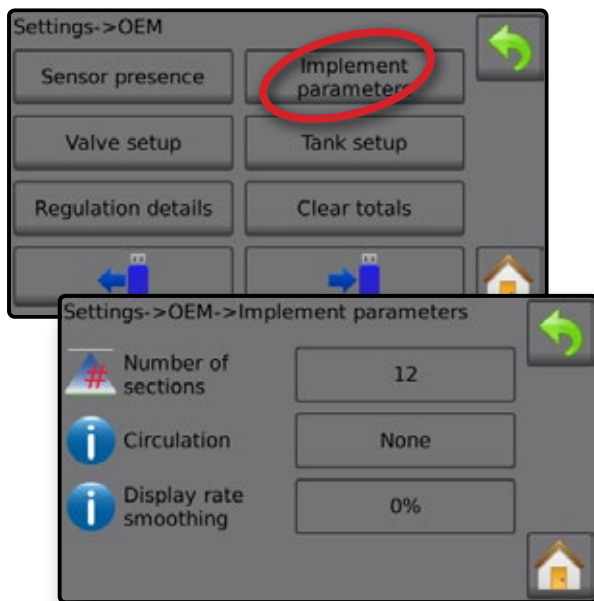

Number of sections

Number of sections establishes how many sections are on the implement. Range is 1 to 13, depending on console availability. Nine (9) switch consoles are capable of supporting up to 13 boom sections. The boom sections are paired across the nine (9) switches but will work as individual sections in ASC mode. Contact TeeJet Support for more information.

NOTE: Although the Number of sections range is 1 to 13, the max. number of physical switches are still nine (9). See the "Boom section & switches" section of this manual for more information.

NOTE: The target rate is based upon the active boom width. The boom width is calculated from referencing the number of sections, the number of nozzles per section, and the space between the nozzles. Console operation is based upon the active width so the active sections will determine the width the controller will target.

Circulation

Circulation establishes if flow in the boom is increased to help keep product suspended in the system. Based on the Restrictor Plate value, the circulation flow will be subtracted from the measured flow so that the console knows exactly what is sprayed or returned to the tank.

- ◀ None – no circulation
- ◀ Semi – part of each section continuously circulates back to the tank as long as both the section and Master Switch is on.
- ◀ Full – additional flow continuously circulates back to the tank as long as the Master Switch is on

Display rate smoothing

Display rate smoothing is a percent value used as a deadband for displaying the application rate valve on the operation screen. Range is 0 to 25%.

NOTE: Once actual application rate is within the percent deadband value of the target rate, target rate will be shown.

Sections on Operation screen

The number of sections established will be shown on the Operation screen.

Figure 1-41: Operation screen with 9 or 6 sections

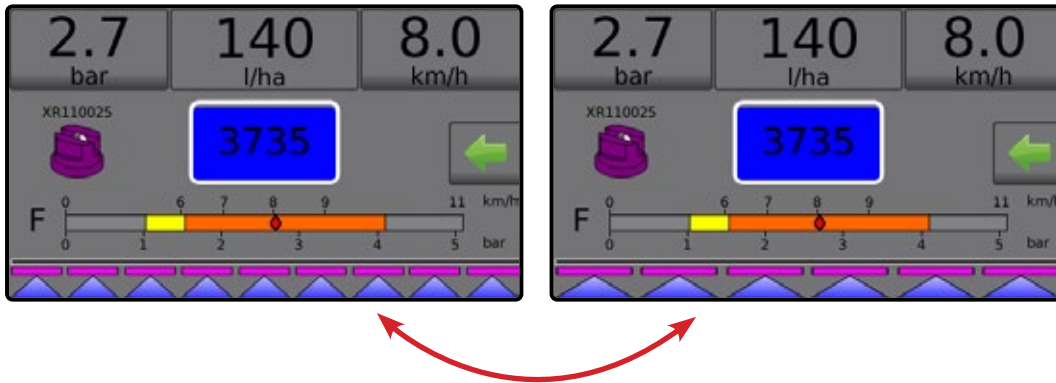

Valve setup

The Valve setup establishes the Regulation valve type, Section valve type and Section valve behaviour.

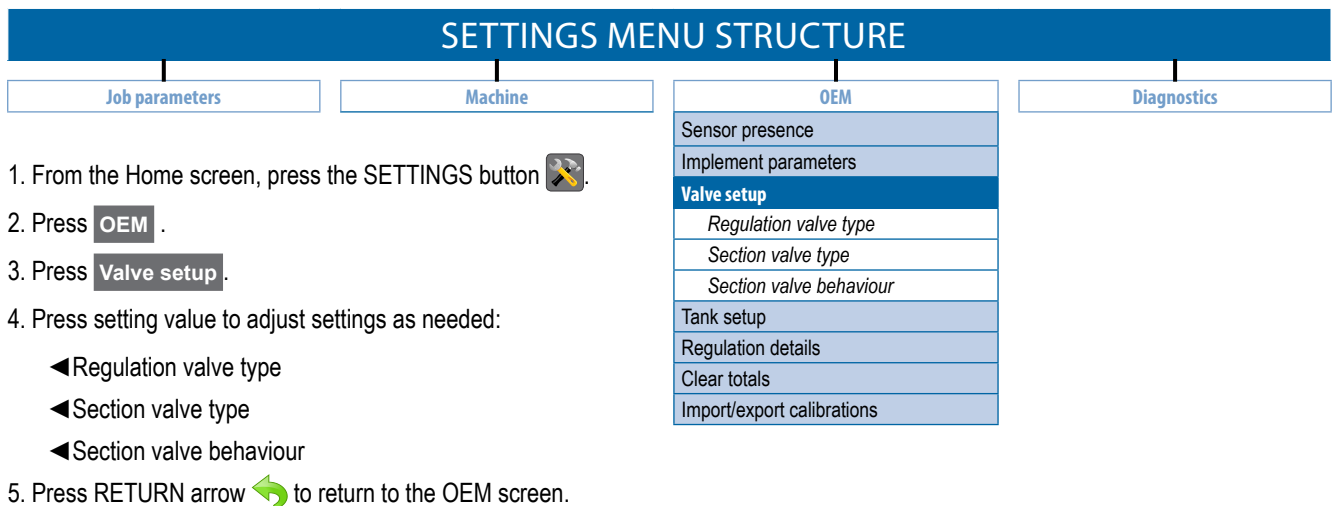
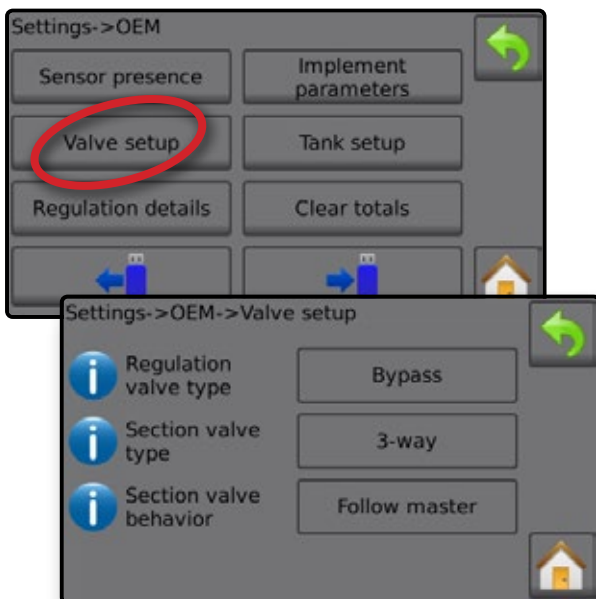

Figure 1-42: Valve setup screen



Regulation valve type

Regulation valve type sets the valve type to either "Throttle" or "Bypass". Throttle is also known as "In-line".

Section valve type

Section valve type sets the valve to either "2-way" or "3-way".

Section valve behaviour

Section valve behaviour establishes if the sections are powered independently of the master switch or if the sections are powered to follow the master switch.

Radion 8140 automatic sprayer control

INTRODUCTION

OPERATION

SETTINGS

DATA

CONSOLE

TOOLS

APPENDIX



Tank setup

Tank setup establishes the maximum and minimum tank content, Auto filling mode and Auto filling offset value.

Options established here affect the following settings:

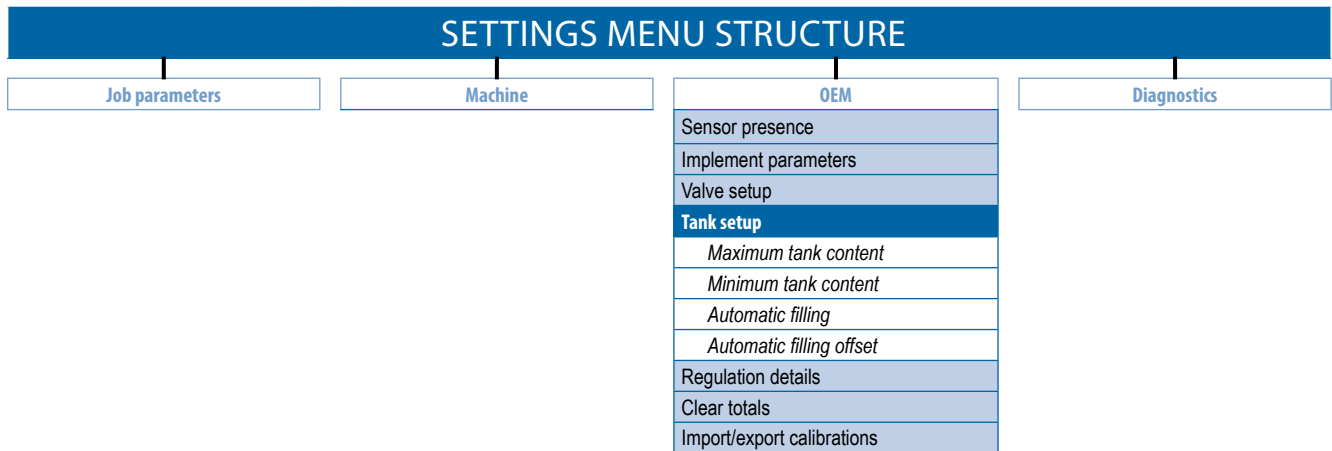
- ▶ Settings->Machine->Filling->Full tank
- ▶ Settings->Machine->Calibrations->Tank sensor



1. From the Home screen, press the SETTINGS button .
2. Press **OEM**.
3. Press **Tank setup**.
4. Press setting value to adjust settings as needed:
 - ◀ Maximum tank content
 - ◀ Minimum tank content
 - ◀ Automatic filling
 - ◀ Automatic filling offset
5. Press RETURN arrow  to return to the OEM screen.

Maximum tank content

Maximum tank content establishes the maximum possible tank volume is entered. Range is 0 to 65,000 litres.

Minimum tank content

Minimum tank content establishes the minimum tank volume agitation should automatically be shut off. Range is 0 to 1,000 litres.

Automatic filling

Automatic filling sets automatic filling mode.

Automatic filling offset

Automatic filling offset establishes the volume that will continue to run into the tank after the fill valve has started shutting. Range is 0 to 500 litres.

Figure 1-43: Tank setup screen

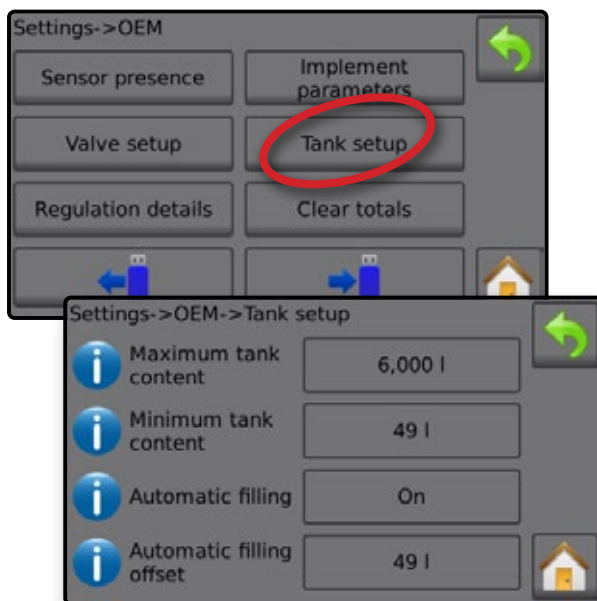

Regulation details

Regulation Details adjusts regulation valve controls including establishing the following: minimum and maximum pressure, valve time, minimum voltage, deadband, valve capacity, start delay, manual speed restrictor plate flow and default valve position.

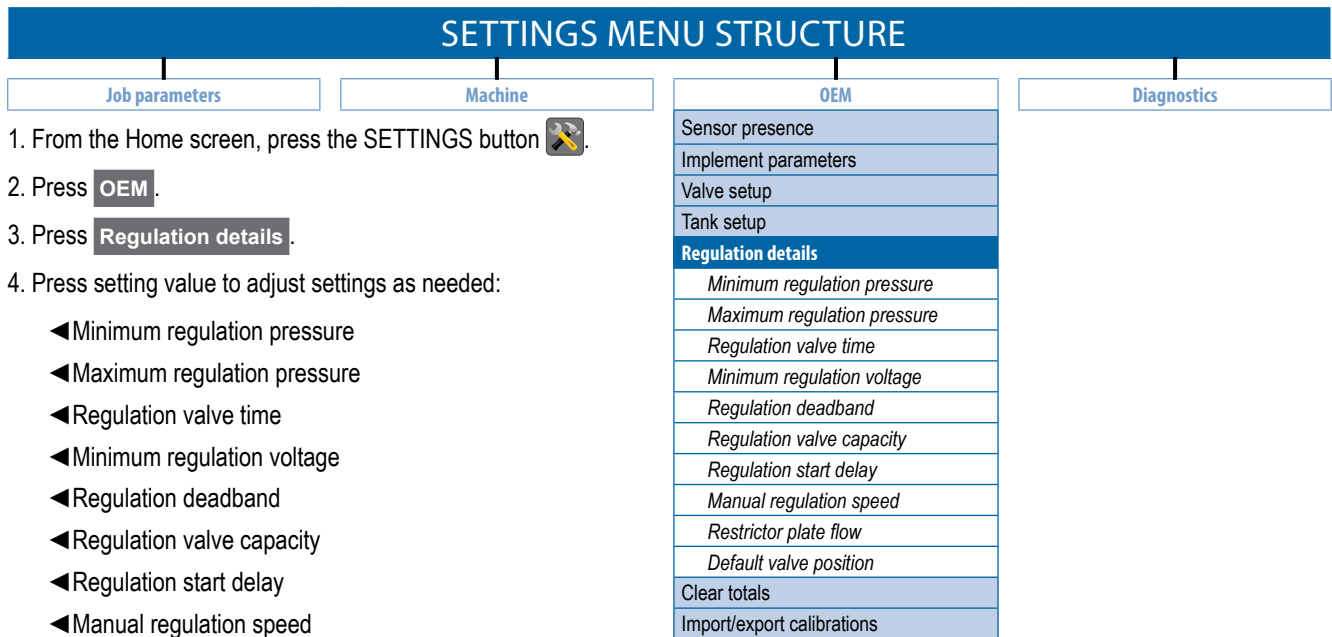

1. From the Home screen, press the SETTINGS button
2. Press **OEM**.
3. Press **Regulation details**.
4. Press setting value to adjust settings as needed:
 - ◀ Minimum regulation pressure
 - ◀ Maximum regulation pressure
 - ◀ Regulation valve time
 - ◀ Minimum regulation voltage
 - ◀ Regulation deadband
 - ◀ Regulation valve capacity
 - ◀ Regulation start delay
 - ◀ Manual regulation speed
 - ◀ Restrictor plate flow
 - ◀ Default valve position
5. Press RETURN arrow to return to the OEM screen.

Figure 1-44: Regulation details screen

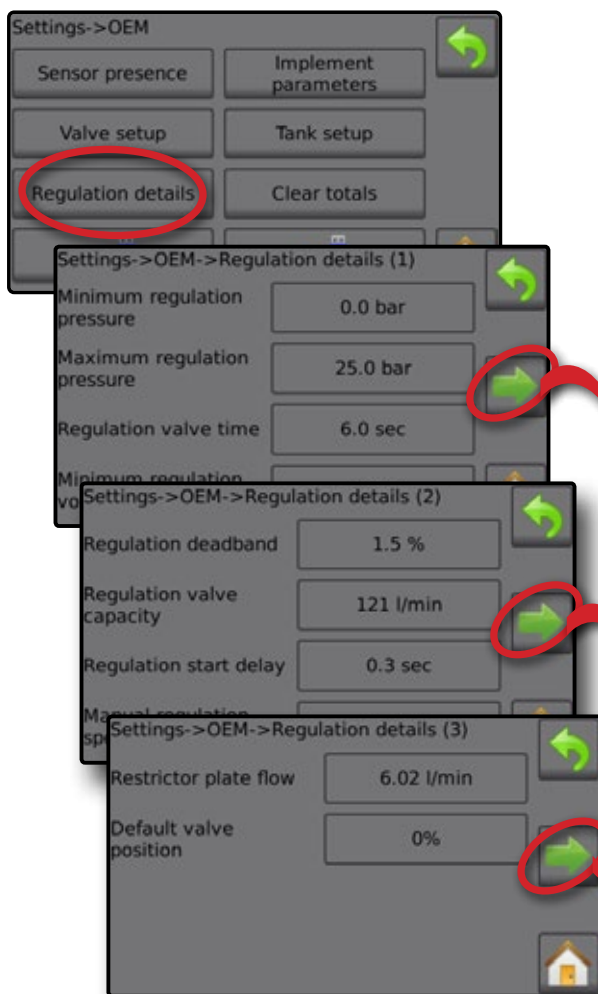

Screen (1)

Minimum regulation pressure

Minimum regulation pressure establishes the level that the working pressure will not drop below, even if a lower pressure is required by the regulation system (the controller). If the actual pressure on the sprayer becomes lower than this value, the regulating system will continue to increase the pressure until the minimum pressure level has been reached. Range is 0.0 to 2.0 bar.

Maximum regulation pressure

Maximum regulation pressure establishes the level that the working pressure will not rise higher than, even if a higher pressure can be obtained by the regulation system (the controller). If the actual pressure on the sprayer becomes higher than this value, the regulating system will continue to decrease the pressure until the maximum pressure has been reached. Range is 0.0 to 50.0 bar.

Regulation valve time

Regulation valve time is the time in seconds for the regulation valve to go from fully closed to fully open (or vice versa). Range is 1.0 to 60.0 seconds.

NOTE: The time is determined by the type of regulation valve used and should be set to the recommendations included with the regulation valve.

Minimum regulation voltage

Minimum regulation voltage is the lowest voltage at which the regulation valve will start to move. The controller uses variable voltage to control the valve; the closer the actual rate is to the target rate, the lower the voltage sent to the valve will be. The minimum voltage must be found when the valve is under pressure, as this affects the force required to move the valve. Range is 0.0 to 12.0 volts.

Radion 8140 automatic sprayer control

INTRODUCTION

OPERATION

SETTINGS

DATA

CONSOLE

TOOLS

APPENDIX

Screen (2)

Regulation deadband

Regulation deadband establishes an acceptable regulation dead band in percent. Regulation will stop when the difference between the target rate and the actual rate is lower than the entered deadband (percent of the target rate). This is to prevent the valve from oscillating when the actual rate is near the target rate.

Regulation valve capacity

Regulation valve capacity establishes the capacity for the regulation valve. Range is 0 to 999 litres/minute.

Regulation start delay

Regulation start delay is the delay in seconds from when the main valve is switched on until regulation starts. Range is 0.0 to 9.9 seconds.

Clear totals

Clear totals deletes Total Count system counters for Area, Volume and Time and returns all back to default settings.

Clearing totals here also affects the Data->Totals screen.

NOTE: To save current Area, Volume and Time totals before clearing, insert a USB drive and save a CSV file on the Data screen.

Manual regulation speed

Manual regulation speed encodes, in percent of the regulation valve time, the pace at which the regulation valve should move in manual operation.

Screen (3)

Restrictor plate flow

Restrictor plate flow establishes the capacity of the restrictor plate at 2 bar to be used when working with return flow (Circulation). Range is 0.00 to 99.99 l/min.

Default valve position

Default valve position establishes the percentage of the regulation valve activation time. Range is 0 to 100%.

NOTE: 15 minutes after the master switch has been turned off, the valve will completely close then open the the percentage specified.

SETTINGS MENU STRUCTURE

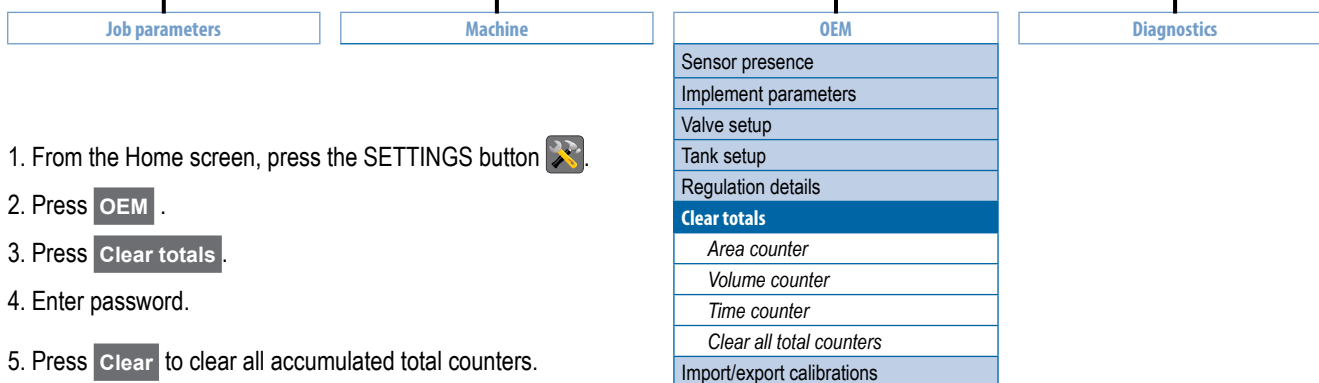

1. From the Home screen, press the SETTINGS button
2. Press **OEM**.
3. Press **Clear totals**.
4. Enter password.
5. Press **Clear** to clear all accumulated total counters.
6. Press RETURN arrow to return to the OEM screen.

Figure 1-45: Clear totals

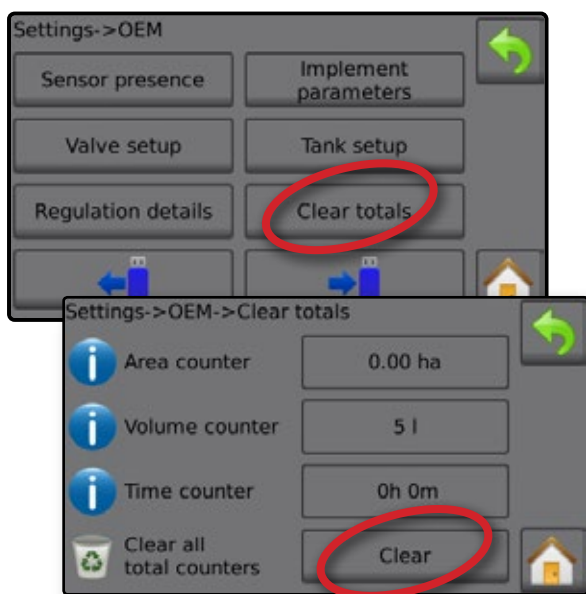

Area counter

Area counter displays total applied area for all jobs.

Volume counter

Volume counter displays total volume of material applied during all jobs.

Time counter

Time counter displays time travelled for all jobs.



Clear all total counters

Press **Clear** to clear all accumulated total counters.

NOTE: Password access for the Clear All Total Counters function is only available from the machine manufacturer and/or TeeJet Technologies.

Import/export data

Configuration and calibration data can be exported to USB drive and recalled for future use.

NOTE: The import/export buttons   are not available for selection and are greyed out until a USB drive is inserted properly.

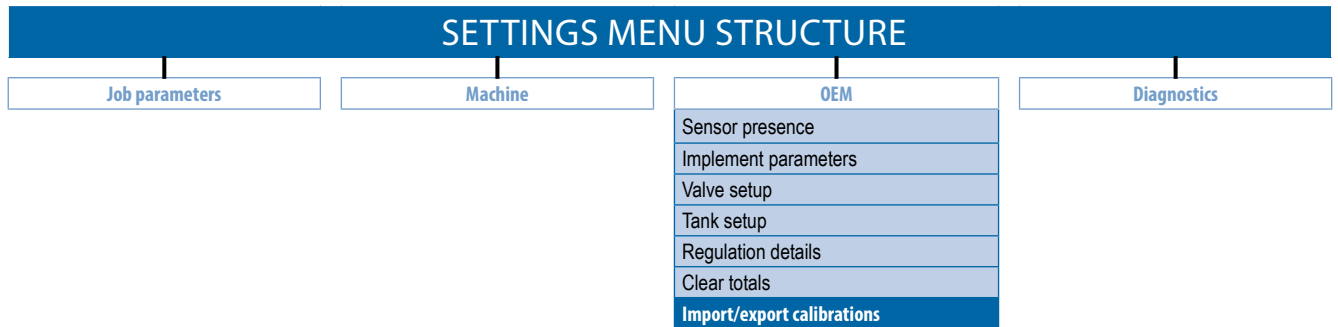

To import the calibration settings:

1. Insert USB drive.
2. Press IMPORT button .

NOTE: Only one (1) tank calibration settings file can be saved on a USB drive at one time. If there is an existing file it will be overwritten.

Figure 1-46: Import data

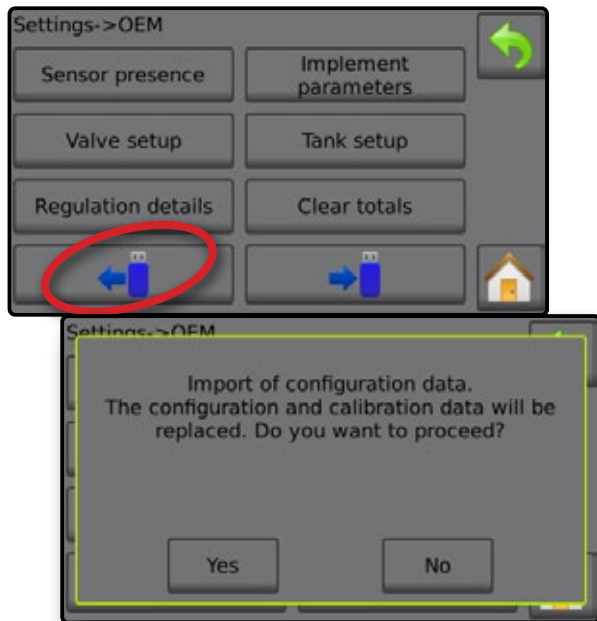

To export the calibration settings:

1. Insert USB drive.
2. Press EXPORT button .

Figure 1-47: Export data



DIAGNOSTICS

Diagnostics troubleshoots input/output of the controller (sensor or actuator).

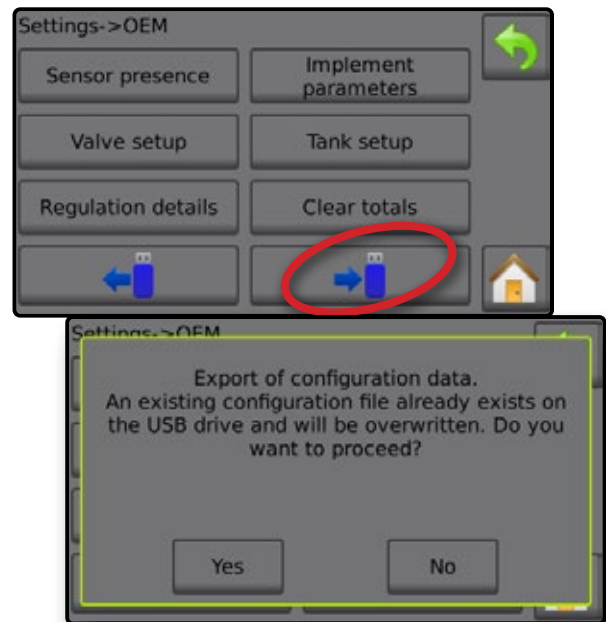
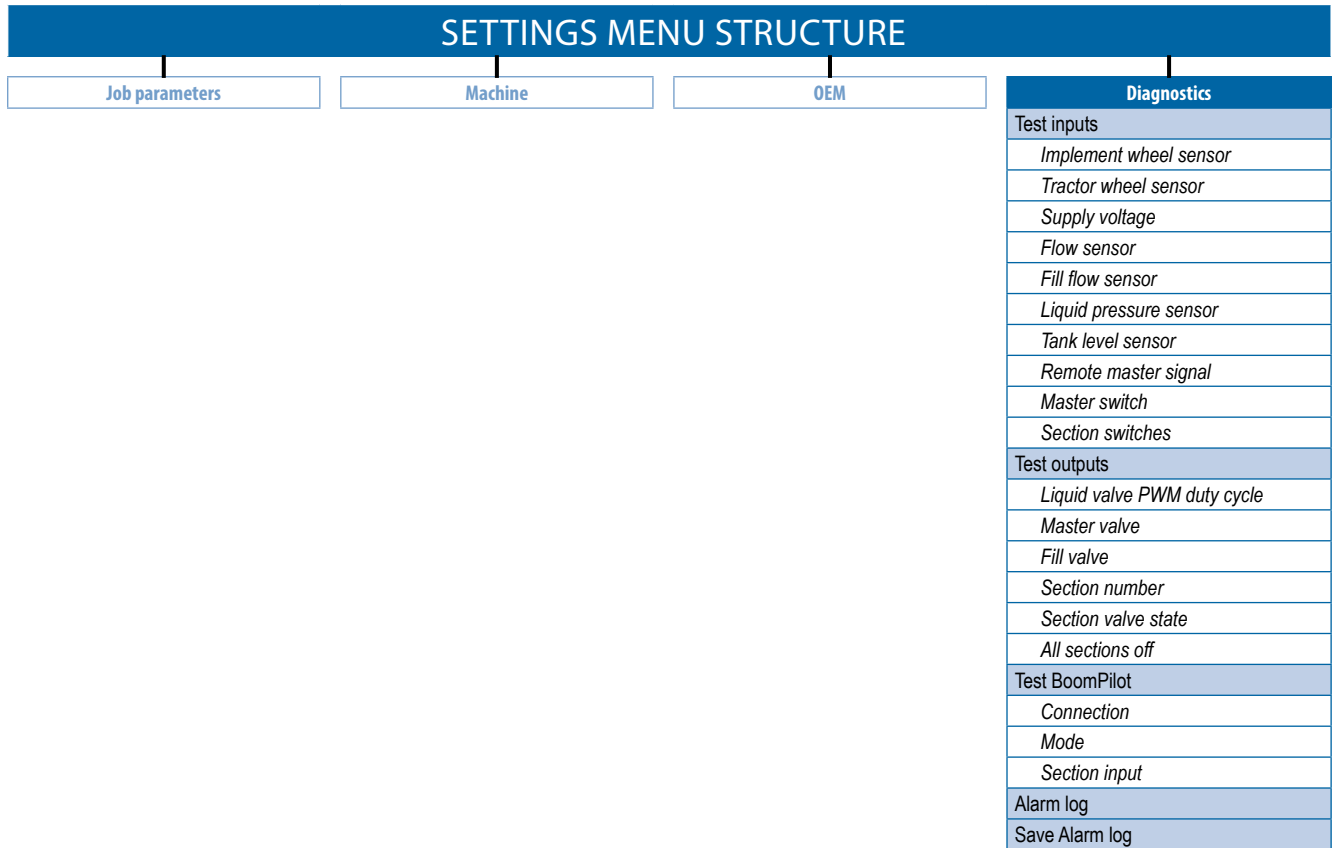



1. From the Home screen, press the SETTINGS button .
2. Press **Diagnostics**.
3. Select from:
 - ▶ Test input – displays the input high and low values on the installed sensors
 - ▶ Test output – sets Liquid valve PWM duty cycle percentage and checks if Master valve, Fill valve and Section valves are on/off
 - ▶ Test BoomPilot – displays automatic boom section control correction, mode and section input status (only available when feature is unlocked)
 - ▶ Alarm log – displays the last 50 alarms
 - ▶ Save alarm log – saves the alarm log
4. Press RETURN arrow  to return to the main Settings screen.

Figure 1-48: Diagnostics



Test inputs

Test inputs displays the input high and low values on the installed sensors. To reset all Test input impulse counts to zero (0), press impulse value.

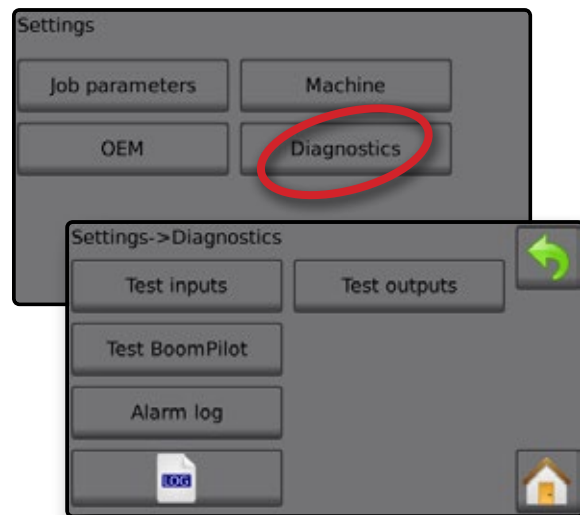
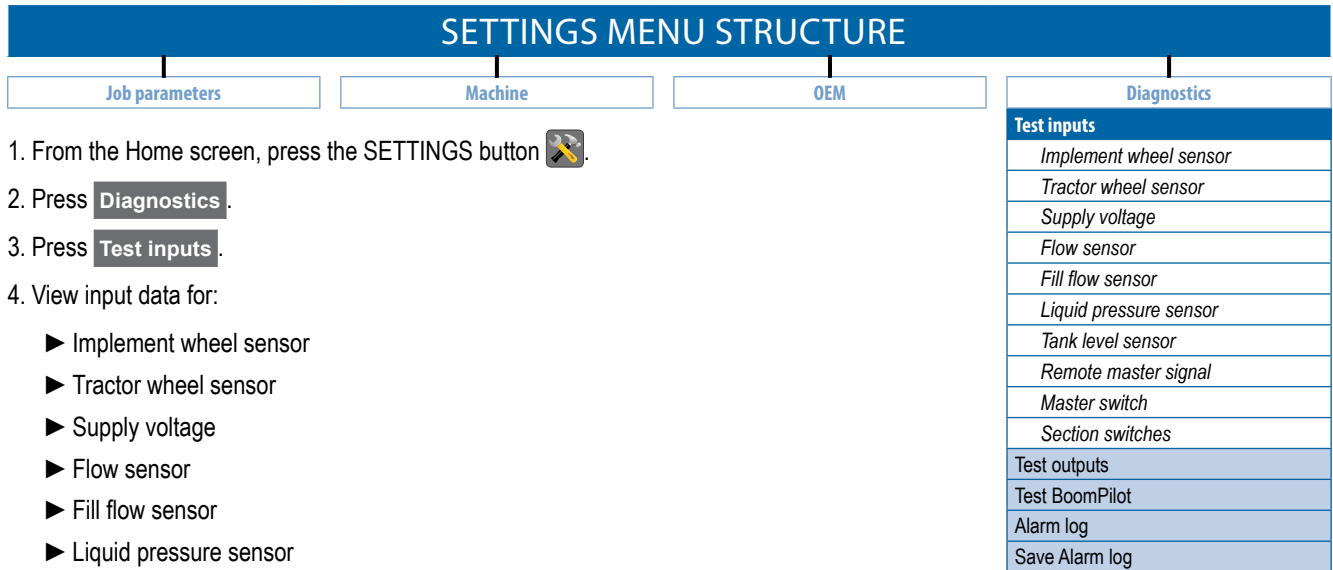

- From the Home screen, press the SETTINGS button
- Press **Diagnostics**.
- Press **Test inputs**.
- View input data for:
 - ▶ Implement wheel sensor
 - ▶ Tractor wheel sensor
 - ▶ Supply voltage
 - ▶ Flow sensor
 - ▶ Fill flow sensor
 - ▶ Liquid pressure sensor
 - ▶ Tank level sensor
 - ▶ Remote master signal
 - ▶ Master switch
 - ▶ Section switches
- Press RETURN arrow to return to the Diagnostics screen.

Figure 1-49: Test inputs

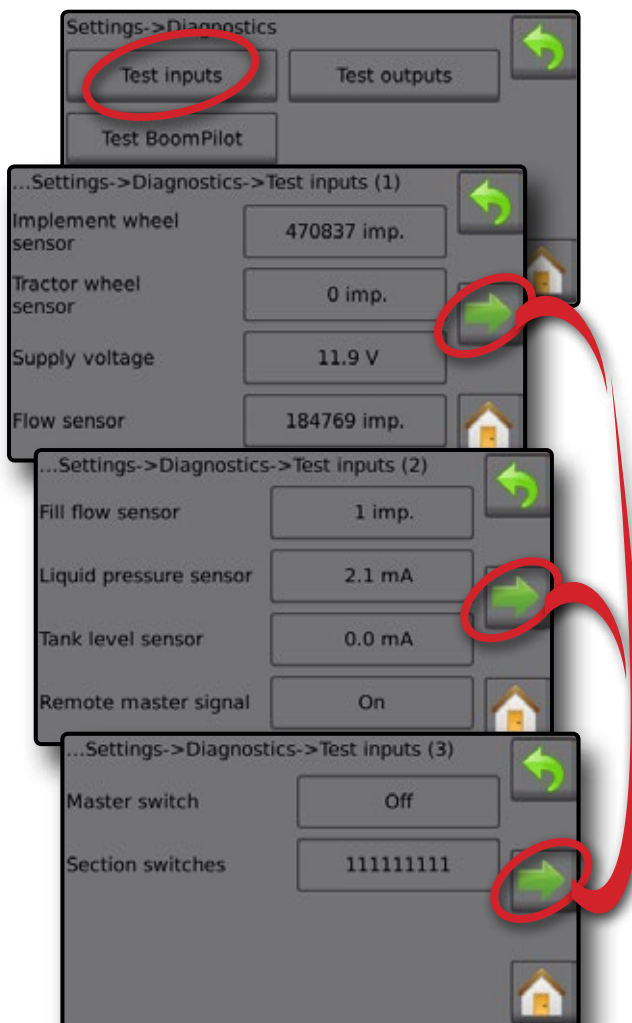

Implement wheel sensor

Test the Implement wheel sensor by activating it and watching the impulse count increase.

Tractor sensor

Test the Radar sensor by activating it and watching the impulse count increase.

Supply voltage

Displays the current given supply voltage.

Flow sensor

Test the Flow sensor by activating it and watching the impulse count increase.

Fill flow sensor

Test the Fill flow sensor by activating it and watching the impulse count increase.

Liquid pressure sensor

Test the Liquid pressure sensor by activating it and watching the value increase/decrease along with the pressure.

Tank level sensor

Test the Tank level sensor by activating it and watching the value increase/decrease along with the tank level.

Remote master signal

Test the Remote master signal by flipping the remote master on/off switch. Watch that the on/off status is reflected on the screen.

Master switch

Test by flipping the Master switch on/off. Watch that the on/off status is reflected on the screen.

Section switches

Test by flipping the section switches on/off. Watch that the on/off status is reflected on the screen.

1 = Section on 0 = Section off

Radion 8140 automatic sprayer control

INTRODUCTION

OPERATION

SETTINGS

DATA

CONSOLE

TOOLS

APPENDIX

Test outputs

Test output sets the Liquid valve PWM duty cycle percentage and checks if the Master valve, Fill valve and Section valves are open or closed.

SETTINGS MENU STRUCTURE

Job parameters	Machine	OEM	Diagnostics
			Test inputs
			Test outputs
			Liquid valve PWM duty cycle
			Master valve
			Fill valve
			Section number
			Section valve state
			All sections off
			Test BoomPilot
			Alarm log
			Save Alarm log



1. From the Home screen, press the SETTINGS button .
2. Press **Diagnostics**.
3. Press **Test outputs**.
4. View output data for:
 - ▶ Liquid valve PWM cycle
 - ▶ Master valve
 - ▶ Fill valve
 - ▶ Section number
 - ▶ Section valve state
 - ▶ All sections off
5. Press RETURN arrow  to return to the Diagnostics screen.

Figure 1-50: Test outputs



Liquid valve PWM duty cycle

Tests the regulation valve at different percentages of duty cycle. 100% equals full speed.

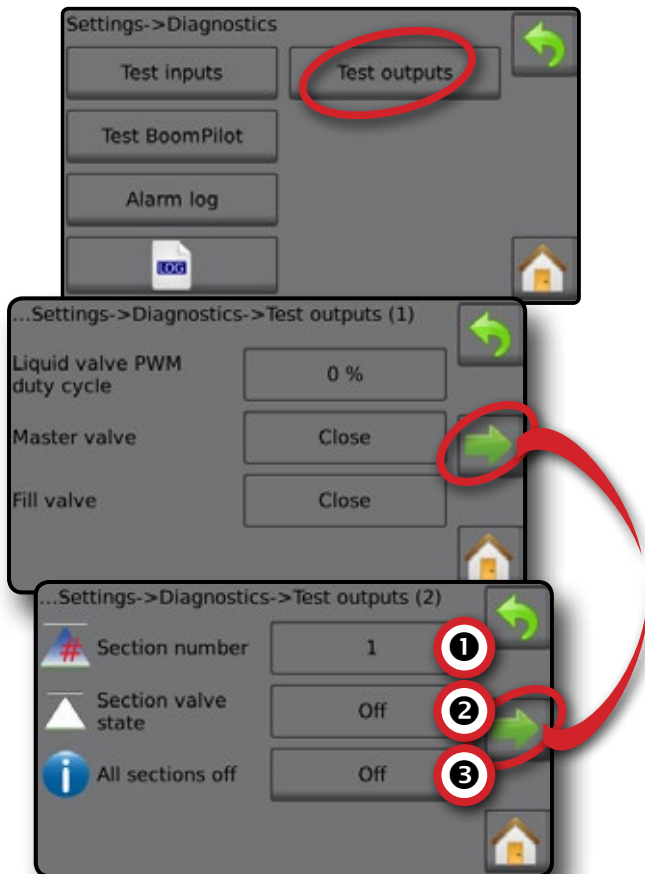
Master Valve

Tests if the master valve is operating correctly. Select if the master valve is open/closed. Verify that the master valve is also open/closed as selected.

Fill Valve

Tests if the fill valve is operating correctly. Select if the fill valve is open/closed. Verify that the fill valve is also open/closed as selected.

Section number

Selects the section number. Sections are numbered from left to right while facing in the forward direction of the machine.

Section valve state

Tests if the section valve is operating correctly. If changing the setting to ON, the valve will open, if changing to OFF the valve will close. Verify that the section valve is also open/closed as selected.

All sections off

Sets all section valves to OFF.

Verify section valve state

1. From the Home screen, press the SETTINGS button .
2. Press **Diagnostics**.
3. Press **Test outputs**.
4. Select Section number **1**.
5. Set the Section valve state **2** for the selected section number.
6. Repeat steps 5 and 6 for additional Section numbers as available.
7. OPTIONAL: To set all section valve states to off, press **Off** **3**.

Test BoomPilot

Test BoomPilot displays the connection, mode and section input status of the automatic boom section control (when installed).

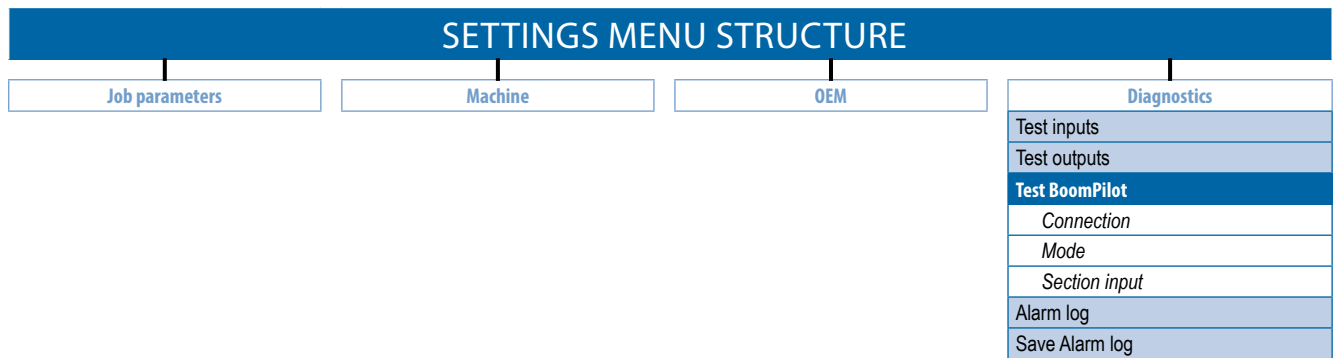



1. From the Home screen, press the SETTINGS button .
2. Press **Diagnostics**.
3. Press **Test BoomPilot**.
4. Select from:
 - ▶ Connection
 - ▶ Mode
 - ▶ Section input
5. Press RETURN arrow  to return to the Diagnostics screen.

Figure 1-51: Test BoomPilot



Connection

Tests if the BoomPilot unit is connected through the CAN bus. When the connection status is NO, check if unit is powered on and cables are properly connected.

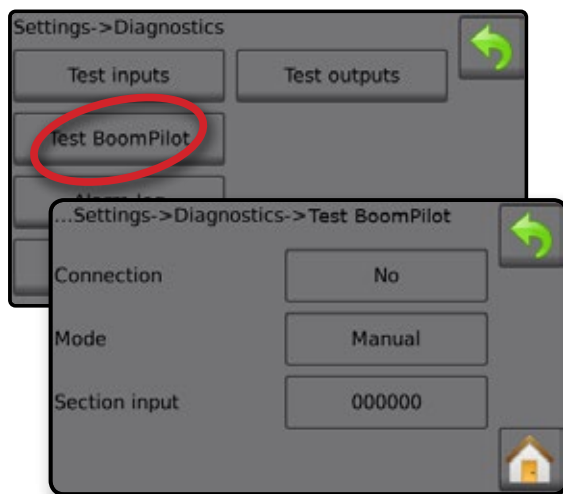
Mode

Tests if the BoomPilot unit is in Automatic or Manual mode. Mode can be changed on the BoomPilot unit.

Section input

Tests if the BoomPilot section input is on/off.

1 = Section on

0 = Section off

Radion 8140 automatic sprayer control

INTRODUCTION

OPERATION

SETTINGS

DATA

CONSOLE

TOOLS

APPENDIX

Alarm log

Alarm log displays the last 50 alarms including how many times the alarm has been set off and the time and date of the last alarm.

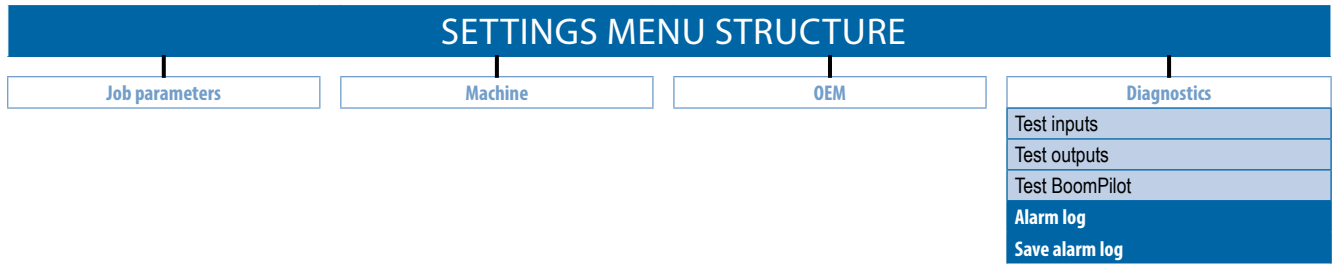



1. From the Home screen, press the SETTINGS button .
2. Press **Diagnostics**.
3. Press **Alarm log**.
4. View data log for:
 - ▶ Alarm ID
 - ▶ Count
 - ▶ Time
 - ▶ Date
5. Press RETURN arrow  to return to the Diagnostics screen.

Figure 1-52: Alarm log



Save alarm log

Saves the alarm log to a USB drive.

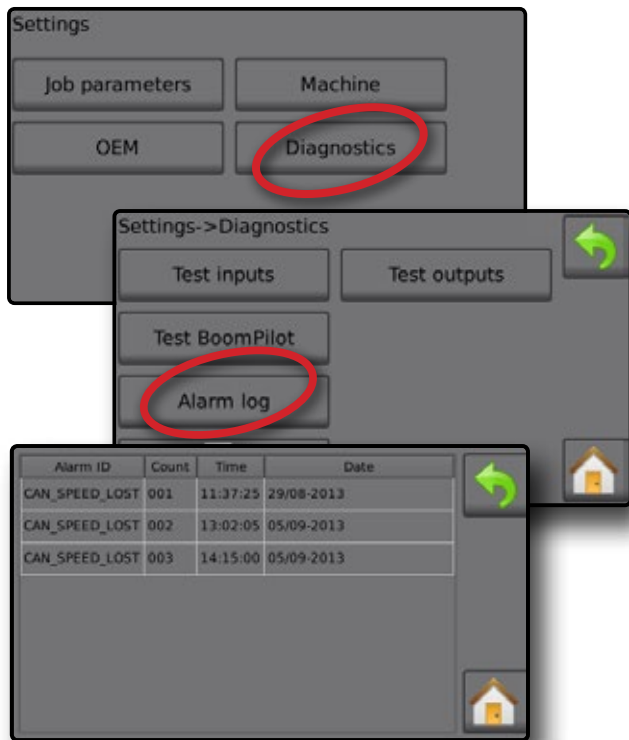
1. Insert USB drive into the unit.
2. Press LOG button .
3. Tap anywhere on the Log data saved screen to return to the diagnostics screen.

Figure 1-53: Alarm log



SETTINGS MENU OPTIONS

The main settings menu contains four (4) options: Job parameters, Machine, OEM and Diagnostics. Each of these options either directly access settings or additional menus. The table below outlines the additional menus, options available on that menu item, and directs you to the setup pages for further information.

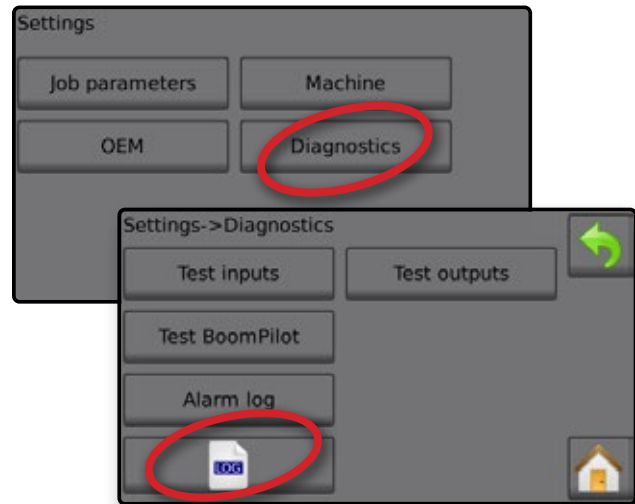
* Options may also be set up from Operations screen

✓ Always available

- ❶ Available with purchase of CAN BoomPilot® unlock code
- ❷ Available with Flow sensor
- ❸ Available with Liquid pressure sensor
- ❹ Available with Fill flow sensor
- ❺ Available with Tank sensor

Job parameters		Application rate number	✓
	-	*Application rate	✓
		*Nozzle type	✓
		Idle pressure	❸
Machine	- *Filling	Actual content	✓
		Full tank	❷ ❸
		Density type	✓
		Density factor	✓
		Desired content	❹ ❺
		Actual content	❹ ❺
		Automatic filling	❹ ❺
	- Operation	Application rate step	
		Speed source	✓
		Simulated speed	
		Minimum speed	
	- Section configuration	Section number	
		Number of nozzles	
Copy section		✓	
Section width			
- Implement parameters		Nozzle preset	
		Nozzle series	
		Nozzle capacity	
		Factory settings	✓
		Low pressure limit	
		High pressure limit	
		Reference flow	
Reference pressure			
- Regulation parameters	Course valve calibration		
	Fine valve calibration	✓	
	Nozzle spacing		
	Regulation mode		

(continued on next page)

Radion 8140 automatic sprayer control

INTRODUCTION

OPERATION

SETTINGS

DATA

CONSOLE

TOOLS

APPENDIX

Machine (continued)	-	Implement speed sensor	Calibration number Automatic calibration	✓		
		-	Flow sensor	Calibration number Low flow limit High flow limit Automatic calibration	②	
	-			Liquid pressure sensor	No pressure No pressure calibration	③
		Maximum pressure Maximum pressure Reference pressure Automatic calibration				
	-	Calibrations	-	Fill flow sensor	Calibration number Automatic calibration	④
					Empty tank Automatic calibration	
		-	Tank level sensor	Minimum tank level Automatic calibration	⑤	
				Maximum tank level Automatic calibration		
				Tank shape Calibration		
			Import/export settings			
-	Alarms	Minimum tank content Flow/pressure cross check Section output low	✓			
OEM	-	Sensor presence	Flow sensor Liquid pressure sensor Fill flow sensor Tank sensor	✓		
	-	Implement parameters	Number of sections Circulation Display rate smoothing	✓		
	-	Valve setup	Regulation valve type Section valve type Section valve behaviour	✓		
	-	Tank setup	Maximum tank contents Minimum tank contents Automatic filling Automatic filling offset	✓		
	-	Regulation details	Minimum regulation pressure Maximum regulation pressure Regulation valve time Minimum regulation voltage Regulation deadband Regulation valve capacity Regulation start delay Manual regulation speed Restrictor plate flow Default valve position	✓		
	-	Clear totals				
Diagnostics	-	Test inputs		✓		
	-	Test outputs		✓		
	-	Test BoomPilot		①		
	-	Alarm log		✓		

CHAPTER 1 – DATA

 The Data option, provides an overview of various system counters including job counters, campaign counters and total counters. From Data options screens, export as either PDF or CSV reports.

1. From the Home screen, press the DATA button 
2. Select from:
 - ▶ Jobs – displays, deletes and reports on job information
 - ▶ Campaign – displays and deletes campaign information
 - ▶ Totals – displays all counter information
 - ▶ CSV – compiles a CSV report of counters for all jobs, and for the campaign and console totals, then saves reports to a USB drive

Figure 1-1: Data management options



Jobs

One of up to ten (10) jobs may be selected to view job information. The current job, displayed/active on the Operation screen, may be exported as a PDF report.

Job information includes:

- ◀ Job number of information displayed
- ◀ Current date
- ◀ Applied area
- ◀ Volume of material applied
- ◀ Distance travelled
- ◀ Time travelled



1. From the Home screen, press the DATA button 
2. Press **Jobs**.
3. Press **Job number** to view information for a different job.
 - ◀ Enter any number to display another job
4. Press RETURN arrow  to return to the main Data screen.

Figure 1-2: Job data



Radion 8140 automatic sprayer control

INTRODUCTION

OPERATION

SETTINGS

DATA





CONSOLE

TOOLS

APPENDIX

Job data report

The PDF button compiles active job information to be exported as a PDF report.

1. From the Home screen, press the DATA button .
2. Press **Jobs**.
3. Select the job from which to create a report.
4. Insert USB drive into the console and wait for PDF button  to activate.
5. Press PDF button .
6. Press RETURN arrow  to return to the main Data screen.

NOTE: The PDF icon  is not available for selection (greyed out) until a USB drive is inserted properly.

Figure 1-3: Job data



Campaign

Campaign displays information for all jobs including applied coverage area, volume of material applied and time travelled.



1. From the Home screen, press the DATA button .
2. Press **Campaign**.
3. Press RETURN arrow  to return to the main Data screen.

Figure 1-4: Campaign data



Clear all campaign counters

Clear all information for all jobs including applied coverage area, volume of material applied and time travelled.

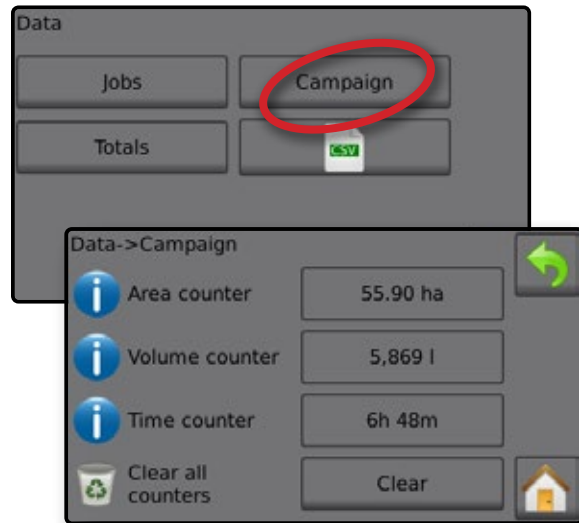

1. From the Home screen, press the DATA button .
2. Press **Campaign**.
3. Press **Clear**.
4. Press RETURN arrow  to return to the main Data screen.

Figure 1-5: Clear all campaign counters



Totals

Total Counters displays information for all activity on the console regarding applied coverage area, volume of material applied, and time travelled for all jobs. Total Counters may only be cleared in the OEM menu.

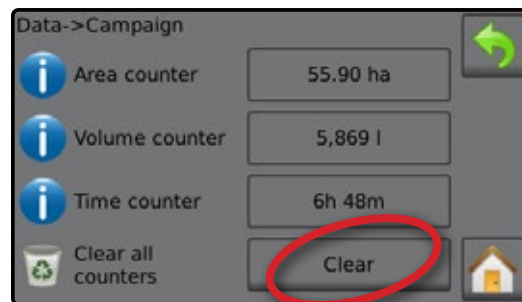





1. From the Home screen, press the DATA button .
2. Press **Totals**.
3. Press RETURN arrow  to return to the main Data screen.

Figure 1-6: Total data

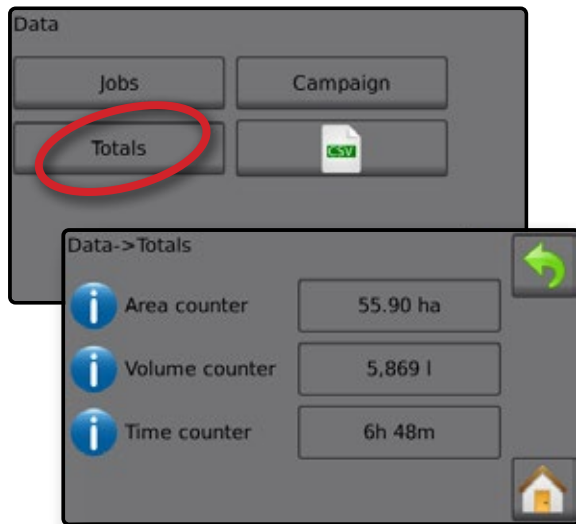

CSV report

The CSV button compiles active job information to be exported as a CSV file.

1. From the Home screen, press the DATA button .
2. Insert USB drive into the console and wait for CSV button  to activate.
3. Press CSV button .
4. Press RETURN arrow  to return to the main Data screen.



NOTE: The CSV icon  is not available for selection (greyed out) until a USB drive is inserted properly.

Figure 1-7: Job data

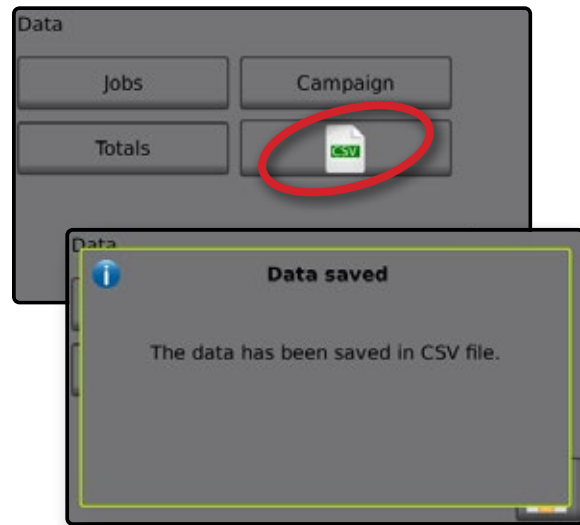

CHAPTER 5 – CONSOLE

 The CONSOLE setup is used to configure the display and cultural settings.

1. From the Home screen, press the CONSOLE button .
2. Select from:
 - ▶ Display – configures colour scheme and LCD brightness, establishes screenshot availability and calibrates the touchscreen
 - ▶ Cultural – configures units, language, date and time settings
 - ▶ Sound – turns the key beeps on/off
 - ▶ Unlock – unlocks additional features
 - ▶ About – displays the system software version

Figure 5-1: The CONSOLE options



Display

Display configures colour schemes and LCD brightness, establishes screenshot availability and calibrates the touchscreen.



1. From the Home screen, press the CONSOLE button .
2. Press **Display**.
3. Select from:
 - ▶ User interface colour scheme – changes the background and text colours on the display
 - ▶ LCD brightness – adjusts the brightness of the Console display
 - ▶ Screenshot – allows screen images to save to a USB drive
 - ▶ Touchscreen calibrate – forces a touch screen calibration
4. Press RETURN arrow  to return to the main Console settings screen.

Figure 5-2: Display options



Cultural

Cultural configures language, units, date and time settings.

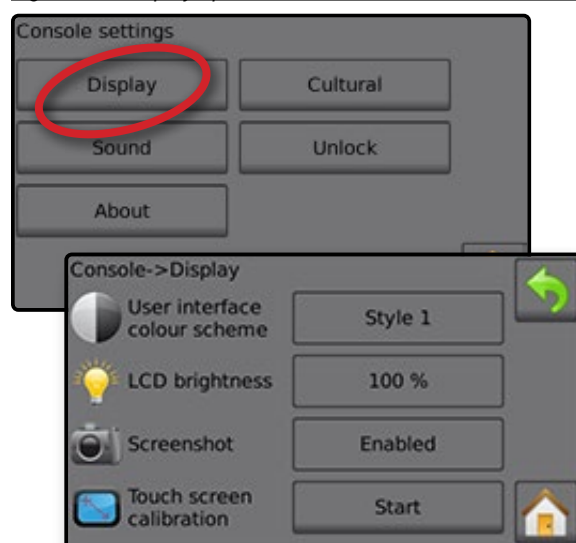

1. From the Home screen, press the CONSOLE button .
2. Press **Cultural**.
3. Select from:
 - ▶ Language – defines the system language
 - ▶ Units – defines the system measurements
 - ▶ Date – establishes the date
 - ▶ Time – establishes the time
4. Press RETURN arrow  to return to the main Console settings screen.

Figure 5-3: Cultural options



Language selection



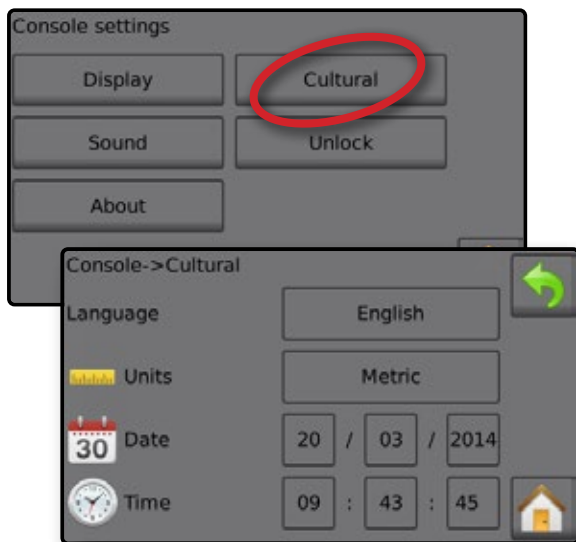

1. From the Console settings screen press **Cultural**.
2. From the Cultural screen press **Language**.
3. Select a language:
 - ▶ Press the Right and Left arrows   to toggle between language selection screens
 - ▶ Press any language button to select a language and return to the Console->Culture screen
 - ◀Date will automatically setup to match language selection
 - ▶ Press the RETURN arrow  to return to the Console settings screen or press the HOME button  to return to the Home screen.

Figure 5-4: Language selection



Code	Language
cs	Czech
da	Danish
de-DE	German
en-GB	English (international)
en-US	English (USA)
es-ES	Spanish (Europe)
es	Spanish (Central/South America)
fr-FR	French
hu	Hungarian
it-IT	Italian
nl	Dutch
pl	Polish
pt-BR	Portuguese (Brazil)
ru	Russian
sk	Slovak

NOTE: Some languages listed may not be available on the console.

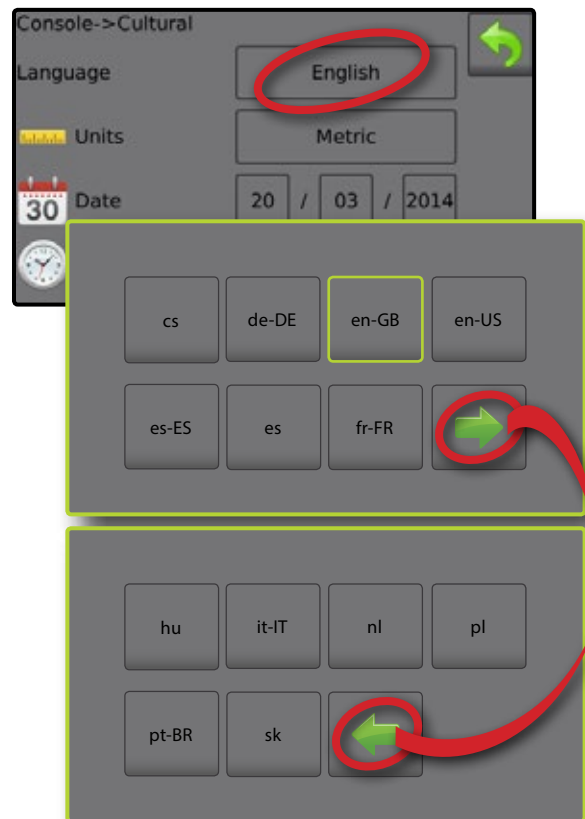
Radion 8140 automatic sprayer control

Sound

Sound enables or disables the key beep.



1. From the Home screen, press the CONSOLE button .
2. Press **Sound**.
3. Select to enabled/disabled key beep.
4. Press RETURN arrow  to return to Console settings screen.

Figure 5-5: Sound option



Unlock

Unlock gives access to advanced features using an unlock code. Contact a local dealer for codes and specific product information.

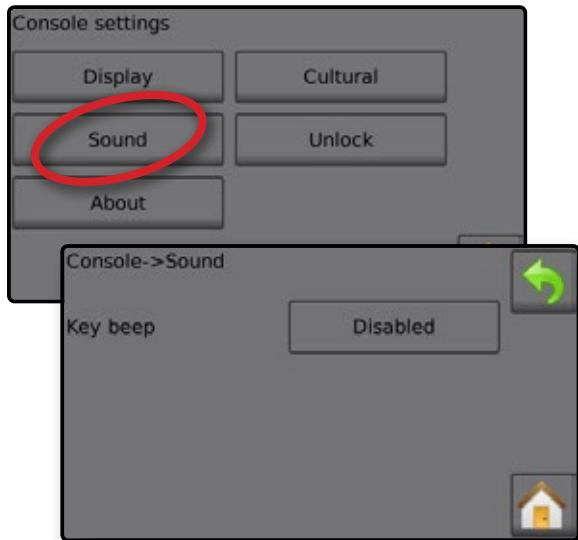
1. From the Home screen, press the CONSOLE button .
2. Press **Unlock**.
3. Select a feature to unlock.
4. Enter an unlock code.
5. Restart the console.

Figure 5-6: Unlock option



About

About/save screen displays the system software version.

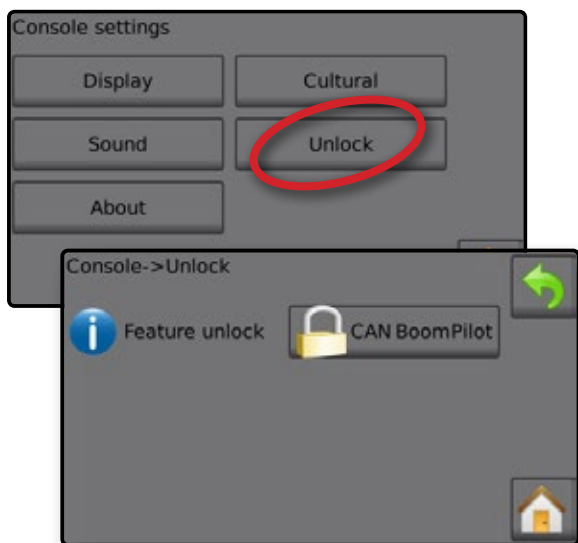
To help troubleshoot problems in the field, press **Save** to download a text file containing current software information to a USB drive, then e-mail the file to support personnel.

1. From the Home screen, press the CONSOLE button .
2. Press **About** to view data including:
 - ◀ Unit model number
 - ◀ Software version

OR

3. Press **Save** to save the About information to a USB Drive. "Saved version information to USB drive" message confirms the save.
4. Press RETURN arrow  to return to the main the Console settings screen.

NOTE: The **Save** option is not available for selection (greyed out) until a USB drive is inserted properly.

Figure 5-7: About options

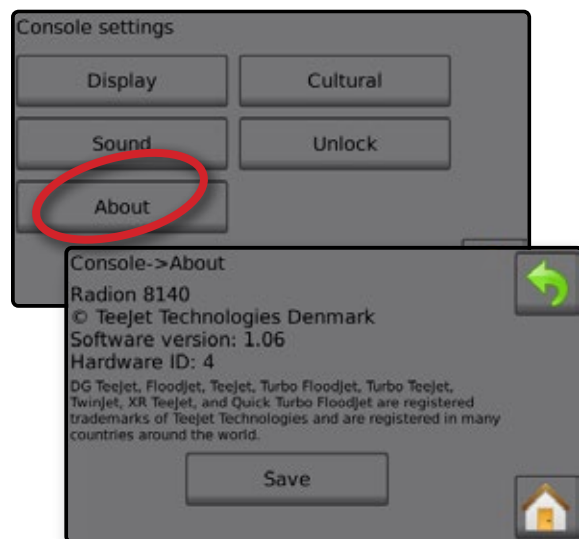

NOTE: In the example above, the unit model number is Radion 8140 and the software version is 1.06.

CHAPTER 1 – TOOLS

 The Tool menu allows the operator to do various calculations using a regular calculator or a unit converter. The unit converter calculates various measurements based on area, length or volume.



1. From Home screen , press TOOLS button .
2. Select from:
 - ▶ Calculator – performs mathematical calculations
 - ▶ Units converter– performs unit conversions for area, length and volume

Figure 1-1: Tools

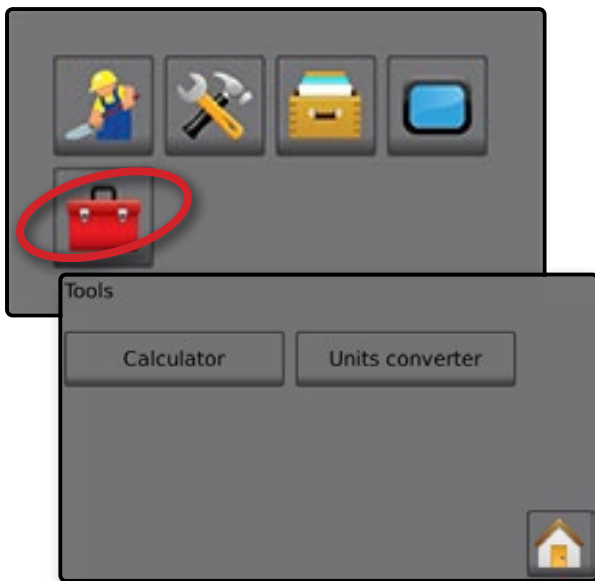

Figure 1-2: Calculator

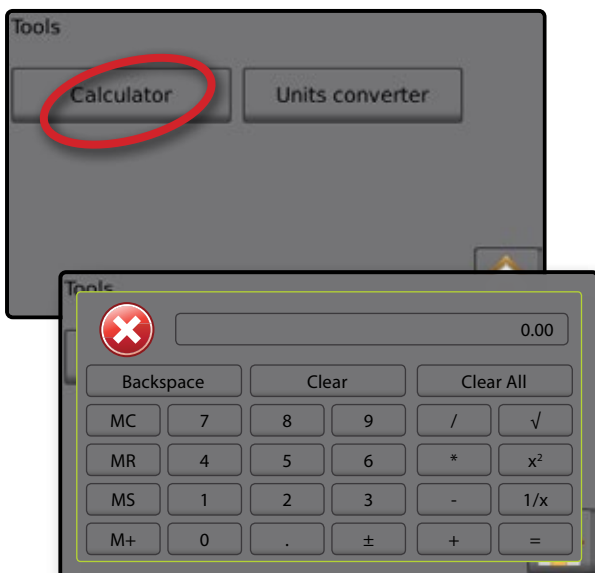

Figure 1-3: Units converter



Radion 8140 automatic sprayer control

APPENDIX A – SYSTEM CONFIGURATIONS AND CONNECTIONS

CONFIGURATIONS

The following diagram is reflective of typical Radion configuration. Due to the variety of possible configurations, this should be used for reference purposes only.

Figure 1-1: System diagram

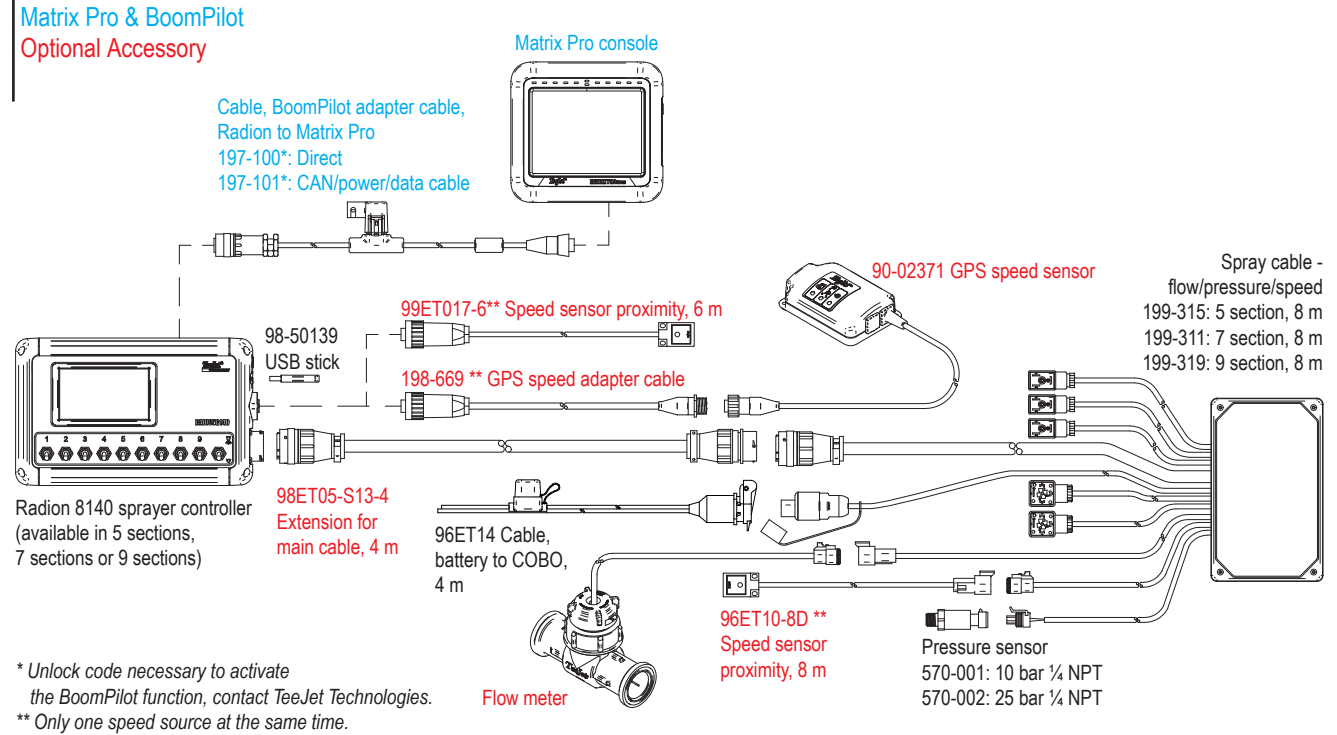

CONNECTIONS

Radion console connections

Figure 1-2: Radion console connections

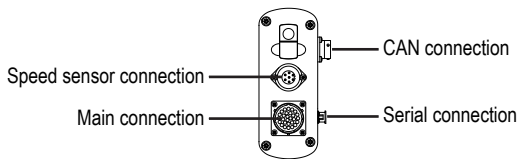

Speed connection on Radion console

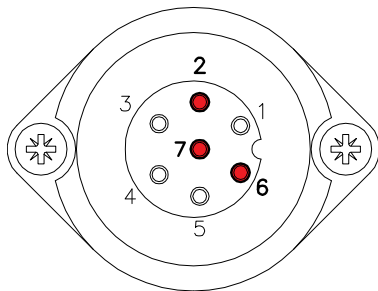

Table 1-1: Speed connection

Pin No.	Signal Name
2	Speed
6	+12V switched
7	Ground

CAN connection on Radion console

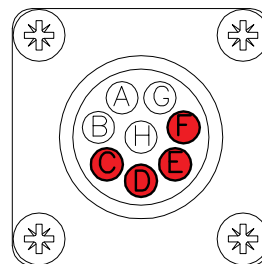
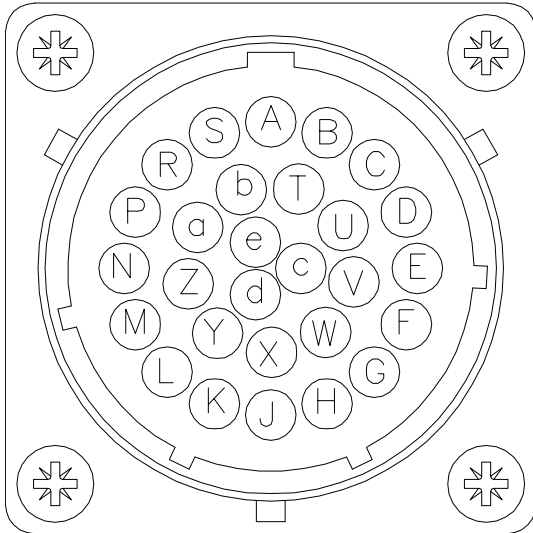

Table 1-2: CAN connection

Pin No.	Signal Name
C	+12V
D	Ground
E	CAN high
F	CAN low

Main connection on Radion console



Serial connection on Radion console

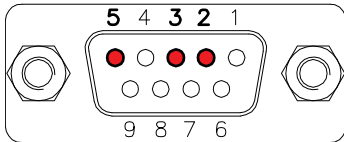

Table 1-3: Serial connection

Pin No.	Signal Name
2	Transmit
3	Receive
5	Ground

Table 1-4: Main connection

Pin No.	Signal Name
A	Master
B	Section 1
C	Section 2
D	Section 3
E	Section 4
F	Section 5
G	Section 6
H	Section 7
J	Section 8
K	Section 9
L	n/a
M	n/a
N	Tank sensor / Fill flowmeter (optional)
P	Fill valve
R	Flow
S	Pressure
T	Speed
U	Balance up (optional)
V	+12V sensor
W	Balance down (optional)
X	Balance potmeter (optional)
Y	Balance potmeter (optional)
Z	Balance potmeter (optional)
a	Regulation +
b	Regulation -
c	Master in
d	Ground in
e	+12V in

Miscellaneous connections

General spray cable connections

Figure 1-3: General spray cable connections

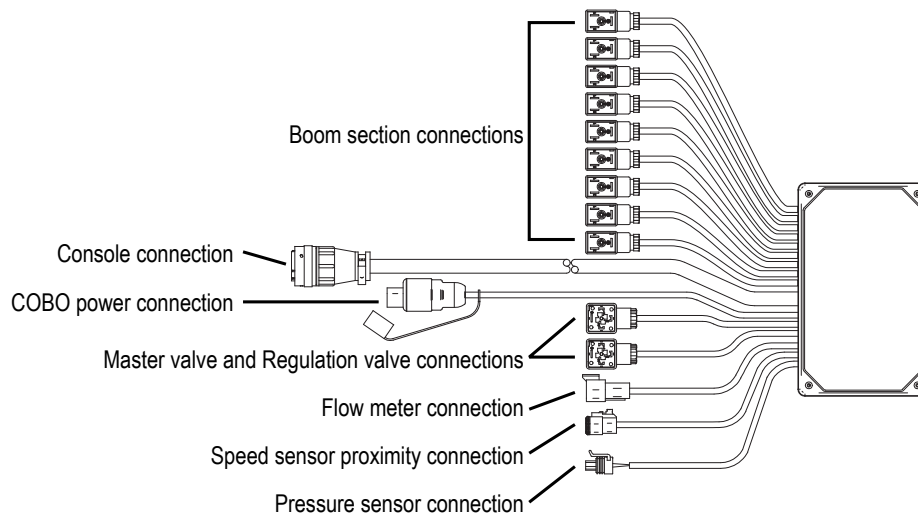

APPENDIX B – USER SETTING NOTES

INTRODUCTION

OPERATION

SETTINGS

DATA

CONSOLE

TOOLS

APPENDIX

Settings-> Job parameters

Description	User setting
Target application rates	No. 1
	No. 2
	No. 3

NOTE: Go to Settings->Job parameters->Application rate; or go to Settings->Machine->Implement parameters->Nozzle preset setup.

Settings-> Machine-> Filling

Description	User setting
Density type	
Density factor (fertiliser)	

NOTE: Go to Operation->Filling (1) and (2) (via Tank icon) or go to Settings->Machine->Filling (1) and (2).

Settings-> Machine-> Operation

Description	User setting
Application rate step	
Speed source	
Simulated speed	
Minimum speed	

NOTE: Go to Settings->Machine->Operation.

Settings-> Machine-> Implement parameters

Section configuration

Description	User setting
Number of nozzles Section 1	
Number of nozzles Section 2	
Number of nozzles Section 3	
Number of nozzles Section 4	
Number of nozzles Section 5	
Number of nozzles Section 6	
Number of nozzles Section 7	
Number of nozzles Section 8	
Number of nozzles Section 9	
Number of nozzles Section 10	
Number of nozzles Section 11	
Number of nozzles Section 12	
Number of nozzles Section 13	

NOTE: Go to Settings->Machine->Implement parameters->Section configuration.

The number of available sections is dependent upon the console model.

Nozzle preset setups

Nozzle preset No. 1	User setting
Nozzle series	
Nozzle capacity	
Low pressure limit	
High pressure limit	
Reference flow	
Reference pressure	

Nozzle preset No. 2	User setting
Nozzle series	
Nozzle capacity	
Low pressure limit	
High pressure limit	
Reference flow	
Reference pressure	

Nozzle preset No. 3	User setting
Nozzle series	
Nozzle capacity	
Low pressure limit	
High pressure limit	
Reference flow	
Reference pressure	

Nozzle preset No. 4	User setting
Nozzle series	
Nozzle capacity	
Low pressure limit	
High pressure limit	
Reference flow	
Reference pressure	

Nozzle preset No. 5	User setting
Nozzle series	
Nozzle capacity	
Low pressure limit	
High pressure limit	
Reference flow	
Reference pressure	

NOTE: Go to Settings->Machine->Implement parameters->Nozzle preset setup to access nozzle preset setups.

Regulation parameters

Description	User setting
Course valve calibration	
Fine valve calibration	
Nozzle spacing	
Regulation mode	

NOTE: Go to Settings->Machine->Implement parameters->Regulation parameters.

Settings-> Machine-> Calibrations

Implement speed sensor

Description	User setting
Calibration number	

NOTE: Go to Settings->Machine->Calibrations->Implement speed sensor. Some options may not be available depending upon OEM sensor settings.

Flow sensor

Description	User setting
Calibration number	
Low flow limit	
High flow limit	

NOTE: Go to Settings->Machine->Calibrations->Flow sensor. Some options may not be available depending upon OEM sensor settings.

Liquid pressure sensor - maximum pressure option

Description	User setting
Maximum pressure	
Reference pressure	

NOTE: Go to Settings->Machine->Calibrations->Liquid pressure sensor->Maximum pressure sensor. Some options may not be available depending upon OEM sensor settings.

Fill flow sensor

Description	User setting
Calibration number	

NOTE: Go to Settings->Machine->Calibrations->Fill flow sensor. Some options may not be available depending upon OEM sensor settings.

Tank level sensor

NOTE: Manual calibration is not available for any Tank level sensor calibrations.

Settings-> Machine-> Alarms

Description	User setting
Minimum tank content	
Flow/pressure cross check	
Section output low	

NOTE: Go to Settings->Machine->Alarms.

Radion 8140 automatic sprayer control

APPENDIX C – ALARM CONFIGURATIONS

Code	Message / condition	Possible solution	Console path
1	No flow impulses	Check flow sensor from test menu. Check components and programming steps related to flow.	Settings->Diagnostics->Test inputs (1)->Flow sensor
2	Low liquid pressure	Check flow sensor from test menu. Check components and programming steps related to flow.	Settings->Machine->Implement parameters->Nozzle preset setup (2) or Settings->Machine->Calibrations or Settings->Diagnostics->Test inputs (2)->Liquid pressure sensor
4	Calibration error	Check components and programming steps related to implement or process registering a calibration error.	Settings->Machine->Calibrations - check sensors
5	Density not equal to water (1 kg/l or 8.34 lb/gal)	Select Water for tank contents or change fertiliser density No..Check components and programming steps related to content.	Operation->Filling (1) or Settings->Machine->Filling (1)
6	Below minimum speed	Increase speed. Check components and programming steps related to speed.	Settings->Machine->Operation or Settings->Machine->Calibrations->Implement speed sensor
7	Pressure based	Check components and programming steps related to implement or process registering a pressure error.	Settings->Diagnostics->Test inputs or Settings->Machine->Implement parameters->Nozzle preset setup (2)
8	Low flow	Increase speed. Check or clean nozzles. Check components and programming steps related to flow.	Settings->Diagnostics->Test inputs or Settings->Machine->Implement parameters->Nozzle preset setup (2)
9	Tank almost empty	Refill tank. Check all components and programming steps related to contents.	Operations->Tank->Filling (1) or Settings->Machine-> filling (1) and (2) or Settings->Machine-> Alarms-> Minimum tank contents
10	Target rate impossible to reach	Select a new target rate. Use larger nozzles. Check components and programming steps related to rates.	Operation->Target rates or Settings->Job parameters
11	Actual rate too high	Select a lower target rate. Check components and programming steps related to rates.	Operation->Target rates or Settings->Job parameters
12	Minimum regulation pressure	Check components and programming steps related to pressure.	Settings->Machine->Implement parameters-> Regulation parameters
13	Maximum regulation pressure	Check components and programming steps related to pressure.	Settings->Machine->Implement parameters-> Regulation parameters
14	Pressure too low	Check components and programming steps related to pressure.	Settings->Machine->Implement parameters->Nozzle preset setup (2)
15	Pressure too high	Check components and programming steps related to pressure.	Settings->Machine->Implement parameters-> Nozzle preset setup (2)
16	Pressure/flow check	Check components and programming steps related to flow.	Settings->Diagnostics->Test inputs or Settings-> Machine->Calibrations
19	Liquid pressure too low	Check flow sensor from test menu. Check components and programming steps related to pressure.	Settings->Machine->Implement parameters->Nozzle preset setup (2) or Settings->Machine->Calibrations or Settings->Diagnostics->Test inputs (2)->Liquid pressure sensor
20	Liquid pressure too high	Check flow sensor from test menu. Check components and programming steps related to pressure.	Settings->Machine->Implement parameters->Nozzle preset setup (2) or Settings->Machine->Calibrations
21	No speed signal	Check components and programming steps related to speed.	Settings->Machine->Calibrations->Implement speed sensor
31	Work not possible		
34	Save error	Insert or reset a USB device if saving to a USB port.	
36	CAN speed missing	Check GPS source for power/satellite reception. If no GPS source, change speed source. Check components and programming steps related to speed.	Settings->Machine->Operation->Speed source
45	BoomPilot unit not responding	Check BoomPilot for power. Test BoomPilot under test menu.	Settings->Diagnostics->Test BoomPilot
46	BoomPilot unit in manual mode	Current operation mode is different than standard operation. If this is undesired, change mode to automatic under test menu.	Settings->Diagnostics->Test BoomPilot
47	Not all sections on	Current operation mode is different than standard operation. If this is undesired, check section switches are flipped up (ON). Check sections under test menus. Configure sections. Check components and programming steps related to power.	Settings->Diagnostics->Test outputs (2) or Settings->Diagnostics->Test inputs (3)->Section switches or Settings->Machine->Implement parameters->Section configuration
49	Section output failure	Check components and programming steps related to sections.	Settings->Diagnostics->Test outputs (2)
50	Master output failure	Check Master switch if flipped up (ON). Check all components and programming steps related to Master switch.	Settings->Diagnostics->Test inputs (3)->Master switch
51	Fill valve output failure	Check fill valve under test menus. Check components and programming steps related to fill valve.	Settings->Diagnostics->Test outputs (2)->Fill valve
52	Low supply voltage	Check voltage supply under Diagnostics.	Settings->Diagnostics->Supply voltage

APPENDIX D – UNIT SPECIFICATIONS

Dimensions	Radion 8140, 5-section	228.6 x 158.0 x 61.6 mm
	Radion 8140, 7-section	228.6 x 158.0 x 61.6 mm
	Radion 8140, 9-section	254.0 x 158.0 x 61.6 mm
Weight	Radion 8140, 5-section	1.3 kg
	Radion 8140, 7-section	1.3 kg
	Radion 8140, 9-section	1.9 kg
Connector	Power/CAN	8-pin Conxall
	Speed/status	8-pin Conxall
	Main	28-pin
	Serial	9-pin
Environmental	Storage	-10 to +70°C
	Operating	0 to +50°C
	Humidity	90% non-condensing
Display	Radion 8140	320 x 240 resolution 4.3"
Input/output		USB 2.0
Power requirement		< 9 watts @ 12 VDC

RADION 8140

USER MANUAL

Product upgrades available

- Matrix Pro® guidance
- BoomPilot® automated boom section control



www.teejet.com

A Subsidiary of  *Spraying Systems Co.*

98-05311-EN-A4 R3 English-International
© TeeJet Technologies 2018