

A

B

C

D

1

2

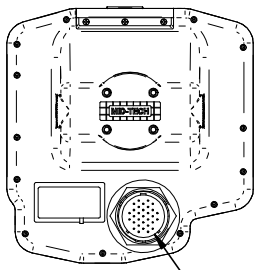

3

4

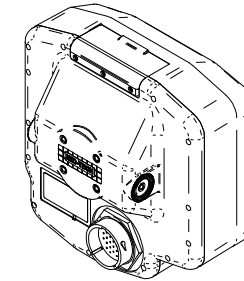
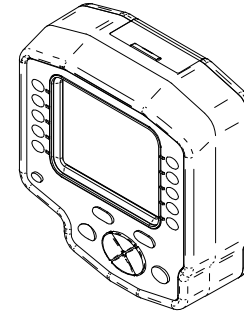
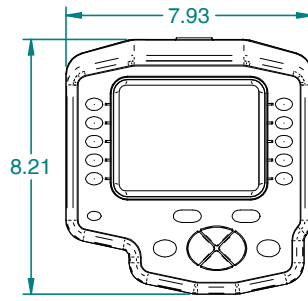
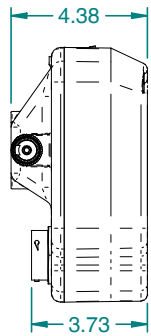

Deutsch  
31 Pos.  
w/Pins



MATERIAL:		n/a			
FINISH:		n/a			
PROJECTION:		SCALE:	UNITS:	TITLE:	
		1:2	X	L6k Color w/Trimble AP SFTWR	
UNLESS OTHERWISE SPECIFIED TOLERANCE:		DRAWN BY:		CHECKED BY:	
0-1" +/- .1" 1-5" +/- .25" 5-10" +/- .5"		10-60" +/- 1" 60-120" +/- 2" 120" +/- 3"		<i>Ryan Reiser</i> APPROVED BY:	
REV.	DATE	NOC No	3XX	SHEET No:	DWG No:
			1 of 1	C-75-05009	
Midwest Technologies IL, LLC. Claims proprietary right in the material disclosed hereon. This document is not to be used in any way detrimental to the interest of Midwest Technologies IL, LLC.					