

STREAMJET® SJ7

BOQUILLA DE FERTILIZANTE LÍQUIDO



Pulverización avanzada del abono líquido con StreamJet SJ-7, la boquilla de siete orificios; sucesivo de los casquillos de montaje de orificio TeeJet 8.

Ventajas y Características

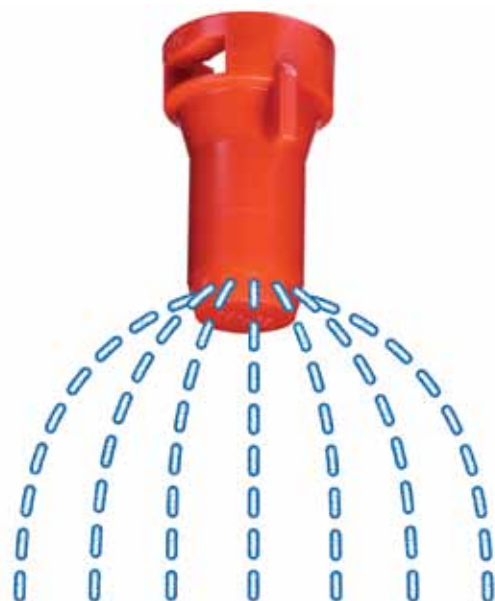
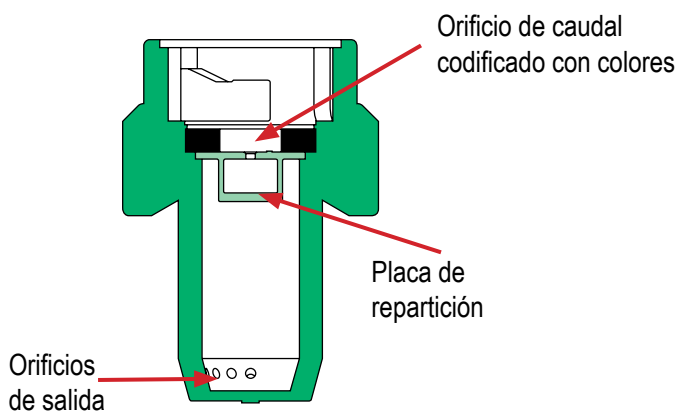
- Siete chorros directos y precisos forman gotas sumamente grandes con potencia de choque mínimar
- Repartición excelente debido al patrón de chorro semicircular – con solape correspondiente
- Nueva gama más amplia de tamaños (-015 hasta -15) proporciona una opción de volúmenes de aplicación significativamente más extensa, especialmente para abonos a base de nitrógeno
- Codificación de colores ISO (VisiFlo®) para selección fácil del tamaño de la boquilla
- Preorificio integrado desmontable, codificado con colores
- La longitud total es la misma que la de la AI TeeJet; chorro de pulverización a un ángulo de 15° de la horizontal, proporciona una manera práctica para pulverizar bajo los puntales de la barra de pulverización
- Presión de trabajo desde 1,5 hasta 4 bar; Altura de pulverización 75 – 100 cm
- Fabricado en Acetal para alta resistencia a los agroquímicos
- Un alargador de 27 mm es posible con el adaptador 50854-NYB

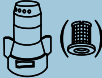

INFORMACIÓN DE APLICACIONES

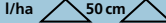
		SALIDA UNA BOQUILLA l/min	l/ha 									
			4 km/h	6 km/h	8 km/h	10 km/h	12 km/h	16 km/h	20 km/h	25 km/h	30 km/h	35 km/h
SJ7-015-VP (100)	1,5	0,39	117	78,0	58,5	46,8	39,0	29,3	23,4	18,7	15,6	13,4
	2,0	0,46	138	92,0	69,0	55,2	46,0	34,5	27,6	22,1	18,4	15,8
	2,5	0,52	156	104	78,0	62,4	52,0	39,0	31,2	25,0	20,8	17,8
	3,0	0,57	171	114	85,5	68,4	57,0	42,8	34,2	27,4	22,8	19,5
	4,0	0,67	201	134	101	80,4	67,0	50,3	40,2	32,2	26,8	23,0
SJ7-02-VP (50)	1,5	0,55	165	110	82,5	66,0	55,0	41,3	33,0	26,4	22,0	18,9
	2,0	0,64	192	128	96,0	76,8	64,0	48,0	38,4	30,7	25,6	21,9
	2,5	0,72	216	144	108	86,4	72,0	54,0	43,2	34,6	28,8	24,7
	3,0	0,80	240	160	120	96,0	80,0	60,0	48,0	38,4	32,0	27,4
	4,0	0,93	279	186	140	112	93,0	69,8	55,8	44,6	37,2	31,9
SJ7-03-VP (50)	1,5	0,87	261	174	131	104	87,0	65,3	52,2	41,8	34,8	29,8
	2,0	1,00	300	200	150	120	100	75,0	60,0	48,0	40,0	34,3
	2,5	1,10	330	220	165	132	110	82,5	66,0	52,8	44,0	37,7
	3,0	1,18	354	236	177	142	118	88,5	70,8	56,6	47,2	40,5
	4,0	1,31	393	262	197	157	131	98,3	78,6	62,9	52,4	44,9
SJ7-04-VP (50)	1,5	1,17	351	234	176	140	117	87,8	70,2	56,2	46,8	40,1
	2,0	1,33	399	266	200	160	133	99,8	79,8	63,8	53,2	45,6
	2,5	1,45	435	290	218	174	145	109	87,0	69,6	58,0	49,7
	3,0	1,55	465	310	233	186	155	116	93,0	74,4	62,0	53,1
	4,0	1,72	516	344	258	206	172	129	103	82,6	68,8	59,0
SJ7-05-VP (50)	1,5	1,49	447	298	224	179	149	112	89,4	71,5	59,6	51,1
	2,0	1,68	504	336	252	202	168	126	101	80,6	67,2	57,6
	2,5	1,83	549	366	275	220	183	137	110	87,8	73,2	62,7
	3,0	1,95	585	390	293	234	195	146	117	93,6	78,0	66,9
	4,0	2,16	648	432	324	259	216	162	130	104	86,4	74,1
SJ7-06-VP (50)	1,5	1,77	531	354	266	212	177	133	106	85,0	70,8	60,7
	2,0	2,01	603	402	302	241	201	151	121	96,5	80,4	68,9
	2,5	2,19	657	438	329	263	219	164	131	105	87,6	75,1
	3,0	2,35	705	470	353	282	235	176	141	113	94,0	80,6
	4,0	2,61	783	522	392	313	261	196	157	125	104	89,5
SJ7-08-VP	1,5	2,28	684	456	342	274	228	171	137	109	91,2	78,2
	2,0	2,66	798	532	399	319	266	200	160	128	106	91,2
	2,5	2,94	882	588	441	353	294	221	176	141	118	101
	3,0	3,15	945	630	473	378	315	236	189	151	126	108
	4,0	3,46	1038	692	519	415	346	260	208	166	138	119
SJ7-10-VP	1,5	2,84	852	568	426	341	284	213	170	136	114	97,4
	2,0	3,32	996	664	498	398	332	249	199	159	133	114
	2,5	3,67	1101	734	551	440	367	275	220	176	147	126
	3,0	3,94	1182	788	591	473	394	296	236	189	158	135
	4,0	4,33	1299	866	650	520	433	325	260	208	173	148
SJ7-15-VP	1,5	4,09	1227	818	614	491	409	307	245	196	164	140
	2,0	4,82	1446	964	723	578	482	362	289	231	193	165
	2,5	5,40	1620	1080	810	648	540	405	324	259	216	185
	3,0	5,87	1761	1174	881	704	587	440	352	282	235	201
	4,0	6,58	1974	1316	987	790	658	494	395	316	263	226

NOTA: Siempre verifique dos veces los caudales de aplicación. Las tablas se basan en la pulverización de agua a 21°C.

ALTURA ÓPTIMA DE PULVERIZACIÓN

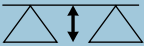
	
50 cm	50 cm
75 cm	75 cm
100 cm	100 cm



TeeJet Orleans
431, Rue de la Bergeresse
Olivet (Orléans), F-45160
France
Tel: +33 238 69 7070 • Fax: +33 238 69 7071
www.teejet.com