

DYNAJET[®] IC7140

INSTALLATION/SETUP/USER MANUAL

Software version 1.01



TeeJet[®]
TECHNOLOGIES

A Subsidiary of  Spraying Systems Co.[®]

Copyrights

© 2019 TeeJet Technologies. All rights reserved. No part of this document or the computer programmes described in it may be reproduced, copied, photocopied, translated, or reduced in any form or by any means, electronic or machine readable, recording or otherwise, without prior written consent from TeeJet Technologies.

Trademarks

Unless otherwise noted, all other brand or product names are trademarks or registered trademarks of their respective companies or organisations.

Limitation of Liability

TEEJET TECHNOLOGIES PROVIDES THIS MATERIAL "AS IS" WITHOUT WARRANTY OF ANY KIND, EITHER EXPRESSED OR IMPLIED. NO COPYRIGHT LIABILITY OR PATENT IS ASSUMED. IN NO EVENT SHALL TEEJET TECHNOLOGIES BE LIABLE FOR ANY LOSS OF BUSINESS, LOSS OF PROFIT, LOSS OF USE OR DATA, INTERRUPTION OF BUSINESS, OR FOR INDIRECT, SPECIAL, INCIDENTAL, OR CONSEQUENTIAL DAMAGES OF ANY KIND, EVEN IF TEEJET TECHNOLOGIES HAS BEEN ADVISED OF SUCH DAMAGES ARISING FROM TEEJET TECHNOLOGIES SOFTWARE.

Table of Contents

IMPORTANT SAFETY INFORMATION	III
GENERAL WARNINGS AND PRECAUTIONS	III
CHAPTER 1 – INTRODUCTION	1
SYSTEM COMPONENTS	1
DynaJet IC7140 Controller	1
Standard Installation System Components	2
Hybrid Installation System Components	4
BASIC SCREEN USE	6
Settings Options Navigation	7
CHAPTER 2 – INSTALLATION	8
DYNAJET IC7140 ECU	8
STANDARD INSTALLATION	10
HYBRID INSTALLATION	11
CHAPTER 3 – INITIAL STARTUP & CALIBRATIONS	12
NO. 1 POWER UP AND INITIALISATION	12
NO. 2 SETUP UP MACHINE	13
NO. 3 SETUP UP AND SELECT NOZZLE	13
NO. 4 GET TO KNOW THE CONTROL MODES	14
NO. 5 PREFORM SYSTEM FUNCTIONAL TEST	15
NO. 6 CALIBRATE THE RATE CONTROLLER REGULATION	15
NO. 7 CALIBRATE THE DYNAJET IC7140 SYSTEM	16
CHAPTER 4 – HOME SCREEN	18
Quick Overview Box.....	19
CHAPTER 5 – MAIN SETUP	20
MACHINE SETUP	21
OEM SETTINGS	22
USER INTERFACE	24
HELP	24
About	25
System Overview	25
UT Data Diagnostics	26
Gyroscope Diagnostics.....	26

	CHAPTER 6 – OPERATION	27
INTRODUCTION	OPERATION MODES	28
	Manual Mode	28
	Droplet Mode	29
	Pressure Mode	29
INSTALLATION	BOOM APPLICATION STATUS	30
	Turn Compensation On	30
	Good Practices Guide	30
	Turn Compensation Off	31
	Droplet Size Chart	31
INITIAL STARTUP	CONTROL ERRORS & ALERTS	32
	NON-TOUCHSCREEN UT OPTIONS	32
	CHAPTER 7 – NOZZLE FAVOURITES	33
HOME SCREEN	NOZZLE PRESETS	34
	CURRENT NOZZLE SELECTION	35
SETUP	CHAPTER 8 – SYSTEM OVERVIEW	36
	DRIVER/SOLENOID INFORMATION	37
	SYSTEM ERRORS	38
	SETUP OPTIONS FOR SOFTWARE v1.01	40
OPERATION	APPENDIX A – 115880 E-CHEMSAVER® MAINTENANCE INSTRUCTIONS	42
	General Disassembly and Reassembly	43
NOZZLE FAVORITES	APPENDIX B – DYNAJET APPLICATION CHARTS	44
	DYNAJET IC7140 NOZZLE SELECTION	44
	Application Rates Available at Given Speed and Nozzle Capacity	46
	Speed Range Available at Given Nozzle Size and Application Rate	50
SYSTEM OVERVIEW	APPENDIX C – TROUBLESHOOTING GUIDE	54
APPENDIX		

IMPORTANT SAFETY INFORMATION

All safety related and operating instructions should be read before the system is operated. Safe operation of machinery is the operators responsibility. Safety procedures must be posted close to the equipment and clearly visible to and legible by the operator. Safety procedures should meet all company and local regulations, as well as MSDS-requirements. For assistance, contact a local dealer.

Safety Alert Symbol Definitions:



DANGER! This symbol is reserved for the most extreme situations where serious personal injury or death is imminent.



WARNING! This symbol indicates a hazardous situation that could result in serious personal injury or death.



CAUTION! This symbol indicates a hazardous situation that could result in minor or moderate personal injury.



NOTE: This symbol addresses practices in which the operator should be aware.

GENERAL WARNINGS AND PRECAUTIONS



DANGER!

- Read and follow instructions. If instructions are unclear after reading the manual, please contact a local dealer.
- Keep children away from equipment.
- Do not operate machinery under the influence of alcohol or any illegal substance.
- Some systems include a fan heater. Never cover the heater otherwise there will be a serious danger of fire!



WARNING! ELECTRICAL / SHOCK HAZARDS

- Before working on any particular component, make sure that all power supplies have been switched off and cannot be accidentally switched on.
- Disconnect power leads before using an arc welder on equipment or anything connected to the equipment.
- Systems including frequency drives have a risk of electric shock due to residual voltage. It is not permissible to open the equipment neither to disconnect the system or any quick connection until 5 minutes after the power has been removed.
- Only operate the system from the power source indicated in the manual. If you are not sure of the power source, consult qualified service personnel.
- Do not use a high pressure cleaner to clean electrical components. This could damage electrical components and subject the operator to risk of electrical shock.
- The electrical supply to the equipment must be properly routed and connected to the equipment. All connections must meet the specified requirements.



WARNING! PRESSURISED HYDRAULIC SYSTEMS

- Always wear personal protective equipment (PPE) when performing work on hydraulic systems.
- Adhere to the machine manufacture's approved maintenance instructions when working on the hydraulic system.
- Always turn equipment off when working on the hydraulic system. Take appropriate precautions when opening systems that have been previously pressurised.
- Be aware that hydraulic oil may be extremely hot and under high pressure.



WARNING! CHEMICAL HANDLING

- Always wear PPE when handling any chemical substance.
- Always follow safety labels and instructions provided by the chemical manufacturer or supplier.
- The operator should have full information on the nature and the quantity of the material to be distributed.
- **ADHERE TO FEDERAL, STATE AND LOCAL REGULATIONS REGARDING THE HANDLING, USE OR DISPOSAL OF AGRICULTURAL CHEMICALS.**



WARNING! PRESSURISED SPRAY SYSTEM

- It is important to recognise proper safety precautions when using a pressurised spray system. Fluids under pressure can penetrate skin and cause serious personal injury.
- The system pressure should never exceed the lowest rated component. Always know your system and all component capabilities, maximum pressures and flow rates.
- Filters can only be opened when the manual valves in front of and behind the filter are in closed position. If any appliance has to be taken out of the piping, manual valves in front of and behind this appliance have to be in closed position. If they are reinstalled, make sure that this happens correctly, that this apparatus is well aligned, and that all connections are tight.
- The plumbing supply to the equipment should meet all company and local regulations and must be properly routed and connected to the equipment. All connections must meet the specified requirements
- It is advised to drain and purge the liquid train when the equipment shall not be used for a longer period of time.



WARNING! AUTO STEERING SAFETY

- To prevent serious personal injury or death from being run over by the vehicle or automated motion of the steering system, never leave the vehicles operator seat with the system engaged.
- To prevent serious personal injury or death from being run over by the vehicle or automated motion of the steering system, verify the area around the vehicle is clear of people or obstacles before startup, calibration, tuning or engaging the system.
- Make sure equipment is tightly secured to the proper components.
- Never drive on public roads with system engaged.



CAUTION! EQUIPMENT SAFETY, MAINTENANCE, AND SERVICE

- The equipment should be operated only by properly trained, qualified personnel. They must have proven their skills in the operation of the equipment.
- Before using the equipment, the operator has to check if the equipment is in good condition and can be used safely. If not, the equipment cannot be used.
- All necessary PPE must be readily available to the operator at all times.
- Routinely check the system and components for wear and damage. Replace or repair when necessary.
- Only qualified authorised experts are allowed to repair or maintain the installation. The maintenance and operating instructions shall be rigidly observed and followed.
- A complete manual for the equipment must be available to the operator or maintenance technician at all times.



CAUTION! HARNESS CABLE AND HOSE SAFETY

- Routinely check all harness cables and hoses for damage or wear. Replace or repair when necessary.
- Do not route harness cables and hoses with sharp bends.
- Do not strap harness cables and hoses to lines with high vibration or spikes in pressure.
- Do not strap harness cables and hoses to lines transporting hot fluids.
- Protect harness cables and hoses from sharp objects, equipment debris, and material buildup.
- Allow sufficient length for harness cables and hoses to have free movement on sections that move during operation, and be sure that harness cables or hoses do not hang below the equipment.
- Allow sufficient clearance for harness cables and hoses from implement and machine operational zones.
- When cleaning equipment, protect harness cables from high pressure wash.



NOTE: TOUCH SCREEN CARE

- Keep sharp objects away from the touch screen device. Touching the screen with a sharp object could result in damage to the display.
- Do not use harsh chemicals to clean the console/display. The correct way to clean a console/display is to use a soft damp cloth or anti-static wipe, similar to cleaning a monitor on a computer.



NOTE: RECOMMENDED REPLACEMENT PARTS

- The system has been designed with components that work together to provide the best system performance. When the system requires replacement parts, only TeeJet recommended components should be used to maintain proper system operation and safety.

CHAPTER 1 – INTRODUCTION

Congratulations on the purchase of your new DynaJet IC7140 ECU built on the ISOBUS architecture. When used within the guidelines of this manual, the DynaJet IC7140 will be a reliable droplet size control system.

Use with your existing Universal Terminal (UT)

- Works seamlessly and displays on any ISOBUS UT
- Easy navigation menu and data rich display
- Add additional ISOBUS ECUs as your needs change
- Standardised plugs, cables and software simplify installation and connectivity and result in true “plug and play” technology. DynaJet IC7140 ECU resides on the implement, reducing hardware in the cab

SYSTEM COMPONENTS

DynaJet IC7140 offers two types of installations, standard and hybrid.

- ▶ Standard Installation – offers dual output drivers that are moulded into the boom harness and tailored to the customers specific equipment.
- ▶ Hybrid Installation – offers eight (8) output driver options where each driver consists of eight (8) nozzle harnesses.

DynaJet IC7140 Controller

The DynaJet IC7140 controller works in conjunction with an existing rate controller that regulates flow via a control valve or pump regulation to achieve a target application rate while maintaining target droplet size(s) when a speed change occurs. This system only works with automatic rate controllers that use flow based monitoring systems and not pressure based monitoring systems. Automatic rate controllers equipped for both flow and pressure based control should have the pressure-based system disabled to work in conjunction with DynaJet IC7140.

The independent automatic rate controller loop performs the same as it would if the DynaJet IC7140 controller were not present. The DynaJet IC7140 controller changes flow output to each individual nozzle based upon input provided from the operator about the optimum droplet size (pressure) for the application.

Figure 1-1: DynaJet IC7140 Controller



Standard Installation System Components









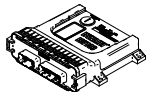

Item	Part #	Description	Illustration
A	DM-01	DynaJet IC7140 ECU Module	
B	DH-01-xxx-xxx-xxx	ISOBUS DynaJet Harness	
C	16-05015	Pressure Sensor	
D	45-05887: 3' / 1 m 45-05886: 25' / 7.5 m	Pressure Sensor Cable	
E	78-05137	Pressure Interface	
F	45-10200	Boom Interface Module (BIM) Harness	
G	DPF-xxxx	Battery Power Extension	
H	DP-01	Power Distribution Module (PDM)	
I	45-05943	Battery Power Feed	
J	78-05091	Boom Interface Module (BIM)	
K	DB2-00x-xxx-xxx-xxx-xxx	DynaJet Driver	
L	DBT-S	Start Terminator	
M	DBT-E	End Terminator	
N	DB2-00x-xxx-xxx-E-xxx	DynaJet Driver with End Terminator	
O	DB2-00x-S-xxx-xxx-xxx	DynaJet Driver with Start Terminator	
P	DBX-xxx	Boom Driver Extension	

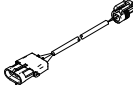
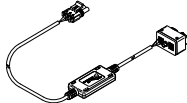
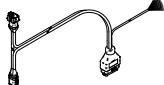
Figure 1-2: DynaJet IC7140 Standard System Diagram

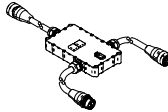
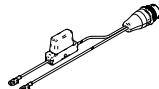

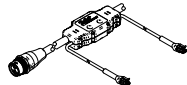
Hybrid Installation System Components

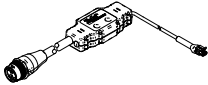
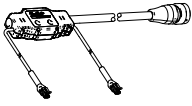

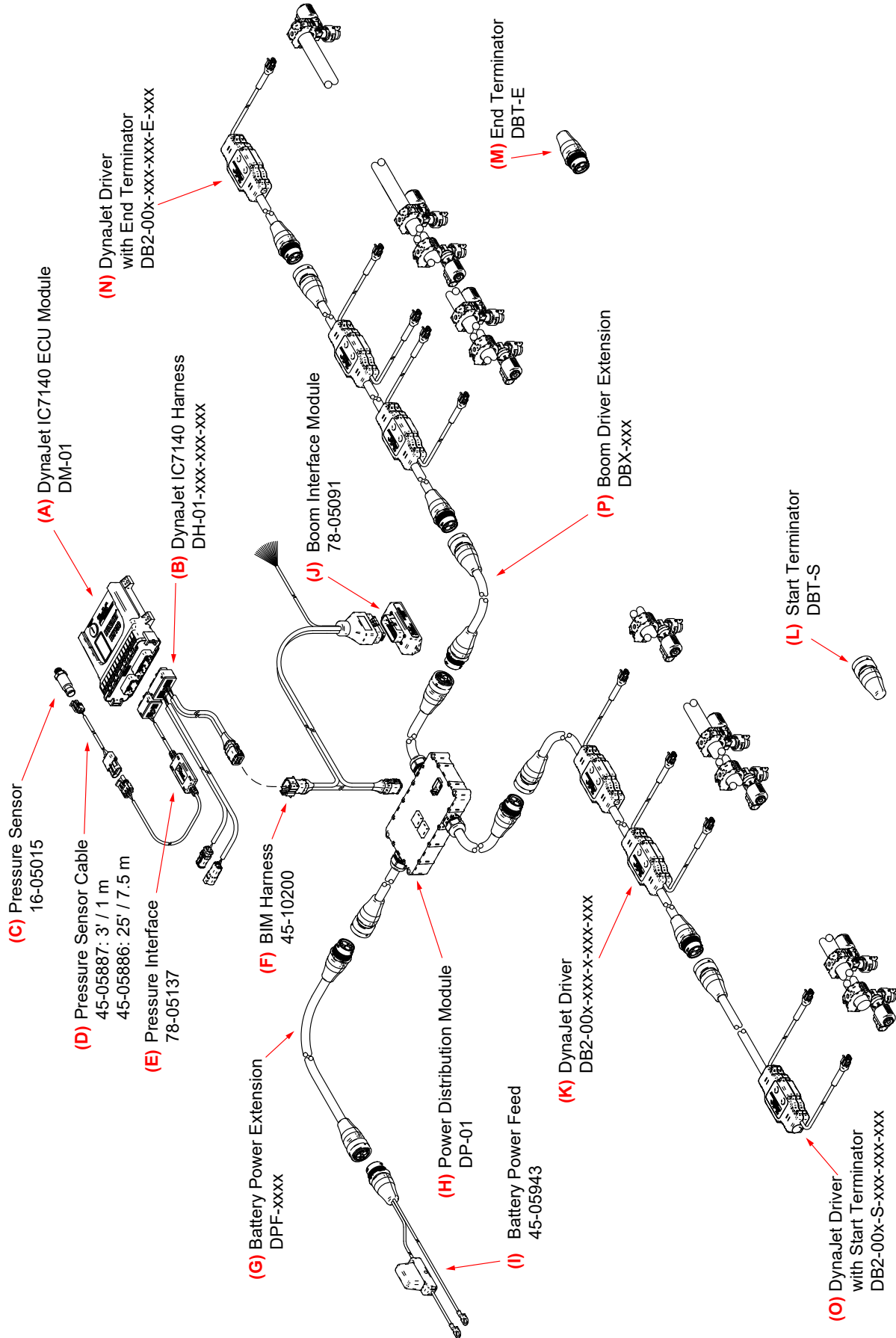

Item	Part #	Description	Illustration
A	DM-01	DynaJet IC7140 ECU Module	
B	45-10207	DynaJet Hybrid ECU Harness	
C	16-05015	Pressure Sensor	
D	45-05887: 3' / 1 m 45-05886: 25' / 7.5 m	Pressure Sensor Cable	
E	78-05137	Pressure Interface	
F	45-10195	Boom Interface Module (BIM) Hybrid Harness	
G	45-04006-03: 3' / 1 m 45-04006-07: 7' / 2 m 45-04006-13: 13' / 4 m 45-04006-20: 20' / 6 m	CAN Extension Cable	
H	45-04006-END	CAN Terminator-END	
I	45-04006-START	CAN Terminator-START	
J	78-05091	Boom Interface Module (BIM)	
K	45-05998-xx	Power Adapter	
L	78-05124	DynaJet HF Driver	
M	45-04005-xx-xx	Nozzle Harness	
N	45-05971	Power Extension Driver	
O	45-05997-15	Driver Power "Y" Cable	
P	78-05121-xx	Power Distribution Module (PDM)	
Q	45-05942-xx	Power Cable 6ga	
R	45-05943	Battery Cable 60 amp Fuse	
S	45-04001-xx	Nozzle Extension	

Figure 1-3: DynaJet IC7140 Hybrid System Diagram

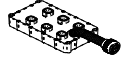
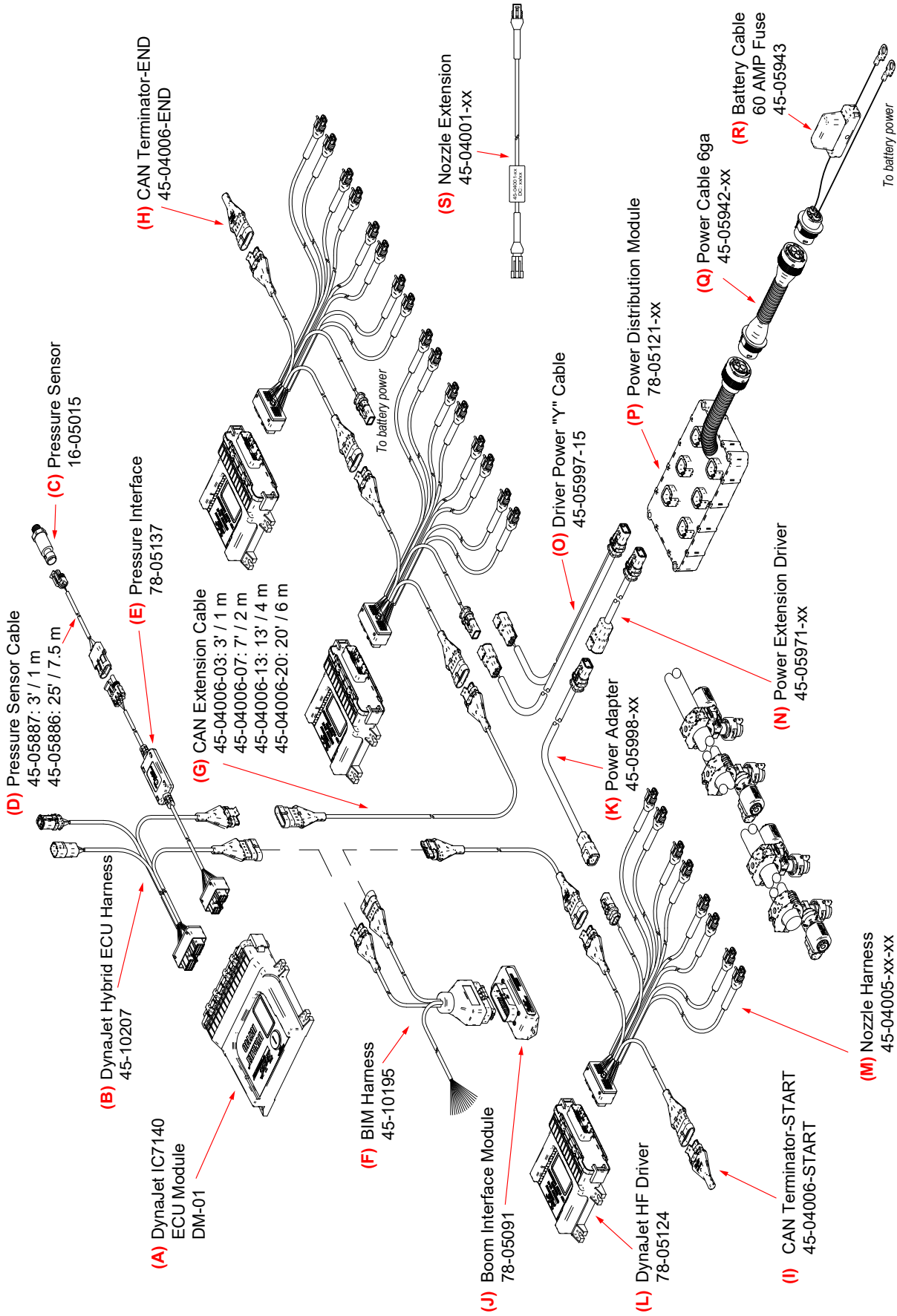

BASIC SCREEN USE

The DynaJet IC7140 display comprises Available ECU buttons, an interactive information display and softkeys.

- A firm touch is required when selecting a screen icon.
- Setup options are NOT automatically saved when selected. The ACCEPT KEY  must be selected to save the setting. Select the ESCAPE KEY  to escape without saving settings and return to the previous menu.

NOTE: The softkey menus and touch screen structure on your display might vary from the one displayed in this user manual depending on the universal terminal being used.

Figure 1-4: Screen Overview

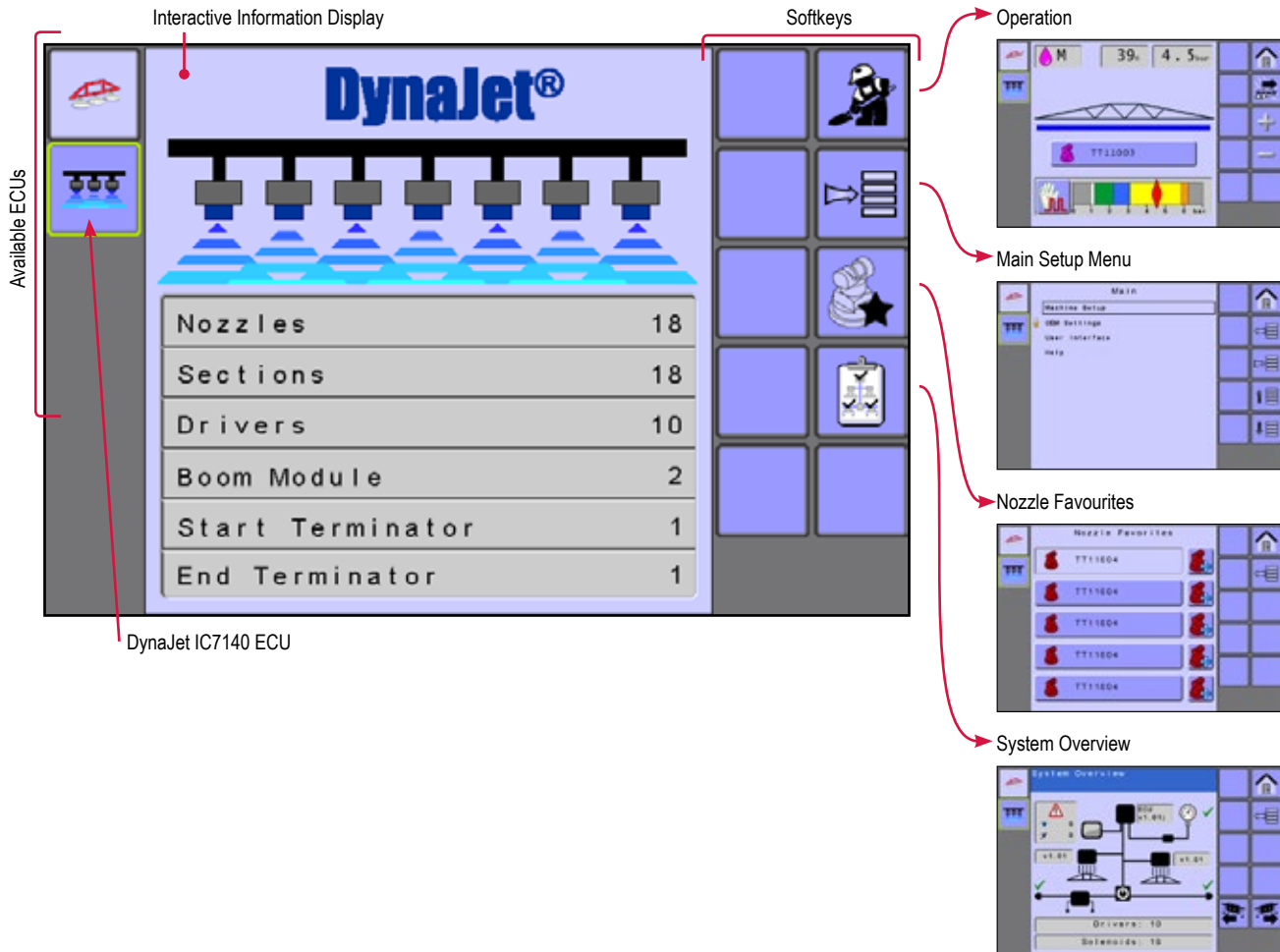



Table 1-1: Initialisation Screen Options

Softkey	Description
Available ECUs	Systems currently available on your UT are displayed in the left hand column of every screen. The highlighted ECU icon indicates the ISOBUS system component that is in focus. To navigate between systems, press the desired system's icon. <i>NOTE: Icons vary depending on systems available components.</i>
 DynaJet IC7140 ECU	Press to access the DynaJet IC7140 system. A progress bar may be shown on the icon during start up while the system loads and communicates with all components.
Interactive Information Display	Displays all system information, menus and operation interactions as well as may contain buttons for additional screen options or settings.
Softkeys	Displays buttons [with or without icons] to access additional menus or screens, to change settings on the current screen and/or to enhance settings or operation functions. Softkeys without an icon do not have associated functions.

Settings Options Navigation

Figure 1-5: Navigating Selection Screens

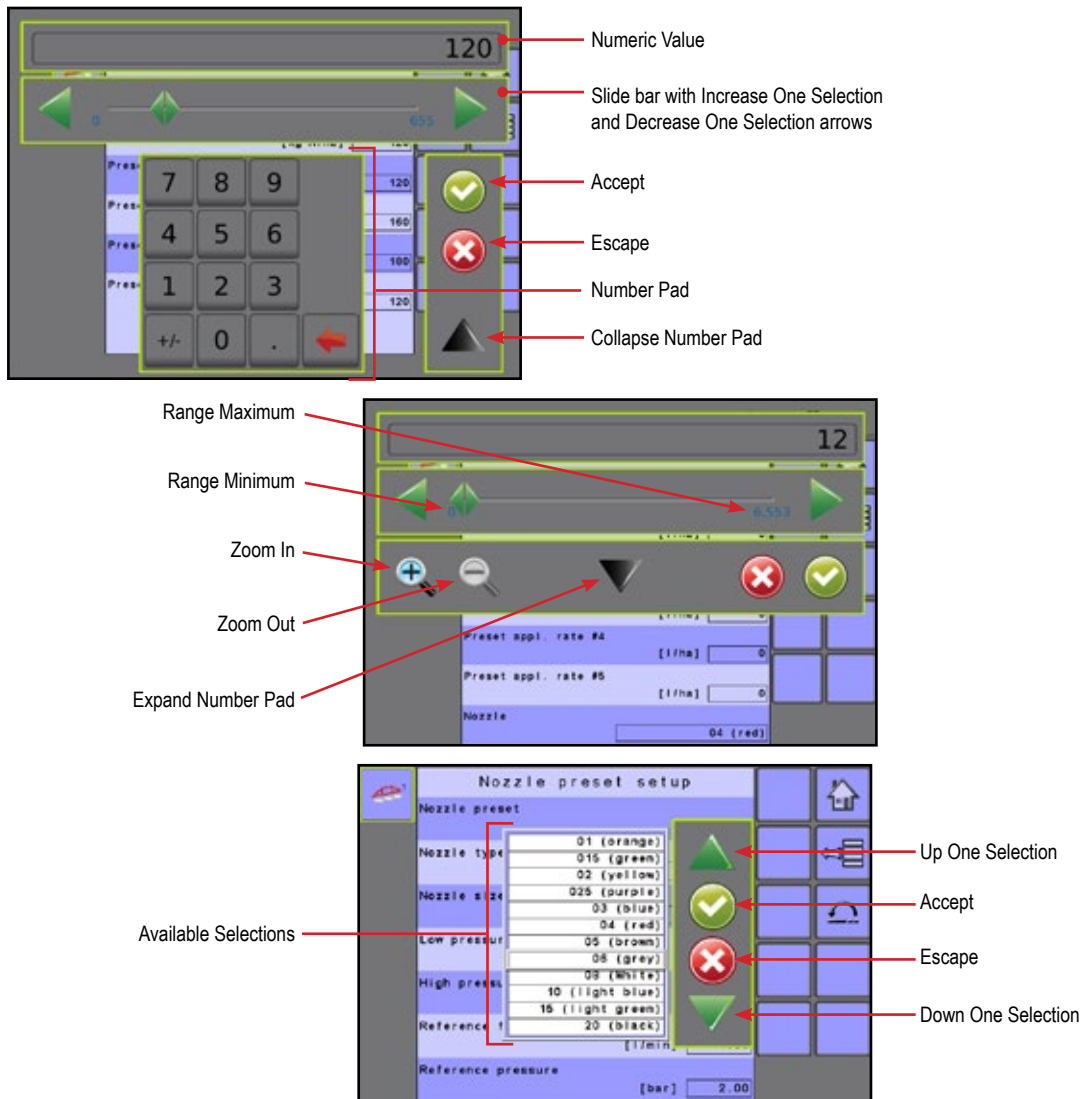

Table 1-2: Settings Options

Section or icon	Description	Section or icon	Description
Numeric Value	Displays the current numeric value	Accept	Accepts and saves settings
Slide Bar	Selects the value by pressing and releasing on the slide bar or pressing and dragging the slider to a designated value. The range for a specific setting is displayed on the slide bar.	Escape	Escapes without saving changes
Slider	Slide to the left to decrease or right to increase the numeric value	Up One Selection Arrow	Moves selection box up
Increase Arrow	Increases the numeric value	Down One Selection Arrow	Moves selection box down
Decrease Arrow	Decreases the numeric value	Zoom In	Narrows slide bar range. Grey = maximum zoom level.
Number Pad	Use to set the numeric value	Zoom Out	Expands slide bar range. Grey = minimum zoom level.
Expand Number Pad	Reveals the number pad		
Collapse Number Pad	Hides the number pad		

CHAPTER 2 – INSTALLATION

DynaJet IC7140 offers two types of installations, standard and hybrid. Standard offers dual output drivers that are moulded into the boom harness and tailored to the customers specific equipment. The hybrid install offers eight (8) output driver options where each driver consists of eight (8) nozzle harnesses.

DYNAJET IC7140 ECU

This section describes the DynaJet IC7140 ECU device.

Figure 2-1: DynaJet IC7140 ECU Top and Bottom Views

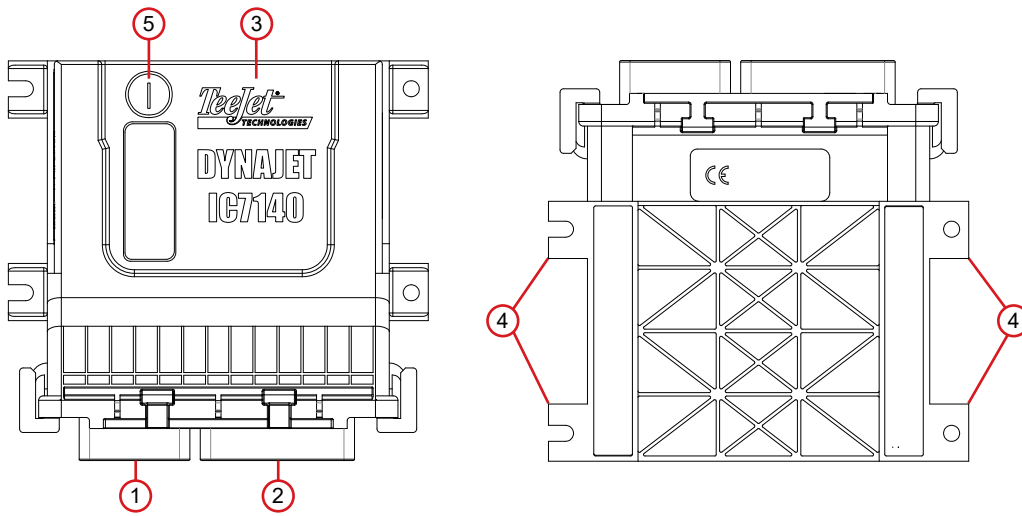

Item	Description
1	Pressure Interface Harness connector
2	DynaJet IC7140 ECU Main Harness connector
3	Product and serial number label
4	Mounting tabs
5	Programming Port

NOTE: Verify the unit is secured with the four mounting screws before using the DynaJet IC7140. Keep magnetic and electromagnetic devices away from the DynaJet IC7140 system. Mounting the DynaJet IC7140 system in areas of high vibration can adversely affect the system operation. It is highly recommended to mount directly to the vehicle's main frame or to something directly connected to the main frame.

ECU Orientation

The DynaJet IC7140 ECU needs to know which orientation it is mounted or the system will not work properly. Note the direction of the ECU label, connections and left/right edges in relation to the forward facing direction of the vehicle. The view will always be as if the operator is looking down from the top of the cab.

- The DynaJet IC7140 ECU must be mounted securely to a surface that is firmly mounted to the vehicle, and moves in unison with the GNSS antenna.
- During DynaJet IC7140 console setup in Main-> OEM Settings the orientation of the DynaJet IC7140 ECU must be accurately specified in “ECU Orientation”.

Orthogonal Orientations

The DynaJet IC7140 ECU is to be mounted orthogonally on the vehicle. This means that the DynaJet IC7140 ECU is at a 90° angle or some multiple of 90 (0, 90, 180, 270) degrees at all three axes (vertically, horizontally, and perpendicular to the other two) when compared to the direction of travel of the vehicle.

Select one of the six (6) possible orthogonal orientations at which the DynaJet IC7140 ECU is installed.

- ◀ Horizontal, Label Up (default installation position)
- ◀ Horizontal, Label Down
- ◀ Vertical, Connectors Up
- ◀ Vertical, Connectors Down
- ◀ Vertical, Left Edge Up
- ◀ Vertical, Right Edge Up

Table 2-3: Orthogonal Orientations as Compared to Vehicle Orientation

Horizontal, Label Up	Horizontal, Label Down	Vertical, Connectors Up	Vertical, Connectors Down	Vertical, Left Edge Up	Vertical, Right Edge Up

Default Installation
Position

STANDARD INSTALLATION

INTRODUCTION

INSTALLATION

INITIAL STARTUP

HOME SCREEN

SETUP

OPERATION

NOZZLE FAVORITES

SYSTEM OVERVIEW

APPENDIX

Power Source

Power must be sourced from the battery using the 60 amp fused cable, 45-05943. Power from the battery is routed to the boom using the 6 gauge power cables DP-xxxx.

The Power Distribution Module (PDM) switches power from the battery to the drivers. The main PDM harness can supply up to 80 nozzles (40 nozzle per side) DP-01. If driving more than 80 nozzles, use PDM DP-02 with an optional Power Extension cable DBP-Lxxxx. PDM model DP-01-R or DP-02-R is for reverse mounting when installing backwards or upside down.

Driver Modules and Terminators

DynaJet IC7140 driver modules DB2-00x-xxx-xxx-xxx are moulded into the boom harness and are tailored to specific nozzle spacing and length. CAN cables are integrated within the Driver Module Harnesses. Because the order of the driver modules is automatically detected upon power-up, harnesses can be changed without reconfiguring.

When installing DynaJet Driver Modules, begin with the Start Terminator DBT-S, or Driver Module with Start Terminator DB2-00x-S-xxx-xxx-xxx, then connect to the PDM, routing from the PDM to the End Terminator DBT-E, or Driver Module with End Terminator DB2-00x-xxx-xxx-E-xxx.

Figure 2-2: Standard Installation

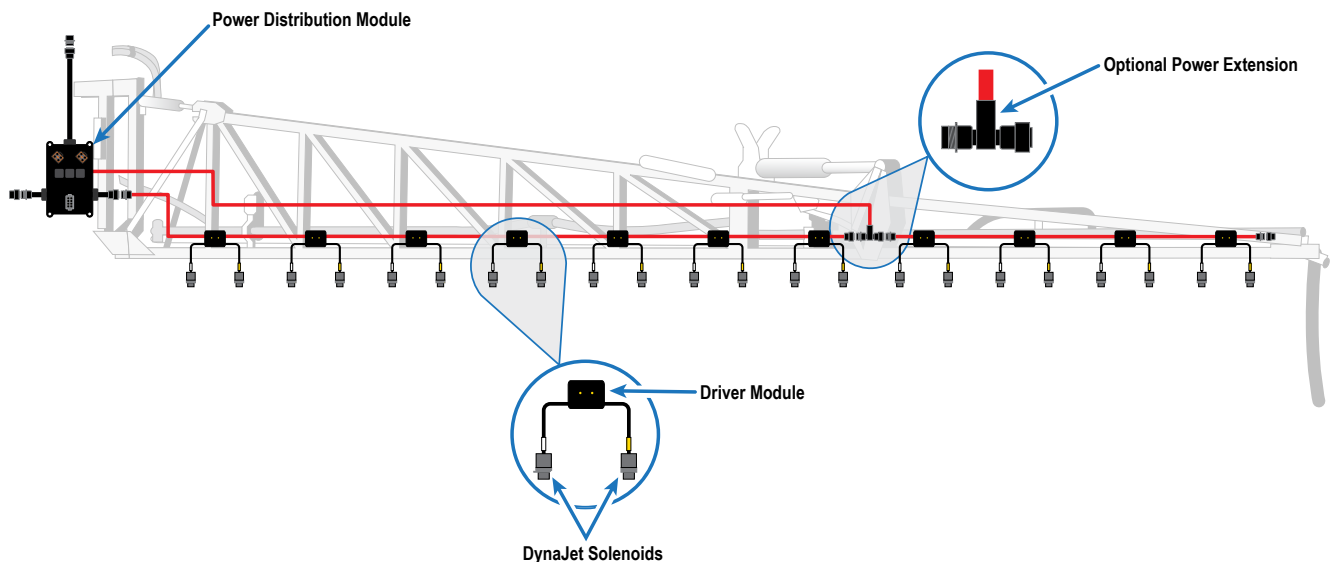

Pressure Interface

Pressure Interface 78-05137 connects directly to the DynaJet IC7140 ECU Module. Extension cables 404-0045 or 404-0039 are used to connect to the pressure sensor on the boom.

Boom Interface Module (BIM)

The BIM harness connects between the DynaJet IC7140 and the PDM. It can be mounted in the cab or outside depending upon your installation.

BIM 78-05091 is used for up to 15 sections (1-15). BIM 78-05128 (optional) is available for systems up to 30 sections (16-30).

On the BIM harness 45-10200 and 45-10204, Boom Sense Wires (or flying leads) connect to existing machine boom section 12V ON/OV OFF outputs.

NOTICE: Turn compensation will not available when the system has two BIMs.

HYBRID INSTALLATION

Power Source

Power must be sourced from the battery using the 60 amp fused cable 45-05943.

Power from the battery must be routed to the boom using the 6 gauge power cables 45-05942-xx.

The Power distribution modules 78-05121-xx must connect to the 45-05942-xx cables.

Power must be routed from 78-05121-xx to each DynaJet IC7140 driver 78-05124 using cables 45-05971-xx, and 45-05997-xx or 45-05998-xx.

Drivers Modules and Terminators

There will be one DynaJet IC7140 driver 78-05124 per eight (8) nozzles.

- Mount each DynaJet IC7140 driver centered within the eight (8) nozzles it controls.

The Start Terminator 45-04006-START must be connected to the DynaJet IC7140 driver 78-05124 for section 1.

The End Terminator 45-04006-END must be connected to the Driver module 78-05124 for the last section.

Nozzle Harnesses

When installing Nozzle Harnesses 45-04005-xx-xx always start with section 1 and continue to the last section.

Nozzle harnesses are designed for your specific nozzle spacing.

Always start with nozzle 1 and work left to right (while facing in the machine's forward direction).

CAN Cables

CAN cables must be connected in series.

Pressure Interface

Pressure Interface 78-05137 connects to the DynaJet IC7140 ECU Module. Extension cables 404-0045 or 404-0039 are used to connect to the pressure sensor on the boom.

Boom Interface Module (BIM)

The BIM harness connects between the DynaJet IC7140 and the PDM.

BIM 78-05091 is used for up to 15 sections (1-15). BIM 78-05128 (optional) is available for systems up to 30 sections (16-30).

On the BIM harness 45-10200 and 45-10204, the Boom Sense wires (or flying leads) are supplied to tie into existing machine boom section 12V ON/OV OFF outputs.

NOTICE: Turn compensation will not available when the system has two BIMs.

Figure 2-3: Hybrid Installation

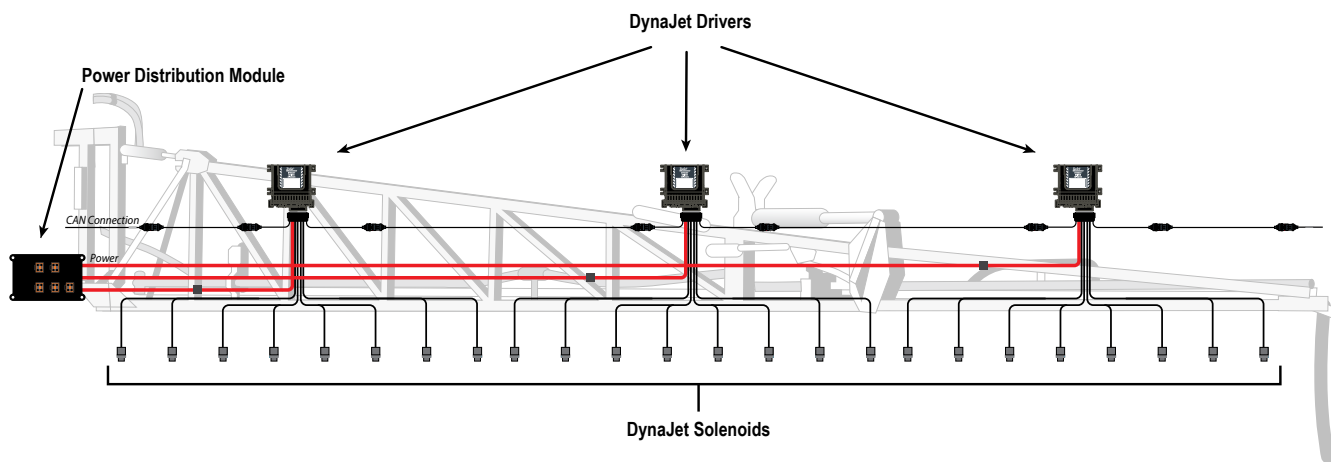

CHAPTER 3 – INITIAL STARTUP & CALIBRATIONS

The following is the steps required for first-time setup of the DynaJet IC7140 system. When these settings and calibrations are completed, operation should be possible.

WARNING! With each nozzle change or when nozzles are replaced, a system calibration (steps 4-7) must be completed before attempted operation. Failure to properly configure and calibrate the system will result in sub-standard performance. Once complete, operation may proceed.

NOTE: Information on the ECU will vary depending on the parameters set by the user and the OEM.

NO. 1 POWER UP AND INITIALISATION

Power is continuously supplied to the controller. The universal terminal (UT) will give access to the controller options and operation.

- The console needs to be cycled off and back on when changing or attaching other or additional electronic components to the system.

Upon startup, the system will cycle the following screens.

- ▶ Initialisation screen – During power-up, the Initialisation screen is displayed for five (5) seconds, or until all drivers are scanned.
- ▶ End User Licence Agreement – appears after the Initialisation screen and will not allow Home Screen access until it has been acknowledged by pressing the Accept button.
- ▶ Home screen – Once initialisation is complete and the End User Licence Agreement is acknowledged, the Home screen will appear. Multiple values are displayed on the Home screen offering a quick overview of the state of the system components.

Figure 3-1: Power Up and Initialisation Sequence

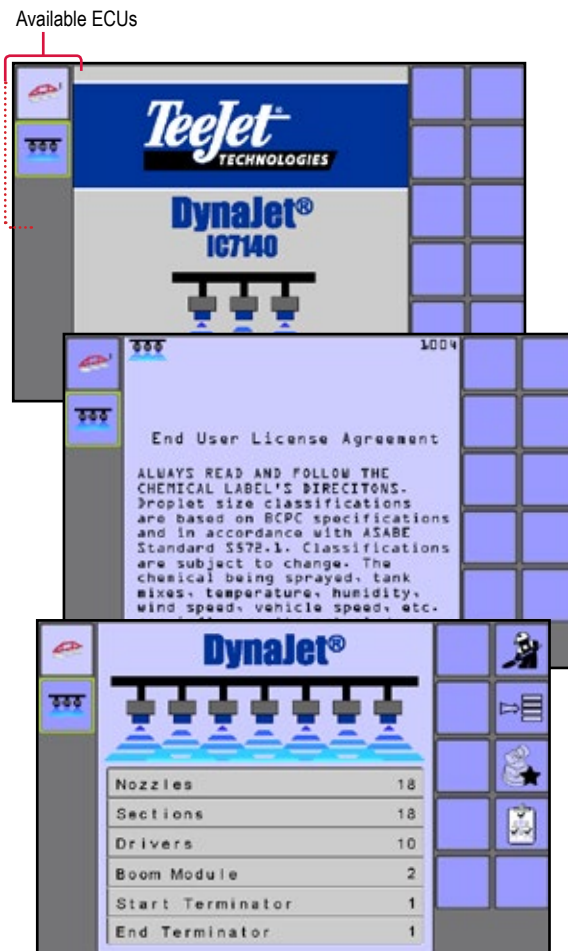

NO. 2 SETUP UP MACHINE

Machine Setup is found in the Main Menu screen. When initially setting up the system, setting parameters for Number of Sections, Nozzles per Section, and Pressure Sensor Max is strongly suggested. Other machine settings and user parameters can be adjusted as needed after calibrating the system.

NOTE: The Machine Setup Parameters need to match the installed nozzle.



1. From the Home screen, press the MAIN SETUP KEY .
2. Select **Machine Setup**.
3. Establish:
 - ▶ Number of Sections – Set the number of boom sections.
 - ▶ Nozzles per Section – Press the Arrow key  to go to the Nozzles per Section Screen. Enter a value for each section.
 - ▶ Pressure Sensor Max – Enter the maximum pressure value as indicated on the pressure sensor label.



Figure 3-2: Machine Setup

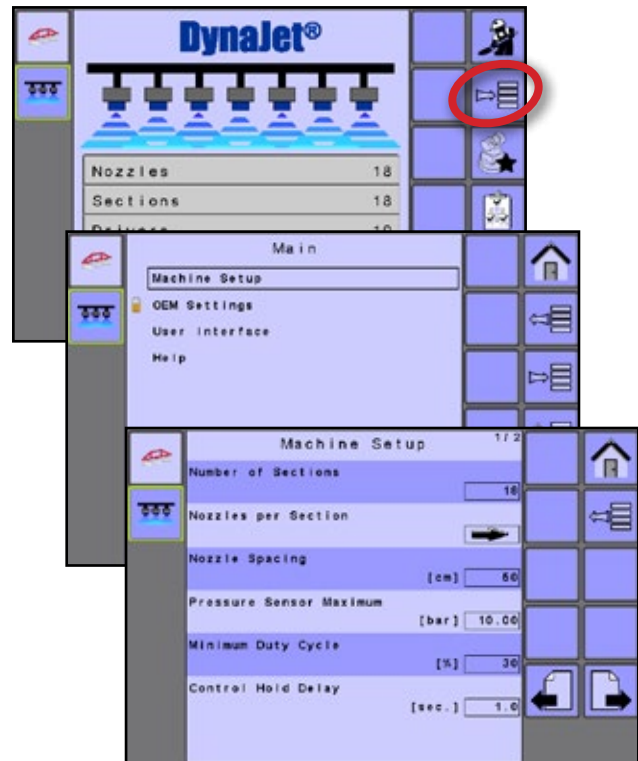

NO. 3 SETUP UP AND SELECT NOZZLE

Preset nozzle favourites allows saving of up to five (5) nozzles for quick recall. Use this to quickly access the most frequently used spray nozzles including those being used for initial startup calibrating.

Establish Nozzle Favourite(s)

1. From the Home screen, press NOZZLE FAVOURITES KEY .
2. Select ADD NOZZLE BUTTON . Nozzle selection will be established in the associated favourites location.
3. On the Nozzle Selection screen,
 - ▶ Select a nozzle series.
 - ▶ Select the nozzle capacity.
4. Press the PREVIOUS SCREEN KEY  to complete the selection and return to the Nozzle Favourites screen.
5. Repeat steps 2-3 to establish additional nozzle favourites.

Select Current Nozzle

If more than one favourite is established:

1. Select the nozzle to be used during the System Functional Test.

Figure 3-3: Nozzle Selection

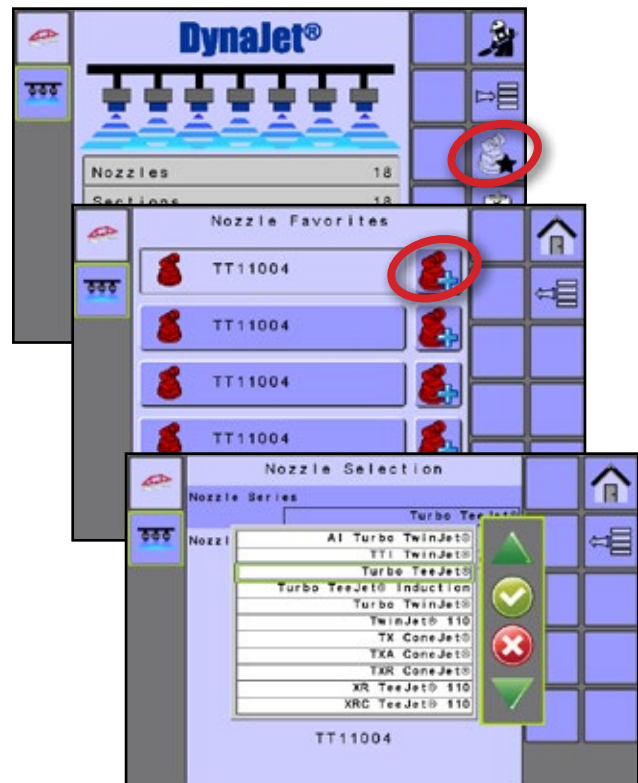

NO. 4 GET TO KNOW THE CONTROL MODES

To begin calibrating the system, an operation mode needs to be established. There are three types of Operation Modes:



Manual Mode – Select the intended nozzle and the target PWM Duty Cycle Percentage. The system will calculate and display the droplet sizes for the nozzle selected. DynaJet IC7140 will control to the target Duty Cycle Percentage.



Droplet Mode – Select the intended nozzle and the target droplet size range. The system will calculate and display the median boom pressure required to meet this droplet size range for the nozzle selected. DynaJet IC7140 will control to maintain the target droplet size range.



Pressure Mode – Select the intended nozzle and the target boom pressure. The system will calculate and display the droplet size for the nozzle selected at the target boom pressure. DynaJet IC7140 will control to maintain the target boom pressure.

NOTE: Many factors including but not limited to application rate, material density, speed, nozzle model/size/spacing may limit the ability of DynaJet IC7140 to meet the control target.

To select an operation mode:

1. From the Home screen, press the OPERATION KEY .
2. Press the CURRENT OPERATION MODE INDICATOR & MODE CHANGE BUTTON on the Nozzle Pressure Gauge. Modes will toggle from Manual Mode to Droplet Mode to Pressure Mode.



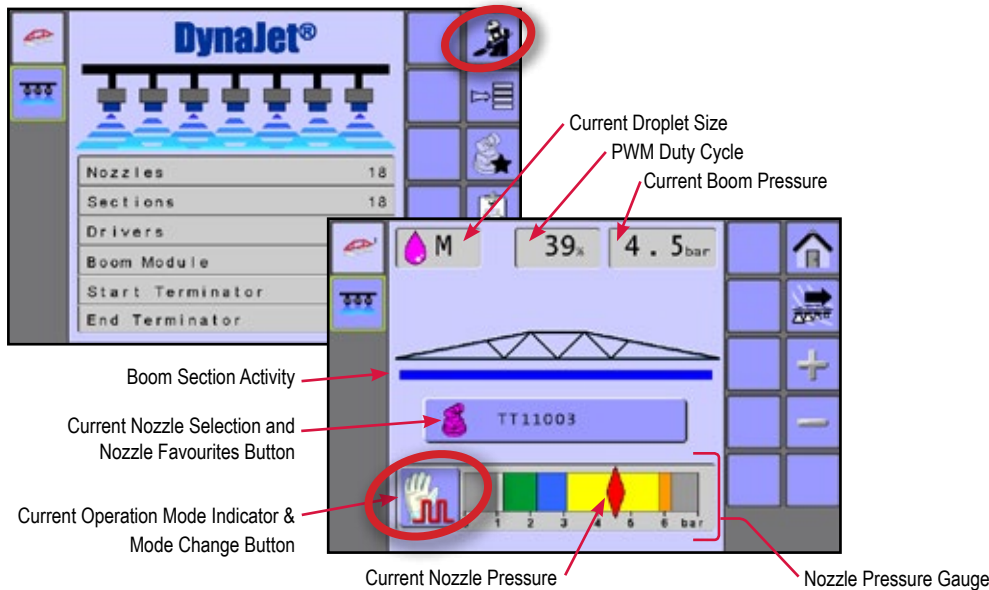

Figure 3-4: Operation Mode from Home Screen



See the “Operation” chapter for more details on each mode.

NO. 5 PREFORM SYSTEM FUNCTIONAL TEST

The following is instructions for performing a functional test of the system.

- Ensure that current rate control system is operating normally prior to attempting to use the DynaJet IC7140.
 1. On the UT, bring DynaJet IC7140 into focus, navigate to the Operation screen .
 2. Set DynaJet IC7140 operating mode to Manual Mode .
 3. Using the PWM INCREASE KEY , set PWM duty cycle at 100%. This will make the system operates as if DynaJet IC7140 was not present.
 4. Use this configuration to verify the rate control system is operating normally.
- Confirm boom section functionality.
 1. Continue operating DynaJet IC7140 in Manual Mode .
 2. Using the PWM DECREASE KEY , set PWM duty cycle to 50%.
 3. Switch the master switch ON (on rate controller or other boom section control switches)
 4. Using the switch box, turn ON each section verifying the proper section turns blue on the DynaJet IC7140 operation screen.
 5. Turn the master switch OFF. On the the DynaJet IC7140 operation screen, verify all sections are now grey.
- Confirm each of the corresponding e-ChemSaver Solenoids is impulsing.
 1. Verify that the pressure on the mechanical gauge is close to the digital pressure display on the DynaJet IC7140 operation screen.

NOTE: Due to mechanical losses the sensors will not be an exact match. Enter the maximum pressure value as indicated on the pressure sensor label.

This confirms the basic functionality of the DynaJet IC7140 system. Further details for fine-calibrating the system are in “Calibrate the DynaJet IC7140 System” section of this guide.

NO. 6 CALIBRATE THE RATE CONTROLLER REGULATION

The following procedure determines the most aggressive rate controller regulation valve gain that will work over all pressure ranges.



Before you begin:

- Ensure product pump is providing flow greater than the maximum demand of the system. Consult sprayer manufacturer specifications.
- Understand that the most aggressive value will be found by increasing valve gain until system oscillates and then decreasing the setting until the system is stable at that value.

NOTE: Other rate controller specific settings may apply based on your specific rate controller system
- The rate controller must be operating in automatic mode during these tests.
- To attain the minimum and maximum operating pressures for the specific nozzle in use under each test condition the user must be able to either: adjust the target application rate, or adjust the machine speed

Flow Impulses Tests

The following tests will confirm that impulse of flow through the solenoids will not affect rate controller stability even when duty cycle is below 50%.

1. Set DynaJet IC7140 operating mode to Manual Mode .
2. Using the PWM INCREASE and DECREASE KEYS  , set PWM duty cycle as noted in each test.
3. Perform tests as specified in the following sections, taking note of the pressure levels during each test.
4. Set rate controller valve gain to the highest value that will work with all three of the following tests. This will be the lowest gain value found in the 3 tests. Once established, this value should not need to be changed again.

If the system does not control acceptably with this gain value at all manual duty cycle settings, then something is wrong with the system that needs to be resolved before trying to calibrate the DynaJet IC7140 System. For assistance, contact TeeJet Technologies Customer Support or an authorised TeeJet Technologies dealer if additional support is required.

Test 1 – Duty Cycle 100%

1. Start by setting DynaJet IC7140 duty cycle to **100%**.

Test 1A – Minimum Operating Pressure

2. Determine rate controller gain value with operating pressure at MINIMUM.
3. Reduce target rate or machine speed until system reaches the minimum operating pressure.
4. Adjust the gain value until stable.

Controller gain value at minimum pressure: _____

Test 1B – Maximum Operating Pressure

5. Set rate controller gains values with operating pressure at MAXIMUM.
6. Increase target rate or machine speed until system reaches the maximum operating pressure.
7. Adjust the gain value until stable.

Controller gain value at maximum pressure: _____

Test 2 – Duty Cycle 50%

1. Start by setting DynaJet IC7140 duty cycle to **50%**.

Test 2A – Minimum Operating Pressure

2. Set rate controller gains/values with operating pressure at MINIMUM.
3. Reduce target rate or machine speed until system reaches the minimum operating pressure.
4. Adjust the gain value until stable.

Controller gain value at minimum pressure: _____

Test 2B – Maximum Operating Pressure

5. Set rate controller gains/values with operating pressure at MAXIMUM.
6. Increase target rate or machine speed until system reaches the maximum operating pressure.
7. Adjust the gain value until stable.

Controller gain value at maximum pressure: _____

Test 3– Duty Cycle “Minimum Duty Cycle”

1. Start by setting DynaJet IC7140 duty cycle set to “Minimum Duty Cycle” value (default is 30%)

Test 3a

2. Set rate controller gains/values with operating pressure at MINIMUM.
3. Reduce target rate or machine speed until system reaches the minimum operating pressure.
4. Adjust the gain value until stable.

Controller gain value at minimum pressure: _____

Test 3b

5. Set rate controller gains/values with operating pressure at MAXIMUM.
6. Increase target rate or machine speed until system reaches the maximum operating pressure.
7. Adjust the gain value until stable.

Controller gain value at maximum pressure: _____

NO. 7 CALIBRATE THE DYNAJET IC7140 SYSTEM

Coarse gain will be increased until the system is oscillating across the target pressure. Once that is occurring, then fine gain will be increased to smooth/eliminate the oscillation.

- A coarse gain too low will cause the system to be stable but slow to get on target.
- A coarse gain too high will cause the system to overshoot the target range when a speed change happens.
- A fine gain too low will allow the system to continue to oscillate.
- A fine gain too high will cause the system to oscillate too rapidly and cause a thumping in the system.
- The lower the target pressure, the higher the fine gain can be set, so calibrating needs to be done at highest pressure/smallest droplet size that the machine will typically be operating.
- Speed changes will be required for the best calibrating possible.
- Simulated speed changes are preferred, but driving the machine is acceptable.
- Steady speeds are required.



1. From the Main Setup screen , select **Machine Setup**.

Figure 3-5: Machine Setup – Course Gain and Fine Gain



Calibrating the System

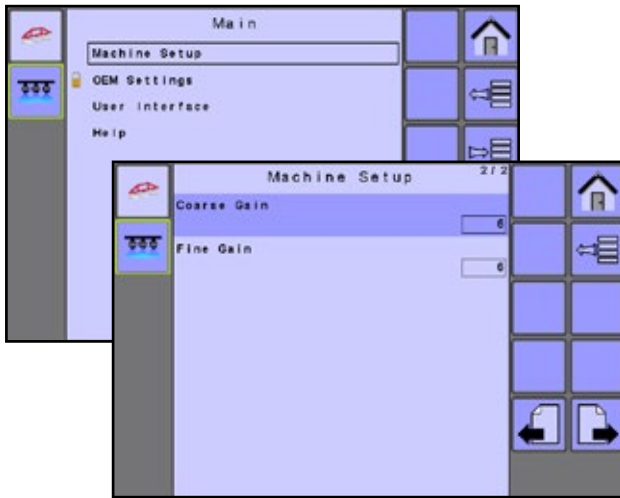



The following steps will use the DynaJet IC7140's coarse and fine gain settings to calibrate the system:

1. Set DynaJet IC7140 to Droplet Mode .
2. Choose the nozzle being used from the Nozzle Favourites screen .
3. In Main Setup-> Machine Setup page 2, set Coarse Gain to **2** and Fine Gain to **2**.
4. In Main Setup-> OEM Settings page 1, disable Jump Point by setting value to **0**.
5. Run Highest Pressure/Smallest Droplet Size configuration.
6. Notate Course Gain and Fine Gain values for reference with Lower Pressure/Larger Droplet Size verification.
7. Run Lower Pressure/Larger Droplet Size verification.
8. In Main Setup-> OEM Settings page 1, enable Jump Point by setting value to **0.35 bar / 5 psi**.

If more than one nozzle size is going to be used on the machine, then run a test with the same values for coarse gain and fine gain for the other nozzles. Always check at the highest pressure/smallest droplet size that will typically be used.

Highest Pressure/Smallest Droplet Size

Calibrate Course Gain

1. On the Operation screen, using the Droplet Size Keys , choose the highest pressure/smallest droplet size that will typically be used by disabling Droplet Size Keys .
 - Example:  to .
2. Run the system and view on the DynaJet IC7140 the Current Nozzle Pressure diamond on the Nozzle Gauge when changing speed.
3. Increase the coarse gain until system is oscillating across the target pressure. Most machines operate with a setting between 4 to 6 for coarse gain.





Course Gain value at highest pressure/smallest droplet size: _____

Calibrate Fine Gain

4. Using the same speed changes as before, view the Current Nozzle Pressure diamond on the Nozzle Gauge when changing speed
5. Begin increasing fine gain until the oscillations stop and the target rate and target pressure are stable. Most machines operate with a setting between 8 to 12 for fine gain.

Fine Gain value at highest pressure/smallest droplet size: _____

Lower Pressure/Larger Droplet Size

6. After coarse gain and fine gain have been set, using the Droplet Size Keys , choose a lower pressure/larger droplet size that will typically be used by disabling Droplet Size Keys .
 - Example:  to .
7. Run the system using the same speed changes and view on the DynaJet IC7140 the Current Nozzle Pressure diamond on the Nozzle Gauge when changing speed.

Typically, the settings will not have to be changed for the lower pressure applications.

CHAPTER 4 – HOME SCREEN

 The Home screen gives access to the DynaJet IC7140's available functions.

NOTE: Information on the ECU will vary depending on the parameters set by the user and the OEM.

Figure 4-1: Home Screen

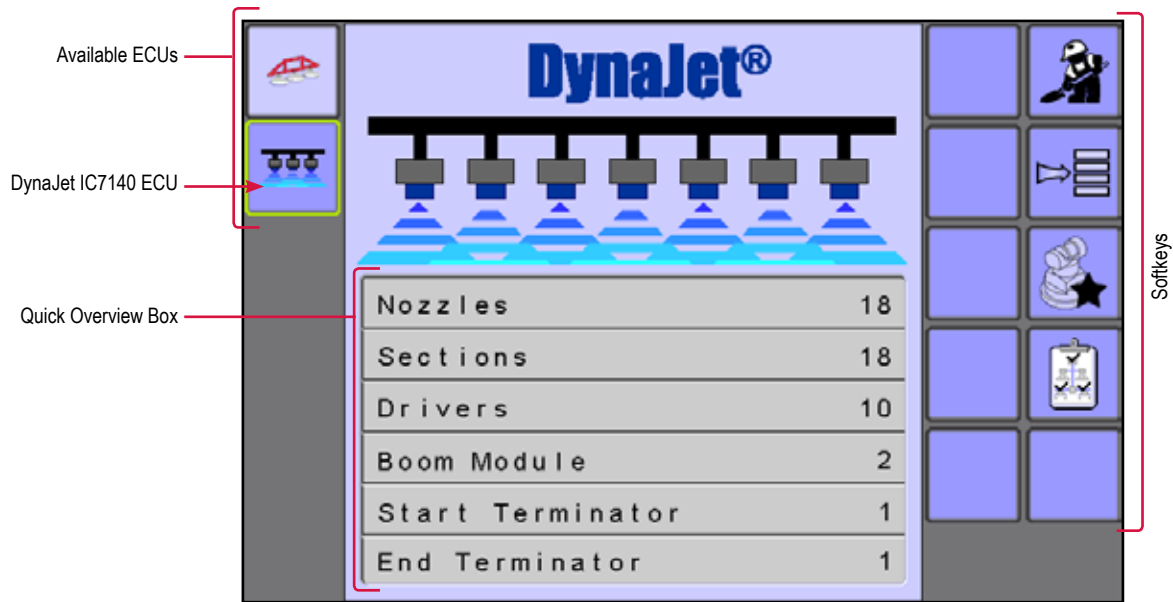







Table 4-4: Home Screen Options

Softkey	Description
Available ECUs	Use to navigate between systems currently available on your UT. The highlighted ECU icon indicates the ISOBUS system component that is in focus. <i>NOTE: Icons vary depending on systems available components.</i>
 DynaJet IC7140 ECU	Press to access the DynaJet IC7140 system. A progress bar may be shown on the icon during start up while the system loads and communicates with all components.
 Operation Mode	Press to access the Operation screen of the DynaJet IC7140 system
 Operation Mode Not Available	Shown when the Operation screen is not available due to an error
 Main Setup Menu	Accesses the main setup menu to input various control settings
 Nozzle Favourites	Press to access the Nozzle Favourites screen to preset up to five (5) nozzles and select the current nozzle
 System Overview	Press to access the System Overview screen to locate any problems as well as give information on selected drivers or solenoids
Quick Overview Box	Displays a quick overview of the state of the systems components

Quick Overview Box

The Quick Overview section on the Home screen displays several values to alert the user of the state of the system. The following set of information will inform the user of the current implement status and signify any issues by displaying an alert.

Information displayed in the quick overview:

- Nozzles – number of nozzles
- Sections – number of sections
- Drivers – number of drivers
- Boom Module – number of boom modules
- Start Terminator – number of start terminators
- End Terminator – number of end terminators

Use the System Overview key  to get more details on the system components.

Figure 4-2: System Overview Example



See the “System Overview” chapter for more details.

Initialisation Errors

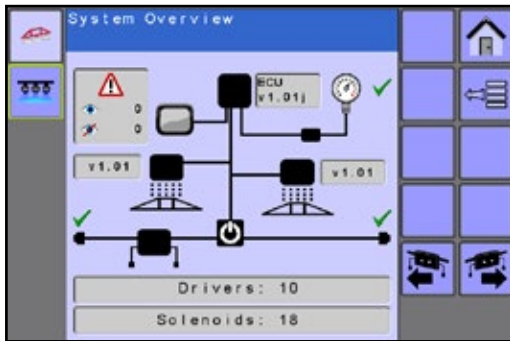
Initialisation errors appear on the Home screen to alert the operator of certain issues and prevent the console from entering operation mode until rectified.

- Nozzles – Boom Setup Error due to the number of nozzles on the sprayer does not match the DynaJet IC7140
- Sections – Number of Sections Error due to the number of sections on the sprayer does not match the DynaJet IC7140
- Drivers – Missing Driver Error due to at least one driver is not present on the sensor BUS
- Boom Module – Boom Interface Module (BIM) Error due to communication to a BIM has been lost
- Start Terminator – Start Terminator Error due to the start terminator not detected
- End Terminator – End Terminator Error due to the end terminator not detected

Figure 4-3: Quick Overview Error Example

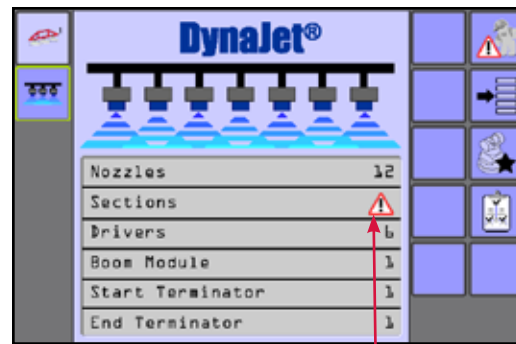

Example of an Initialisation Error



Use the System Overview key  to get more details on the offending system component which is displayed in red with an error icon.

Figure 4-4: System Overview Error Example

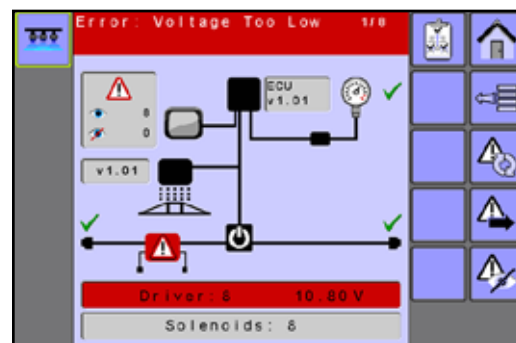

See the “System Overview” chapter or “Appendix C – Troubleshooting Guide” for more details.

CHAPTER 5 – MAIN SETUP

 The main setup menu configures machine setup, OEM options, user interface options and accesses the help menu including diagnostics screens.

NOTE: The menu structure on your display might vary from the one displayed in this User Manual depending on the UT being used. This user manual will display all possible options.

Figure 5-1: Main Setup Screen Overview

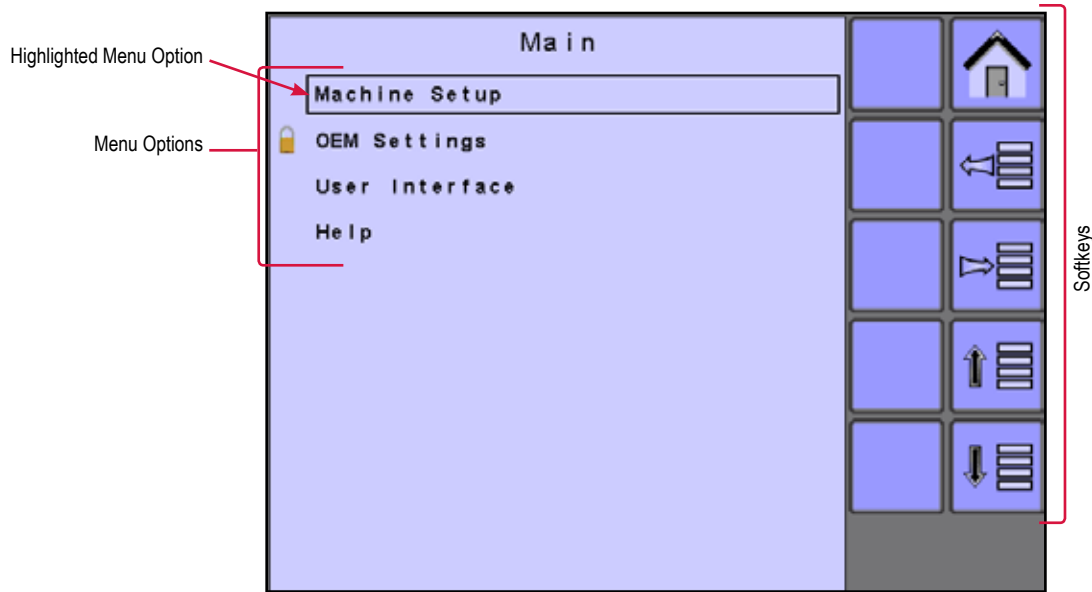







Table 5-5: Main Setup Overview Options

Softkey	Description
Menu Options	Displays the main setup menu options: <ul style="list-style-type: none"> ▶ Machine Setup – used to configure machine settings ▶ OEM Settings – used to configure additional machine settings (menu is password protected and the settings in this menu are directly related to the fitted OEM equipment) ▶ User Interface – allows the operator to select the section beep setting and preferred universal terminal (UT) ▼ Help – allows the operator to view system information <ul style="list-style-type: none"> ▶ About – provides information on the console and modules ▶ System Overview – used to display an overview of select system elements to assist in troubleshooting and diagnosing any operating issues of the system and booms ▶ UT Data Diagnostics – The UT Data Diagnostics screen provides information regarding the virtual terminal controller ▶ Gyroscope Diagnostics – The Gyroscope Diagnostics screen provides information regarding the gyroscope
 Home	Press to go to the Home screen
 Back One Screen	Press to return to the Home screen

	Forward One Screen	Press to go to the highlighted menu option's screen
	Up One Selection	Press to highlight the next option up on the menu
	Down One Selection	Press to highlight the next option down on the menu

Accessing the Main Setup Screen

The Main Setup Screen can be accessed from the Home screen.

Home Screen

1. Press the MAIN SETUP SCREEN KEY .

Figure 5-2: Main Setup Screen – from Home Screen



MACHINE SETUP

Machine Setup is used to configure machine settings.

WARNING! With each nozzle change or when nozzles are replaced, a system calibration (steps 4-7 in the "Initial Startup & Calibrations" chapter) must be completed before attempted operation. These configurations may affect Coarse Gain and Fine Gain settings. Failure to properly configure and calibrate the system will result in sub-standard performance.

1. From the Main Setup screen , select **Machine Setup**.

Figure 5-3: Machine Setup

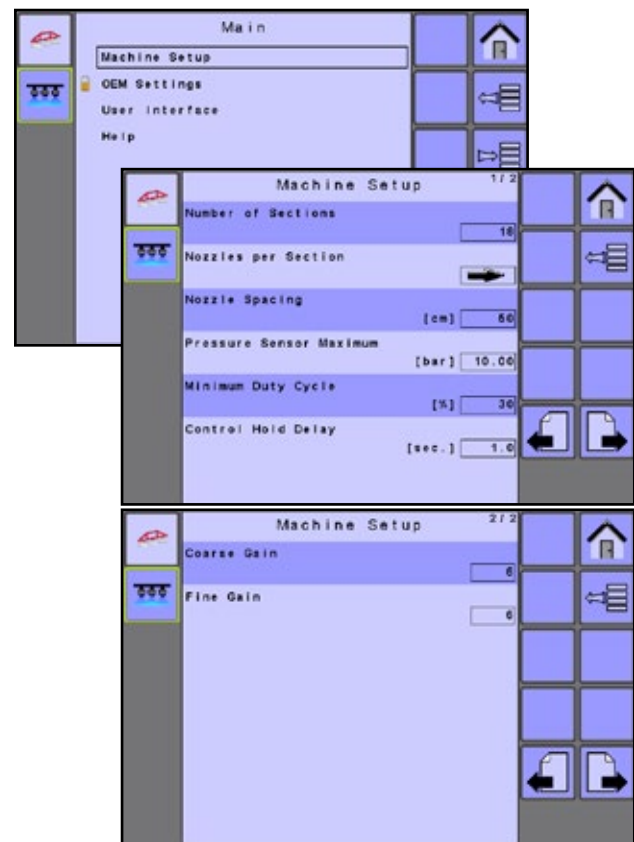

Number of Sections

Sets the number of boom sections.

Nozzles per Section

Sets the number of nozzle locations for each boom section. Sections are numbered from left to right while facing in the machine's forward direction.



1. Select NOZZLES PER SECTION ARROW .
2. Establish the number of nozzles for each available section.

Figure 5-4: Nozzles per Section

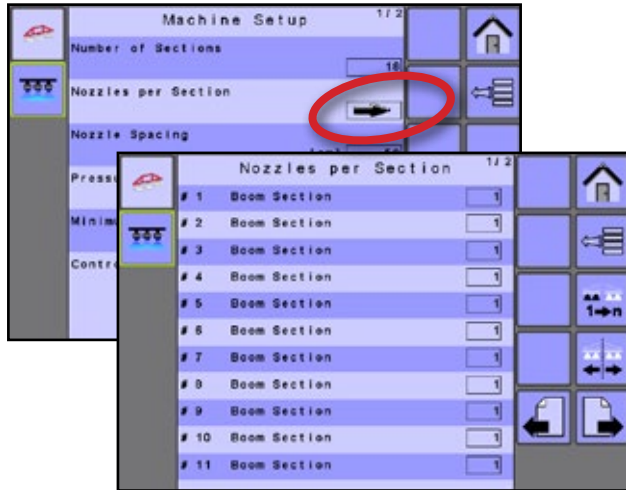

Use these softkeys to assist in establishing settings:

 Equal Number of Nozzles – Press to set all sections to have the same number of nozzles as the value set for Section 1

 Symetric Sections – Press to establish if sections are paired and therefore share the same nozzles per section. Sections on right will be mirrored with sections on left.

Nozzle Spacing

Sets the spacing measurement between nozzles.

NOTE: To prevent the application rate from being wrong, the nozzle spacing multiplied by the number of nozzles must match the section width.

Pressure Sensor Maximum

Sets and verifies the Pressure Sensor Maximum value by looking at the maximum pressure printed on the pressure sensor.

Minimum Duty Cycle

Sets the Minimum Duty Cycle percentage to which DynaJet will control.

Control Hold Delay

When any boom switch changes state, DynaJet will not make control adjustments for the specified time period.

Coarse Gain

This is the more aggressive gain setting and will have the largest impact on the stability and function of the DynaJet system. Coarse Gain makes major adjustments to the duty cycle attempting to bring the actual pressure back to the target. A Coarse Gain setting that is too high will result in pressure oscillation.

Fine Gain

Allows the control system to make minor adjustments when close to the target, with the goal of stable pressures and minimal overshoot of target.

OEM SETTINGS

OEM Settings are used to configure additional controller settings. The OEM Settings menu is password protected and the settings in this menu are directly related to the fitted OEM equipment. Contact the manufacturer or local dealer for service and access code.

1. From the Main setup screen , select **OEM Settings**.
2. Select the access code entry box to the right of the menu option.
3. Use the number pad or slide bar to enter the access code.

Contact the manufacturer or local dealer for access code.

4. Select the ACCEPT KEY  to complete the unlock process
5. Select from:

- ▶ PWM Frequency – The repetition rate of the PWM signal. The frequency can be adjusted from 5Hz to 25Hz (5 to 25 times per second) in 1Hz increments. Increasing the frequency gives less time between skips when solenoids are off but decreases the adjustable flow rate range due to the fixed on and off times of the solenoids. Adjusting the “PWM Frequency” also adjusts the size of the “256 PWM Counts” used to time a lot of the OEM Settings values.
- ▶ On Impulse Duration – During the “On Impulse” (the beginning of each PWM Frequency Cycle), the solenoids are turned on full power, without any “Hold Current” power saving impulses. The “On Impulse Duration” value controls how many of the “256 PWM Counts” are assigned to the “On Impulse”. Increasing the number of counts makes the “On Impulse” bigger. Since adjusting the PWM Frequency higher shortens the “On Impulse”, the value of the “On Impulse Duration” may need to be increased if the solenoids fail to open at higher PWM Frequencies.

- ▶ **Hold Current Frequency Adjustment** – Adjusts how many of the “256 PWM Counts” are assigned to the “Hold Current Frequency”, which controls the frequency of the “Hold Current” impulses. The “Hold Current” impulses are used to reduce the power dissipated by the solenoid. Turning on and off the drive to the solenoids lowers the overall current to the solenoid down to the hold current value. The “Hold Current” value is what it takes to keep the solenoid open but is much less than the current needed to turn the solenoid on.
- ▶ **Hold Current Duty Cycle** – Adjusts how many of the “256 PWM Counts” are in the “Hold Current Duty Cycle”, which controls the off time of the “Hold Current” impulses. Increasing the “Hold Current Duty Cycle” off time impulses reduces the power dissipated by the solenoids. Controlling the duty cycle the solenoid drive allows the lowering of the overall current down to the solenoid hold current value. The hold current value is what it takes to keep the solenoid open but is much less than the current needed to open the solenoid. With “Hold Current Frequency” counts of 10 and “Hold Current Duty Cycle” counts of 5, the “Hold Current” duty cycle is 50%, which cuts the solenoid current about in half.
- ▶ **Phase Offset** – Controls how long after the “Odd Nozzles On Impulse” starts that the “Even Nozzles On Impulse” is delayed. Since there is “256 PWM Counts” per “Frequency Cycle” the count of 128 is a 50% phase offset. If the value was set to 0 then odd and even nozzles would impulse at the same time.
- ▶ **Jump Point** – The pressure rate of change value that is used as a trigger point that will cause the PWM duty cycle percent to jump to 100% if the trigger point is reached.
- ▶ **Maximum Duty Cycle** – Sets the duty cycle at which the pressure control is considered to be at its maximum.
- ▶ **PWM Off Time** – Controls the size of the “Off Pulse” generated at the end of the “Duty Cycle %”. The “Off Pulse” reduces the time it takes for the solenoid to close. The units are tenths of a millisecond, so a value of 20 equals 2.0 milliseconds.
- ▶ **Low Voltage Limit** – Establishes the limit for the lowest allowed voltage for the drivers.
- ▶ **High Voltage Limit** – Establishes the limit for the highest allowed voltage for the drivers.
- ▶ **Low Amps Limit** – Establishes the limit for the lowest allowed current for the solenoids.
- ▶ **High Amps Limit** – Establishes the limit for the highest allowed current for the solenoids.
- ▶ **High Pressure Alarm** – Establishes the system’s high pressure level at which an alarm will activate.
- ▶ **Droplet Size Damping** – Adjust how fast the pressure bar graph indicator on the operating screen responds to changes in pressure.

- ▶ **ECU Orientation** – Select one of the six possible orthogonal orientations at which the DynaJet IC7140 ECU is installed. This means that the ECU is at a 90° angle or some multiple of 90 (0, 90, 180, 270) degrees at all three axes (vertically, horizontally, and perpendicular to the other two) when compared to the direction of travel of the vehicle.

Note the direction of the ECU label, connections and left/right edges in relation to the forward facing direction of the vehicle. The view will always be as if the operator is looking down from the top of the cab.

Figure 5-5: OEM Settings

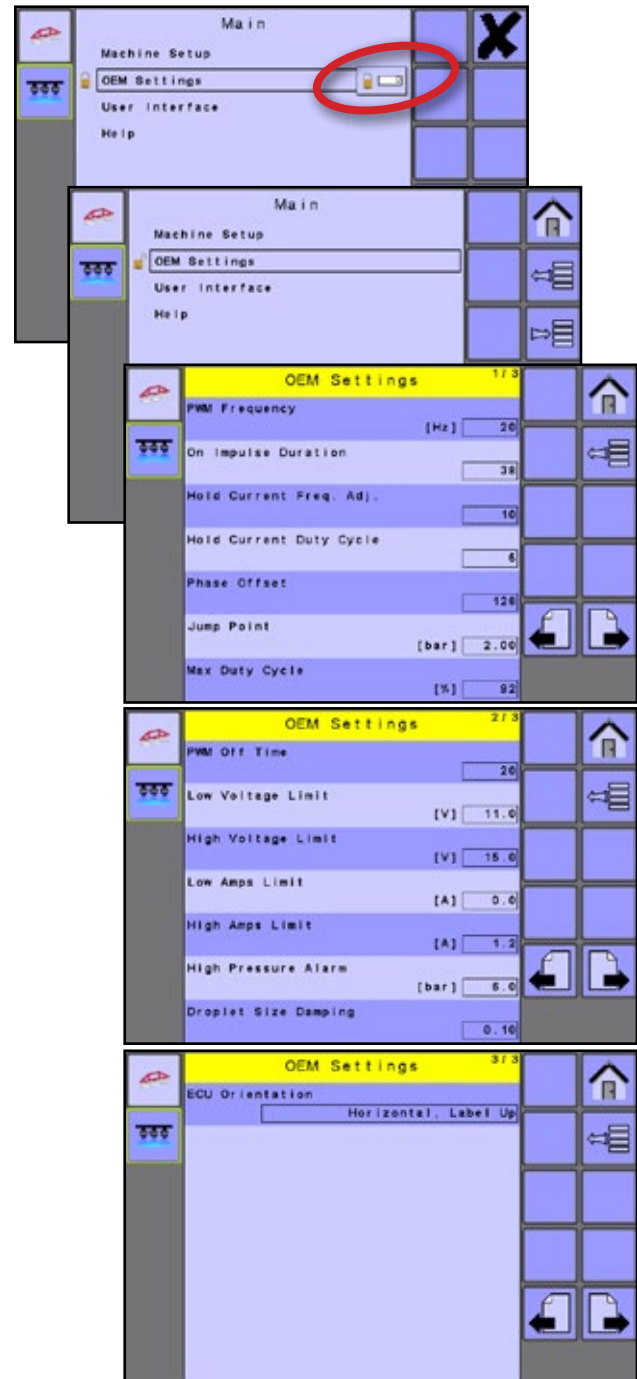

USER INTERFACE

User Interface settings allow the operator to set the preferred UT, boom section beep, and Turn Compensation Visual.

1. From the Main setup screen , select **User Interface**.

Figure 5-6: User Interface



Use Preferred UT

Sets the universal terminal (UT) preference.

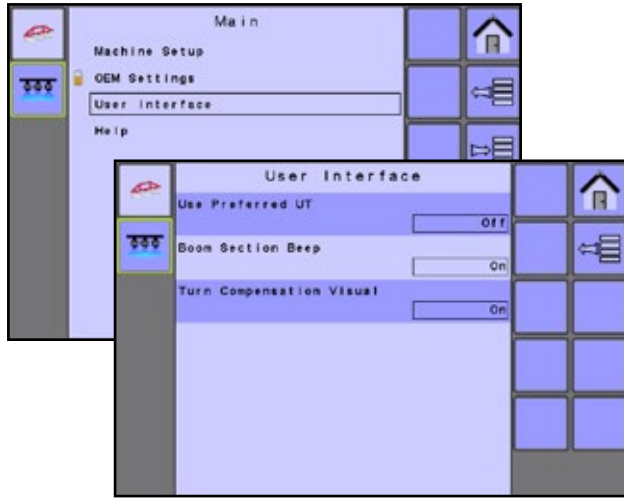
- ▶ If more than one UT is available on the ISOBUS CAN,
 - Select **On** to use the current UT
 - Select **Off** to use a different UT on the ISOBUS CAN
- NOTE: If all UTs are set to "Off", the system will arbitrarily select which UT to use.*
- ▶ If only one UT is available, select **Off**

NOTE: This should always be set to "Off" unless another UT is on the CAN bus.

Boom Section Beep

Enables/disables beep when a boom section is turned on or off.

Turn Compensation Visual

Enables/disables the turn compensation visual graph on the operation screens.

HELP

The Help menu allows the operator to view system information, UT Diagnostics and Gyroscope Diagnostics; and enter the System Overview.

1. From the Main setup screen , select **Help**.
2. Select from:
 - ▶ About – provides information on the console and modules
 - ▶ System Overview – used to display an overview of selected system elements to assist in troubleshooting and diagnosing any operating issues of the system and booms
 - ▶ UT Data Diagnostics – provides information regarding the virtual terminal controller
 - ▶ Gyroscope Diagnostics – provides information regarding the gyroscope

Figure 5-7: Help



About

The About screen displays version or serial number data for all modules found on the DynaJet IC7140 system.

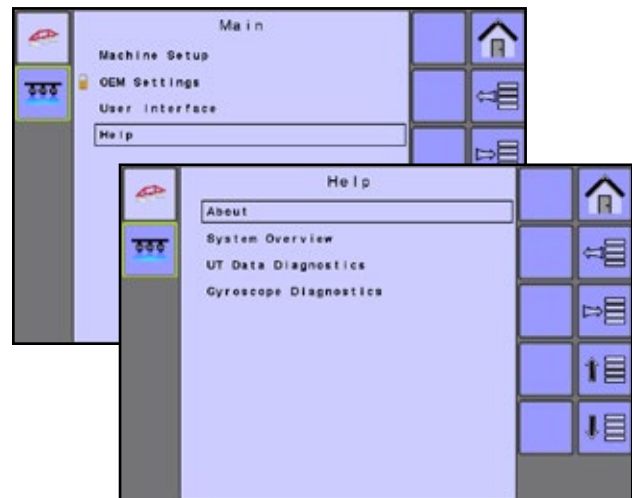
- Software Version
- ECU Board Serial Number
- Boom Interface Versions
- Drivers
- BUS ID ISO Number
- ISO 11783 OEM Name
- ISO 11783 Manufacturer Code

Figure 5-8: About

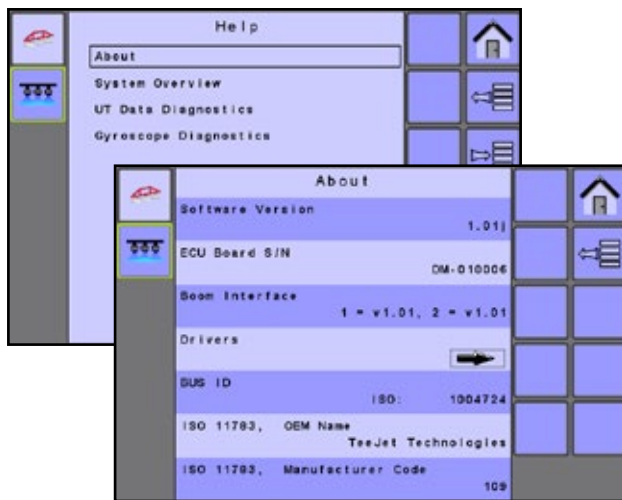

Drivers

The Drivers screen displays ECU software version, serial number, and data for all drivers found on the DynaJet system.

1. Select DRIVERS ARROW .

Figure 5-9: About -> Drivers

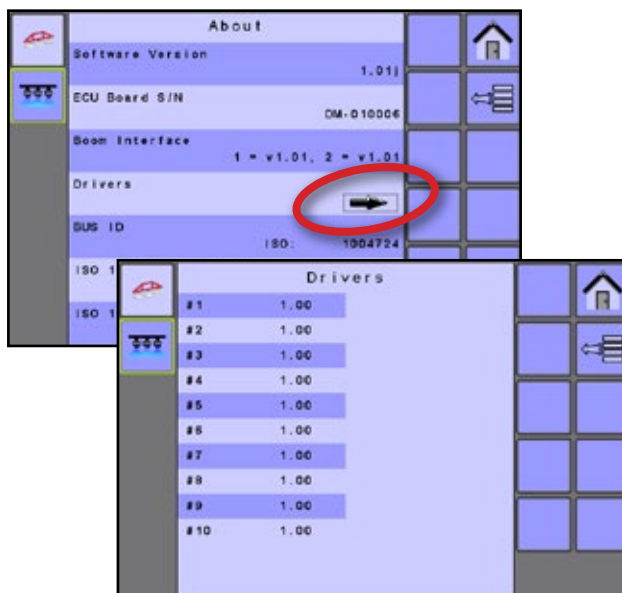

System Overview



Displays system graphically to help the operator locate any problems as well as give information on selected drivers or solenoids.

See the "System Overview" chapter for details.

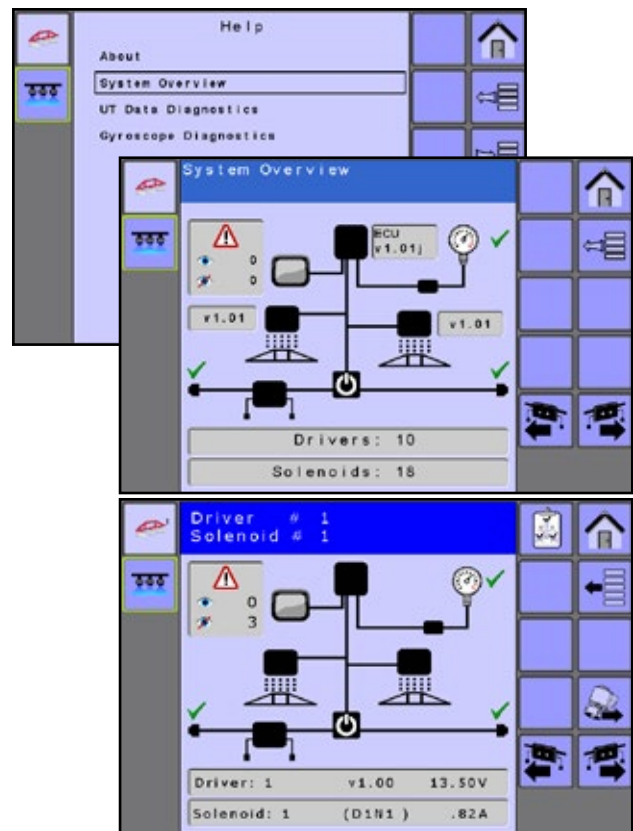
Figure 5-10: System Overview



Use these softkeys to navigate through the drivers and solenoids:

-  Next Driver – Press to access the next driver on the next screen
-  Previous Driver – Press to access the previous driver on the previous screen
-  Next Solenoid – Press to view the next solenoid on the selected driver

UT Data Diagnostics

Provides information regarding the virtual terminal controller.

- UT and ECU Address – the address the UT has acquired on the BUS
- Part 6 Version and Status
- Softkey Size – displays softkey size in pixels
- Virtual Number – the total number of possible softkeys.
- Physical Number – number of softkeys able to be shown at one time in the side menu
- Font – define Small, Large, and Attributes
- Colour – indicates the colour scheme used on the system
- HW – hardware
- Datamask Size – indicates the screen size in pixels

Figure 5-11: UT Data Diagnostics

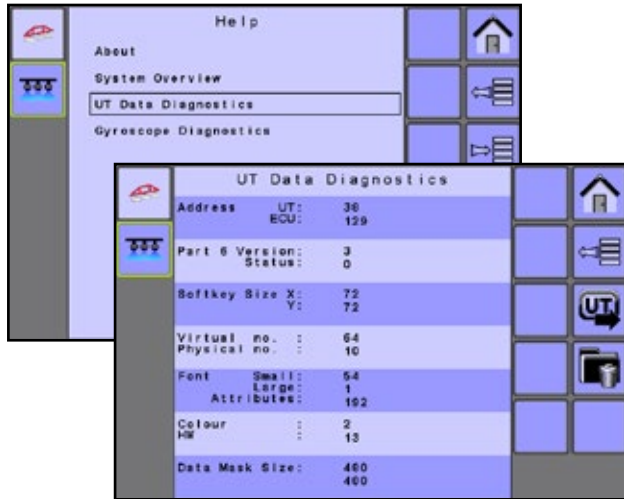

Use these softkeys to change UTs or delete object pools:



Next UT – Press to switch between terminals/controllers when more than one is used



Delete Object Pools – Press to delete saved information on the UT and force the UT to upload all information from the controller on the next power cycle

Gyroscope Diagnostics

Provides information regarding the gyroscope.

- Orientation
 - Horizontal, Label Up
 - Horizontal, Label Down
 - Vertical, Connectors Up
 - Vertical, Connectors Down
 - Vertical, Left Edge Up
 - Vertical, Right Edge Up
- X Angle/Pitch - This is the front to back rotation of the DynaJet IC7140 ECU as compared to the vehicle. How many degrees it must be rotated from the Base Orientation position [X: Front, Y: Right] to match the actual orientation on the vehicle.
- Y Angle/Roll - This is the side to side rotation of the DynaJet IC7140 ECU as compared to the vehicle. How many degrees it must be rotated from the Base Orientation position [X: Front, Y: Right] to match the actual orientation on the vehicle.
- Z Angle/Yaw - This is the rotation of the DynaJet IC7140 ECU compared to the vehicle looking down from the top. How many degrees it must be rotated from the Base Orientation position [X: Front, Y: Right] to match the actual orientation on the vehicle.

Figure 5-12: Gyroscope Diagnostics

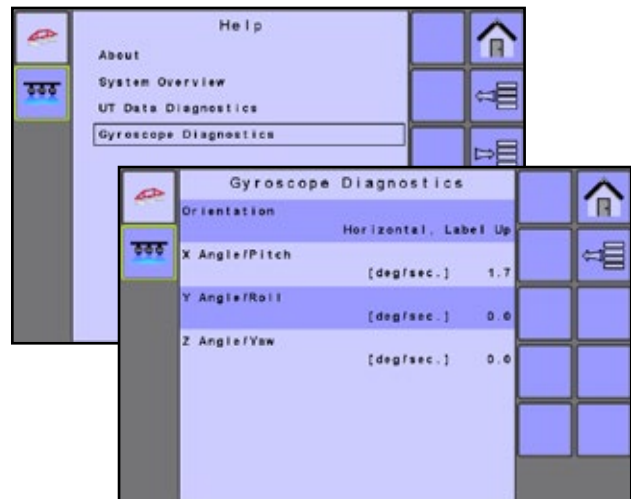

CHAPTER 6 – OPERATION

The operation screen provides the user with important information and controls while operating the system. Information on the Operation screen will vary depending on the parameters set by the user and the OEM. Softkeys on the Operation screen give access to all the functions which are required during operation, and will change with the Operation Mode selected.

Figure 6-1: Operation Screen Overview

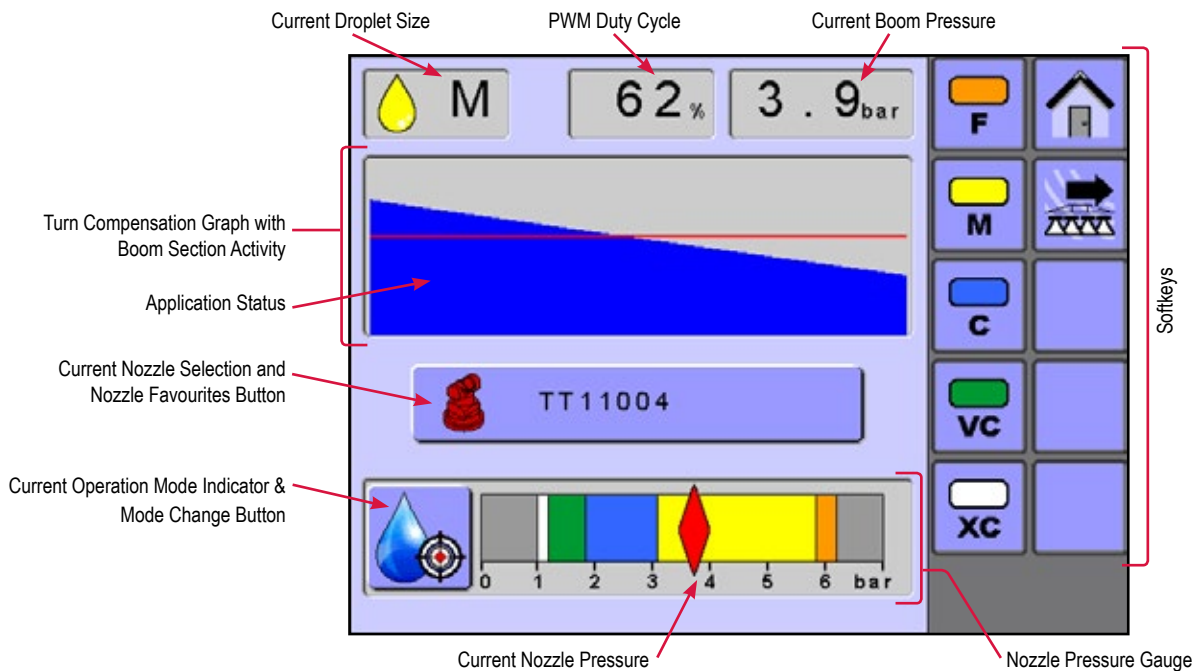

Table 6-6: Operation Screen Options

Softkey	Description
Active Information bar	Displays the current droplet size using both the appropriate colour droplet icon and size letter code, the current PWM duty cycle and the actual pressure of the boom measured by the pressure sensor
Turn Compensation Graph with Boom Section Activity <i>NOTICE: Turn compensation will not available when the system has two BIMs.</i>	Turn Compensation On – As the vehicle turns, the PWM value of each nozzle is displayed on the screen as a graph to show how the system adjusts the PWM to compensate for the turn rate of the vehicle Turn Compensation Off – the turn compensation graph is replaced with a static boom graphic. Boom section activity is indicated below the boom graphic.
TT 11004 Current Nozzle Selection	Displays the active nozzle for determining current droplet size information and can be used to go to the Nozzle Favorites screen to change the current nozzle or preset additional nozzles
Nozzle Pressure Gauge	Displays Current Operation Mode Indicator & Mode Change Button, available droplet sizes using the appropriate droplet size colours (disabled sizes are crossed out, when available), the average actual solenoid pressure (red diamond), and target average solenoid pressure (green diamond, when available)
Home	Press to go to the Home screen
Turn Compensation On/Off	Press to toggle turn compensation on or off
Multiple Pages	Press to toggle between softkey menu lists when more softkeys are available than can be shown on one screen <i>NOTE: Only available when more than one page is needed.</i>

Accessing the Operation Screen

The Operation screen can be accessed from the Home screen or from an error message.

Home Screen

1. Press the OPERATION KEY .

Figure 6-2: Operation Screen – from Home Screen

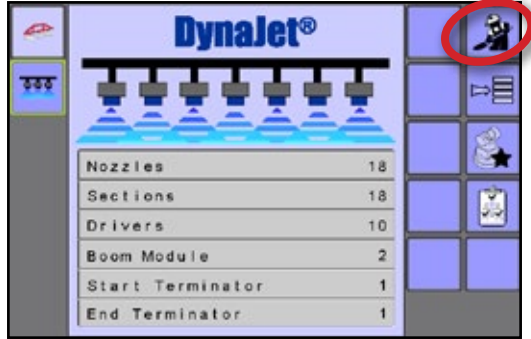

Error Message

1. Select OPERATION KEY .

Figure 6-3: Operation Screen – Through an Error Message



OPERATION MODES

There are three types of Operation Modes:



Manual Mode – Select the intended nozzle and the target PWM Duty Cycle Percentage



Droplet Mode – Select the intended nozzle and the target droplet size range



Pressure Mode – Select the intended nozzle and the target boom pressure

NOTE: Many factors including but not limited to application rate, material density, speed, nozzle model/size/spacing may limit the ability of DynaJet IC7140 to meet the control target.

To select an operation mode:

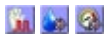
1. Press the CURRENT OPERATION MODE INDICATOR & MODE CHANGE BUTTON  on the Nozzle Pressure Gauge. Modes will toggle from Manual Mode to Droplet Mode to Pressure Mode.

Manual Mode

Select the intended nozzle and the target PWM Duty Cycle Percentage. The system will calculate and display the droplet sizes for the nozzle selected. DynaJet IC7140 will control to the target Duty Cycle Percentage.

Figure 6-4: Operation Screen – Manual Mode

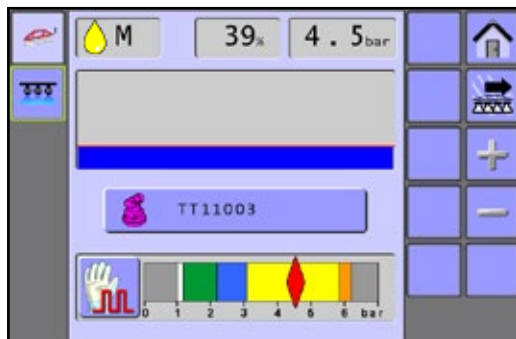

Adjusting PWM Duty Cycle



PWM Increase – Press to increase the PWM Duty Cycle Percentage



PWM Decrease – Press to decrease the PWM Duty Cycle Percentage

Figure 6-5: Pressure Gauge – Pressure Indicator

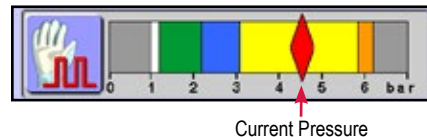

Droplet Mode

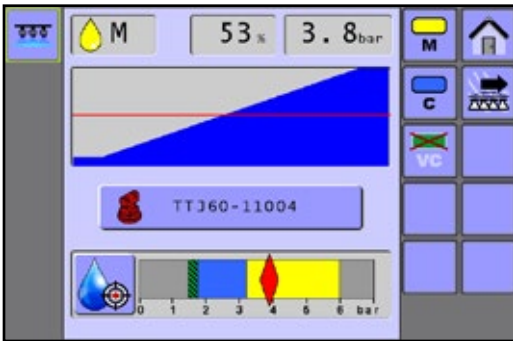

Select the intended nozzle and the target droplet size range. The system will calculate and display the median boom pressure required to meet this droplet size range for the nozzle selected. DynaJet IC7140 will control to maintain the target droplet size range.

Figure 6-6: Operation Screen – Droplet Mode



Droplet Size Engaged/Disabled

Use these softkeys to enable or disable droplet sizes. Droplet selection cannot have skips within the size sequence.

-  Droplet Size Engaged – Indicates the droplet size is included in calculating the target pressure; Press to disable the droplet size
-  Droplet Size Disabled – indicates the droplet size is not included in calculating the target pressure; Press to enable the droplet size

Disabled sizes will be crossed out on the pressure gauge.

Figure 6-7: Pressure Gauge – Droplet Size Disabled

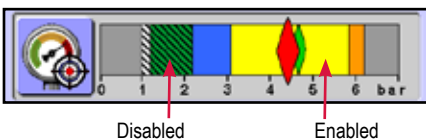

Pressure Mode

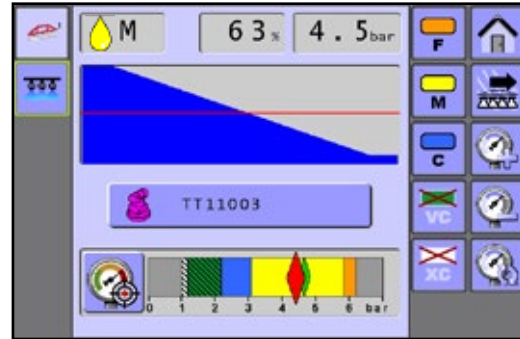

Select the intended nozzle and the target boom pressure. The system will calculate and display the droplet size for the nozzle selected at the target boom pressure. DynaJet IC7140 will control to maintain the target boom pressure.

Figure 6-8: Operation Screen – Pressure Mode



Droplet Size Engaged/Disabled

Use these softkeys to enable or disable droplet sizes. Droplet selection cannot have skips within the size sequence.

-  Droplet Size Engaged – Indicates the droplet size is included in calculating the target pressure; Press to disable the droplet size
-  Droplet Size Disabled – indicates the droplet size is not included in calculating the target pressure; Press to enable the droplet size

Disabled sizes will be crossed out on the pressure gauge.

Figure 6-9: Pressure Gauge – Droplet Size Disabled

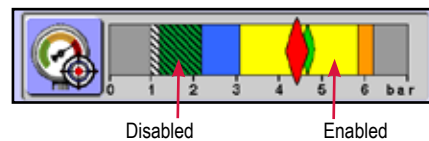

Adjusting Target Pressure



-  Pressure Increase – Press to increase the target pressure
-  Pressure Decrease – Press to decrease the target pressure
-  Pressure Reset – Press to clear the increase/decrease to the target pressure

Figure 6-10: Pressure Gauge – Pressure Indicators



BOOM APPLICATION STATUS

Turn Compensation On

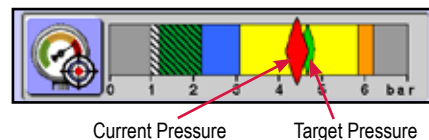
As the vehicle turns, the PWM value of each nozzle is displayed on the screen as a graph to show how the system adjusts the PWM to compensate for the turn rate of the vehicle.

- ◀ Boom Status On – blue
- ◀ Boom Status Off – grey
- ◀ PWM Duty Cycle – red horizontal line

NOTICE: Turn compensation will not available when the system has two BIMs.

Figure 6-11: Turn Compensation On – Right Turn, Pressure Mode

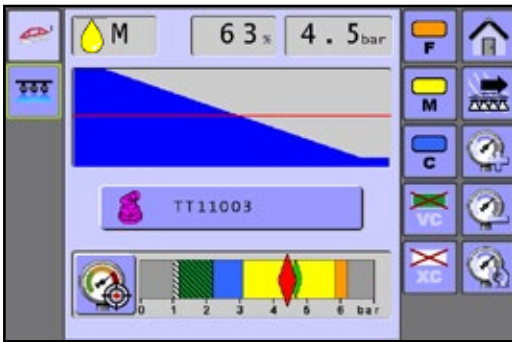

Figure 6-12: Turn Compensation On – Straight, Manual Mode

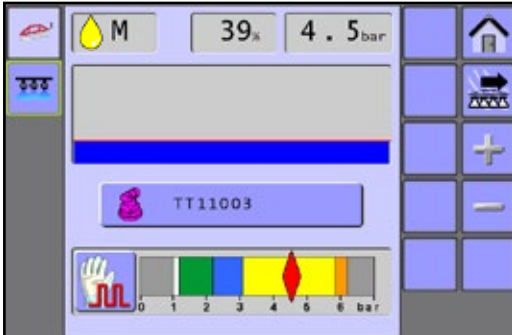
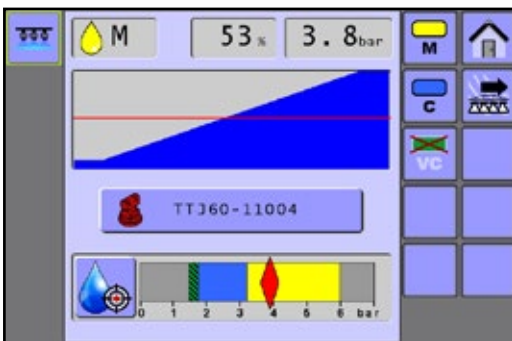

Figure 6-13: Turn Compensation On – Left Turn, Droplet Mode



Good Practices Guide

DynaJet IC7140's capability to compensate rates across the boom while in a turn is influenced by nozzle selection, speed, target rate and rate of turn.

Optimum PWM

When utilizing turn compensation at optimum PWM, it is represented with an even diagonal line on the Turn Compensation graph. Optimum PWM is attained with an acceptable speed and PWM allowing all e-ChemSaver Solenoids to compensate for turn rate without going to Maximum PWM or Minimum PWM.

Figure 6-14: Optimum PWM

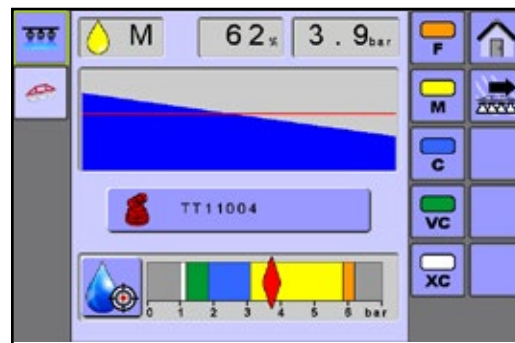

Minimum PWM

As minimum PWM is attained, it is represented with a flat spot on the Turn Compensation graph. Indicating implement speed is too slow, and several e-ChemSaver Solenoids are operating at the minimum PWM, not allowing compensation for the turn rate.

Figure 6-15: Minimum PWM

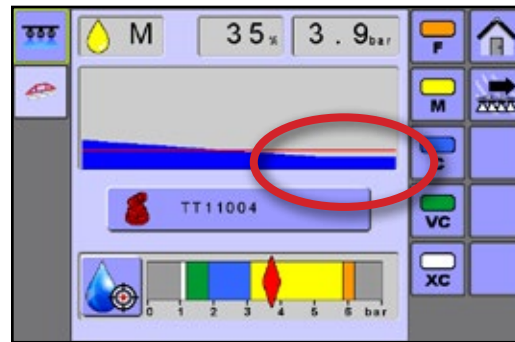

Minimum PWM Solution

If conditions allow, increase speed, or disable a smaller droplet size to force a higher PWM.

Figure 6-16: Minimum PWM Solution

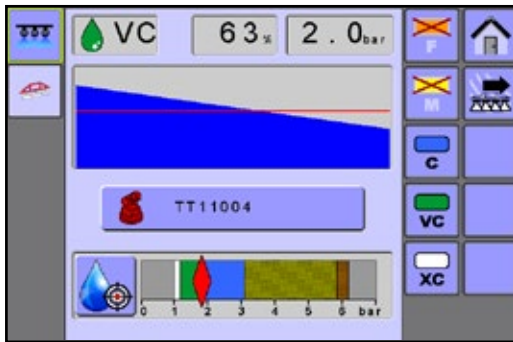

Maximum PWM

As maximum PWM is attained, it is represented with a flat spot on the Turn Compensation graph. Indicating implement speed is too high, and several e-Chemsaver Solenoids are operating at the maximum PWM, not allowing compensation for the turn rate.

Figure 6-17: Maximum PWM

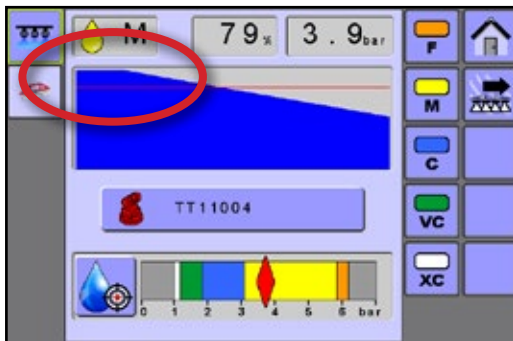

Maximum PWM Solution

If conditions allow, decrease speed, or disable a larger droplet size to force a lower PWM.

Figure 6-18: Maximum PWM Solution

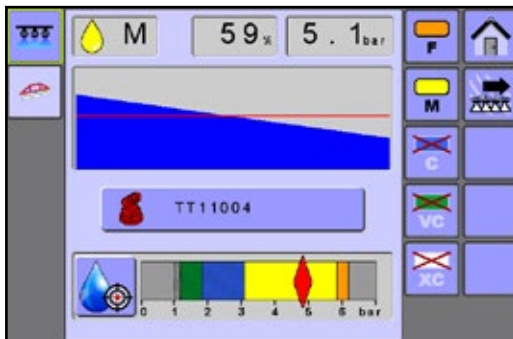

Turn Compensation Off

When turn compensation is off, the turn compensation graph is replaced with a static boom graphic. Boom section activity is indicated below the boom graphic.

- ◀ Boom Status On – Blue
- ◀ Boom Status Off – Gray

Figure 6-19: Turn Compensation Off

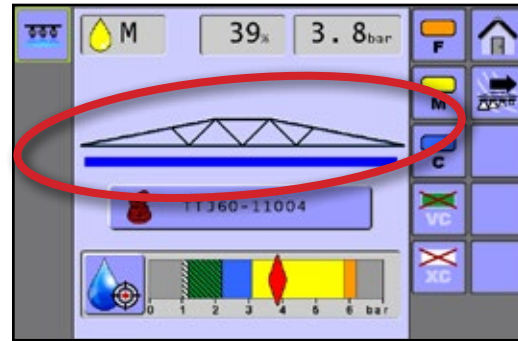

Droplet Size Chart

When choosing a spray nozzle that produces droplet sizes in one of the eight droplet size classification categories, always remember that a single nozzle can produce different droplet size classifications at different pressures. A nozzle might produce medium droplets at low pressures, while producing fine droplets as pressure is increased.

Category	Symbol	Colour code
Extremely fine	XF	Violet
Very fine	VF	Red
Fine	F	Orange
Medium	M	Yellow
Coarse	C	Blue
Very coarse	VC	Green
Extremely coarse	XC	White
Ultra coarse	UC	Black

NOTE: Droplet size classifications are based on BCPC specifications and in accordance with ASABE Standard S572.1 at the date of printing. Classifications are subject to change.

CONTROL ERRORS & ALERTS

If there is an active control error, the value background will be red to indicate the error. The specific error will be specified on the pop-up alert screen.

Control alerts will clear themselves when the control has returned to operational range

Errors with control levels are displayed graphically on the Active Information bar to help the operator stay alert of any problems.

NOTE: System Component errors appear on the System Overview screen. See the System Overview chapter for details.

- Current Droplet Size – Droplet size is not being maintained by the system or Nozzle pressure is above/below the recommended nozzle pressure range
- PWM Duty Cycle – Desired pressure is not being maintained by the system
- Current Boom Pressure – System pressure is above the high pressure alarm value

Figure 6-20: Control Error Example

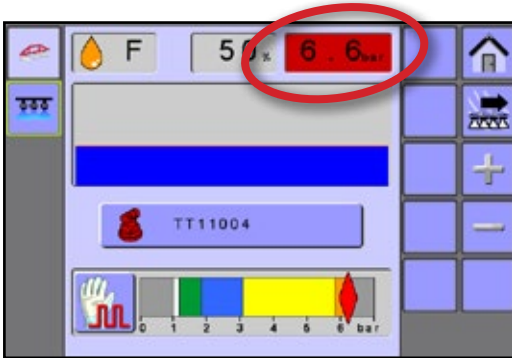

Pop-up Alert Screens

If there is an active error, an alert screen will appear providing specific information and associated error code.

See "Appendix C – Troubleshooting Guide" for details on specific errors.



Figure 6-21: System Alert Example



NON-TOUCHSCREEN UT OPTIONS

When using a UT that does not have a touchscreen, screen options will be available as additional softkeys not illustrated in the examples in this manual. Use these softkeys to navigate through the options:

Operation Modes

-  To Pressure Mode – Press to change operation mode to pressure mode
-  To Droplet Mode – Press to change operation mode to droplet (automatic) mode
-  To Manual Mode – Press to change operation mode to manual (PWM) mode

Nozzle Favourites

-  Nozzle Favourites – Press to go to the Nozzle Favourites screen

CHAPTER 7 – NOZZLE FAVOURITES





 The Nozzle Favourites screen displays the current selected nozzle for determining droplet size information, and provides five (5) preset settings for quick recall.

Figure 7-1: Nozzle Favourites Screen

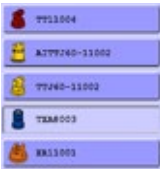

Table 7-7: System Overview Options

Softkey	Description
 Home	Press to go to the Home screen
 Back One Screen	Press to return to the Operation screen or Home screen
 Nozzle Presets	Use to select up to five (5) nozzles for quick recall, and select the current nozzle for determining droplet size information <i>WARNING! With each nozzle change or when nozzles are replaced, a system calibration (steps 4-7 in the "Initial Startup & Calibrations" chapter) must be completed before attempted operation. These configurations may affect Coarse Gain and Fine Gain settings. Failure to properly configure and calibrate the system will result in sub-standard performance.</i>
 Add Nozzle Button	Press to go to the Nozzle Selection screen to specify which nozzle should be assigned to the associated Nozzle Preset button

Accessing the Nozzle Favourites Screen

The Nozzle Favourites screen can be accessed from the Home screen or the Operation screen.

Home Screen

1. Press the NOZZLE FAVOURITES KEY .

Figure 7-2: Nozzle Favourites – from Home Screen

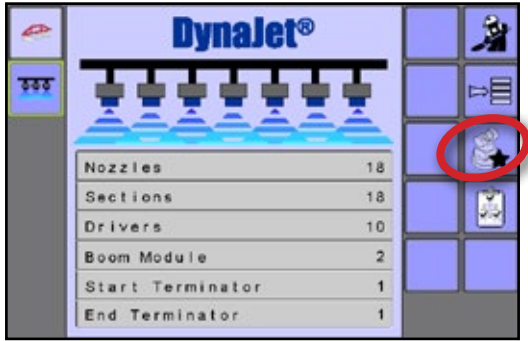

Operation Screen

1. Press the CURRENT NOZZLE BUTTON  TT11004.

Figure 7-3: Nozzle Favourites – from Operation Screen

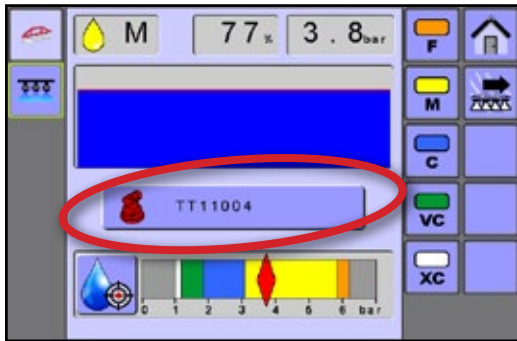

NOZZLE PRESETS

Nozzle presets allow saving of up to five nozzles for quick recall. The selected current nozzle is used to determine droplet size information.

To set or change a nozzle favourite:

1. Next to the location of the Nozzle Preset button to be changed, press the ADD NOZZLE BUTTON .
2. Select a nozzle series.
3. Select a nozzle capacity from the series selected.

Figure 7-4: Add Nozzle

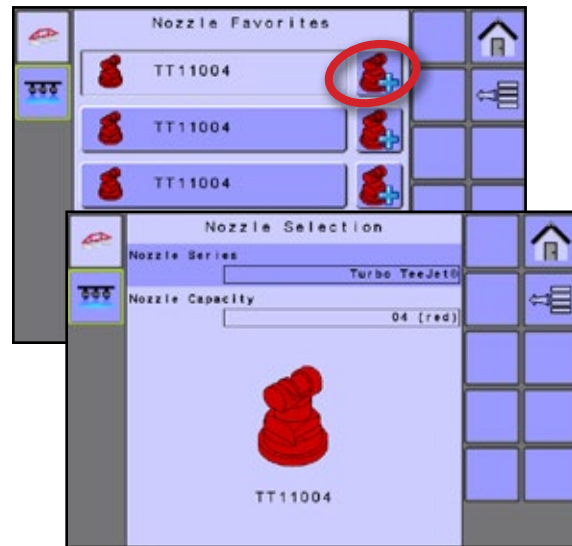

Figure 7-5: Nozzle Sizes and Associated Colours

Established nozzle capacities and colours			
Size	Colour	Size	Colour
0050	Blue lilac	05	Nut brown
0067	Olive green	06	Signal grey
01	Pure orange	08	Traffic white
015	Traffic green	10	Light blue
02	Zinc yellow	12	Raspberry red
025	Signal violet	15	Yellow green
03	Gentian blue	20	Graphite black
035	Purple red	30	Beige
04	Flame red		

CURRENT NOZZLE SELECTION

The active nozzle for determining current droplet size information is the selected button. Nozzles must be preset to be available for current nozzle selection. If no nozzle has been specified for that button location, the system will return to Nozzle Selection screen.

WARNING! With each nozzle change or when nozzles are replaced, a system calibration (steps 4-7 in the “Initial Startup & Calibrations” chapter) must be completed before attempted operation. These configurations may affect Coarse Gain and Fine Gain settings. Failure to properly configure and calibrate the system will result in sub-standard performance.

To select an active nozzle:

1. Press desired nozzle.

Figure 7-6: Select Current Nozzle



Figure 7-7: Current Nozzle on Operation Screen

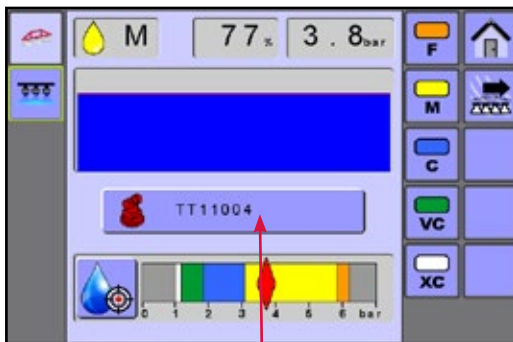

Current Nozzle

CHAPTER 8 – SYSTEM OVERVIEW

Displays system graphically to help the operator locate any problems as well as give information on selected drivers or solenoids.

NOTE: Information on the System Overview screen will vary depending on the parameters set by the user and the OEM.

Figure 8-1: System Overview Screen Without Errors

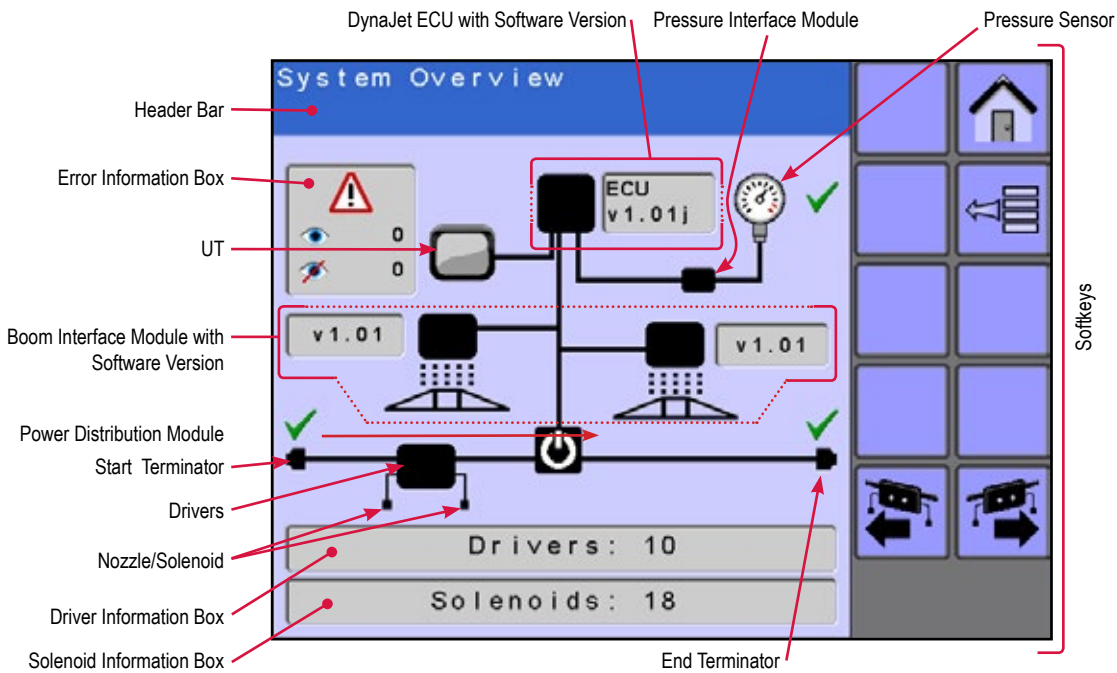

Table 8-8: System Overview Options

Softkey	Description
Home	Press to go to the Home screen
Back One Screen	Press to return to the Help menu screen or Home screen
Previous/Next Driver	Press to access the driver information on the previous or next screen
Reset Error Log	Press to clear all error log counts to zero, including ignored errors, then checks for new errors <i>NOTE: When there are no errors, softkey is not available.</i>
Error Information	Press to access details about errors <i>NOTE: When there are no errors, softkey is not available.</i>

Accessing the System Overview Screen

The System Overview screen can be accessed from multiple locations including directly from the Home screen, through the Main Setup-> Help options or from an error message.

Main Menu

1. Select MAIN SETUP SCREEN KEY  from the Home screen.
2. Select **Help**.
3. Select **System Overview**.

Figure 8-2: System Overview – Through Main Setup



Home Screen

1. Select SYSTEM OVERVIEW KEY .

Figure 8-3: System Overview – Through the Home Screen



Error Message

1. Select SYSTEM OVERVIEW KEY .

Figure 8-4: System Overview – Through an Error Message



DRIVER/SOLENOID INFORMATION



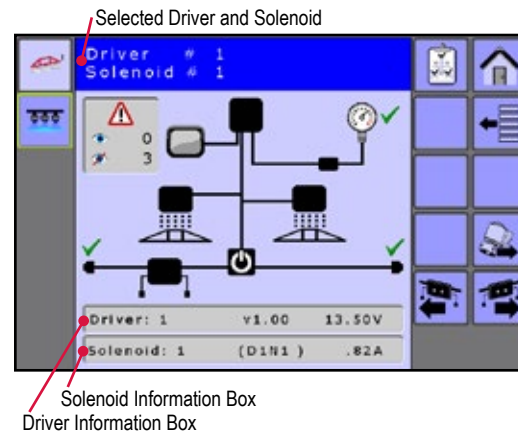

Specific information about each driver and its associated solenoids can be accessed using the Previous Driver, Next Driver and Next Solenoid softkeys.

Drivers and solenoids are numbered from left to right while facing in the machine's forward direction.

Figure 8-5: Drivers and Solenoids



Use these softkeys to navigate through the information screens:

-  Next Driver – Press to go the driver on the next screen
-  Previous Driver – Press to go the driver on the previous screen
-  Next Solenoid – Press to view the next solenoid on the selected driver
-  Return to System Overview – Press to go to the system overview screen

Driver Information

The information box displays the driver number, its software version and voltage at the driver.

Figure 8-6: Driver Information

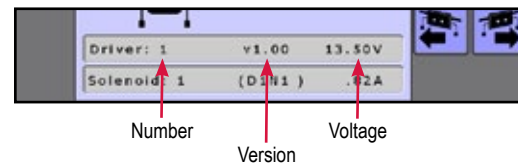

To access the other drivers:

1. Press PREVIOUS DRIVER / NEXT DRIVER KEYS  .

Figure 8-7: Previous / Next Driver

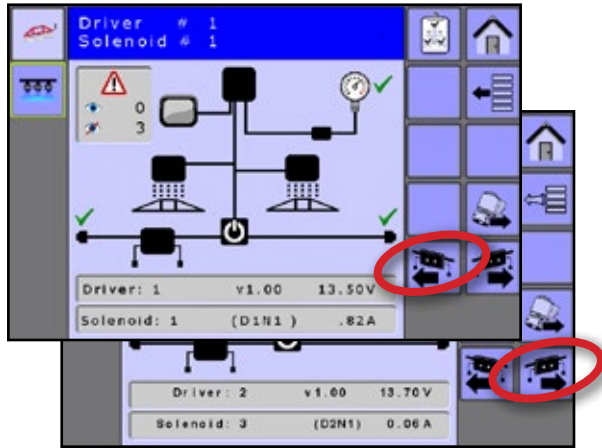

Solenoid Information

The information box displays the selected solenoid number, location and current through the coil. Solenoid location is notated with the driver number (D) and output number (N).

Figure 8-8: Solenoid Information



To access another solenoid on the selected driver:

1. Press NEXT SOLENOID KEY

Figure 8-9: Next Solenoid

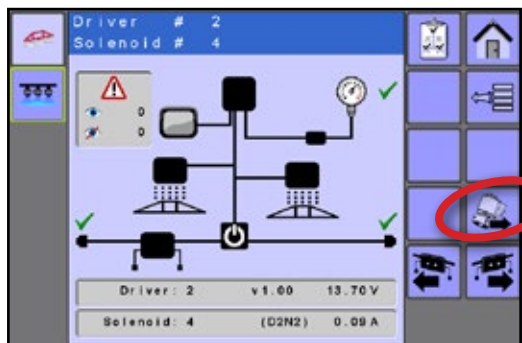

SYSTEM ERRORS

Errors with components of the system are displayed graphically on the System Overview screens to help the operator locate any problems.

NOTE: Operation errors appear on the Operation screen. See the Operation chapter for details.

Pop-up Alert Screens

If there is an active error, an alert screen will appear providing specific information, associated error code and a softkey to go directly to the System Overview screen.

See "Appendix C – Troubleshooting Guide" for details on specific errors.

Figure 8-10: System Alert Example



Use these softkeys to navigate from the pop-up screen:

- System Overview – Press to go to the System Overview screens for troubleshooting issues
- Accept – Press to acknowledge a system alert and return to the previous screen

NOTE: Ignored and/or accepted driver and solenoid errors will be acknowledged on their associated information screens.

System Overview Screen







The system overview screen will indicate the offending system component in red with an error icon. The specific error will be specified on the screen header. The Error Information Box displays the number of current errors  and number of ignored errors .

Figure 8-11: System Overview Error Example

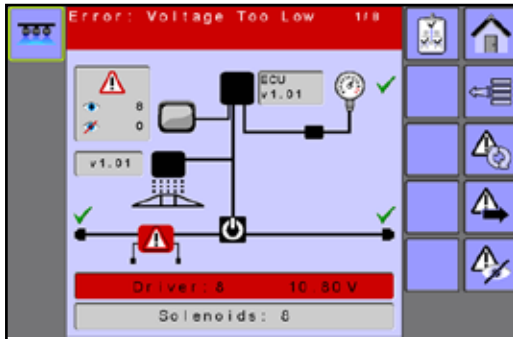

Use these softkeys to navigate through the errors:

-  Refresh Error Log – Press to clear the error log counts to zero, including ignored errors, then checks for new errors
-  Next Error – Press to view the next error when multiple errors occur
-  Next Error Greyed – only one error available
-  Ignore Error – Press to disregard an error (not all errors can be ignored)

NOTE: All ignored errors will be reset/cleared when the system is repowered.

Home Screen Visibility

The Home screen gives the user a quick overview of the status of the system. Initialisation errors and system errors appear to alert the operator of certain issues and can prevent the console from entering operation mode until rectified.

Figure 8-12: Initialisation Error Example

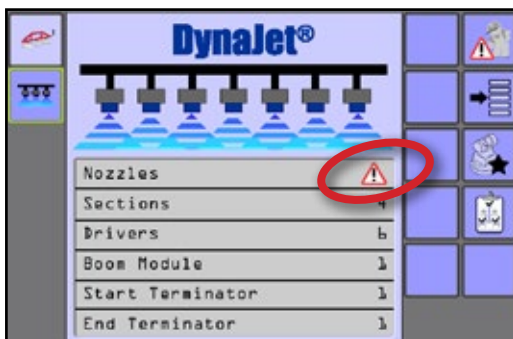

DYNAJET IC7140

SETUP OPTIONS FOR SOFTWARE v1.01

Main Setup -> Machine Setup

Description	Factory Default	Range/Options	Suggested Setting	Use Default
Number of Sections with one (1) BIM	0	1 - 15		
Number of Sections with two (2) BIMs	5	1 - 30		
Nozzles per Section	3	1 - 240		
Nozzle Spacing	50 cm / 20 in	1 - 2,000 cm / 1 - 787 in		
Pressure Sensor Maximum	10 bar / 145 psi	5.00 - 30.00 bar / 73 - 435 psi		
Minimum Duty Cycle	30%	20% - 40%		
Control Hold Delay	1.0 seconds	0.0 - 10.0 seconds		
Coarse Gain	4	1 - 20		
Fine Gain	6	1 - 20		

Main Setup -> OEM Settings

Description	Factory Default	Range/Options	Suggested Setting	Use Default
PWM Frequency	20 Hz	5 - 25 Hz		
On Impulse Duration	38 counts	0 - 128		
Hold Current Frequency Adjustment	10 counts	5 - 20		
Hold Current Duty Cycle	5 counts	1 - 20		
Phase Offset	128 counts	0 - 255		
Jump Point	0.35 bar / 5 psi	0.00 - 2.11 bar / 0 - 31 psi		
Maximum Duty Cycle	92%	70% - 100%		
PWM Off Time	20	0 - 100		
Low Voltage Limit	11.0V	0.0 - 20.0V		
High Voltage Limit	15.0V	0.0 - 20.0V		
Low Amps Limit	0.4A	0.0 - 20.0A		
High Amps Limit	1.2A	0.0 - 20.0A		
High Pressure Alarm	6.0 bar / 87 psi	4.0 - 25.0 bar		
Droplet Size Damping	0.10	0.01 - 0.99		
ECU Orientation	Horizontal, Label Up	<ul style="list-style-type: none"> • Horizontal, Label Up • Horizontal, Label Down • Vertical, Connectors Up • Vertical, Connectors Down • Vertical, Left Edge Up • Vertical, Right Edge Up 		

Main Setup -> User Interface

Description	Factory Default	Range/Options	Suggested Setting	Use Default
Use Preferred UT	Off	<ul style="list-style-type: none"> • Off • On 		
Boom Section Beep	Off	<ul style="list-style-type: none"> • Off • On 		
Turn Compensation Visual	On	<ul style="list-style-type: none"> • Off • On 		

Nozzle Favourites

Order	Specific Nozzle	Nozzle Series	Nozzle Capacity
#1			
#2			
#3			
#4			
#5			

NOTES



APPENDIX A – 115880 E-CHEMSAVER® MAINTENANCE INSTRUCTIONS

The 115880 e-ChemSaver is a solenoid-actuated shutoff compatible with a wide range of TeeJet nozzle bodies equipped with a diaphragm check valve. It can be used for end-of-boom nozzles as well as individual nozzle shutoff and PWM controls.

The valve is normally closed and opens when the solenoid is energised. The 115880 has a 2-Pin Superseal 1.5 connector moulded into the body for a clean, weather-tight electrical connection.

APPLICATION NOTE: Rinse system with clean water after each application.

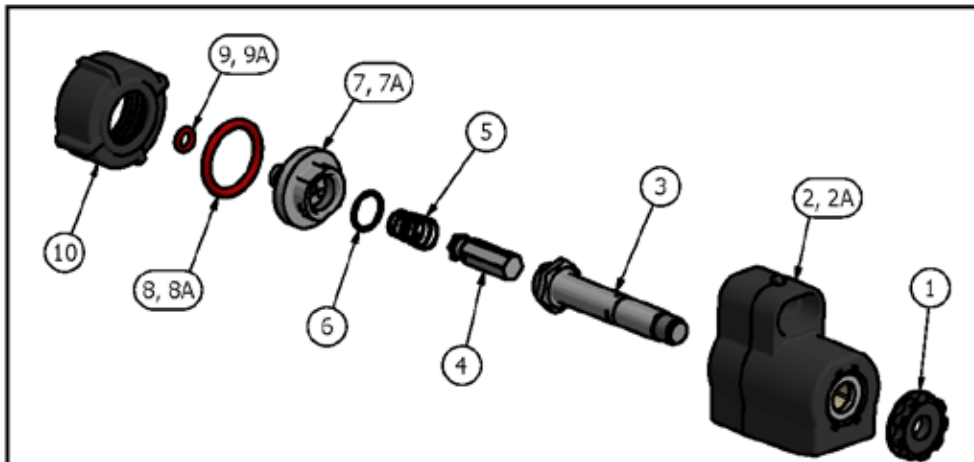

ITEM	PART NUMBER	DESCRIPTION
1	CP55289-NYB	NUT, NYLON-BLACK
2	CP115881-12	12V COIL ASSEMBLY
2A	CP115881-24	24V COIL ASSEMBLY
3	N/A	TUBE SUB-ASSEMBLY
4	N/A	PLUNGER SUB-ASSEMBLY
5	N/A	SPRING, 302 STAINLESS STEEL
6	N/A	O-RING, VITON®
7	N/A	INTERFACE CAP, 303 STAINLESS (115880-1-12 & 115880-4-12)
7A	N/A	INTERFACE CAP, 303 STAINLESS (115880-2-12)
8	CP7717-2/116-VI	O-RING, VITON® (115880-1-12 & 115880-2-12)
8A	CP58589-VI	GASKET, VITON® (115880-4-12)
9	CP7717-2-007/VI	O-RING, VITON® (115880-1-12 & 115880-4-12)
9A	CP7717-M4.2X1.9-VI	O-RING, VITON® (115880-2-12)
10	CP55288-NYB	LOCKING RING, NYLON-BLACK

SPARE KITS	
AB115880-1-KIT, SPARE PARTS KIT (INCLUDES 4, 5, 6, 8, 9)	
AB115880-2-KIT, SPARE PARTS KIT (INCLUDES 4, 5, 6, 8, 9A)	
AB115880-4-KIT, SPARE PARTS KIT (INCLUDES 4, 5, 6, 8A, 9)	

VITON® IS A REGISTERED TRADEMARK OF THE CHEMOURS COMPANY.

DESCRIPTION:
 115880-1-12, 115880-2-12, 115880-4-12,
 115880-1-24, 115880-2-24, 115880-4-24
 e-CHEMSAVER SOLENOID OPERATED
 ELECTRIC SHUT-OFF VALVE



REVISION NO.	1	Parts List No.	PL115880
REFERENCE:	06/29/18	SHEET:	1 OF 1
		DWG SIZE:	A

©Spraying Systems Co.

General Disassembly and Reassembly

NOTE: O-rings (6, 8, 9) should be handled with care as they can be damaged/deformed

1. Loosen and remove the nylon Nut (1).
2. Separate the Coil Assembly (2) from the rest of the Tube/Plunger Assembly (3-10).
3. Remove the Locking Ring (10).
4. Using pliers to grip the stainless steel Interface Cap (7), loosen the Tube Sub-Assembly (3) using a 14 mm / 9/16" or adjustable wrench.
 - ▶ All repairable parts should be accessible at this point. The Plunger Sub-Assembly (4), stainless steel Spring (5), and O-rings (6, 8, 9) can be replaced without further disassembly.
5. During reassembly, place the Plunger Sub-Assembly (4) and stainless steel Spring (5) in the Tube Sub-Assembly (3).

NOTE: The Plunger Sub-Assembly (4) should be orientated with the black insert facing outward (visible) when placed in the Tube Sub-Assembly (3).
6. While compressing the Spring (5), thread the Tube/Plunger Assembly (3-10) to the stainless steel Interface Cap (7) and tighten using a wrench and pliers.
 - ▶ Optional: Apply 1 drop of Loctite Blue 243 to the threads of the Interface Cap (7) and Tube Sub-Assembly (3).
 - ▶ Torque Specifications: Tighten Interface Cap (7) and Tube Sub-Assembly (3) to 1.36 N-m / 12 in-lbs.
7. Return the Locking Ring (10) to its original position and slide the Tube/Plunger Assembly (3-10) through the Coil Assembly (2).

NOTE: The Coil Assembly (2) should be orientated with the SuperSeal 1.5 connector facing away from the Interface Cap (7).
8. Tighten the nylon Nut (1) to the Tube/Plunger Assembly (3-10).

DYNAJET IC7140 NOZZLE SELECTION

Selection of the proper spray nozzle for use with the DynaJet IC7140 system is much like selecting the spray nozzle for a traditional spraying operation. Along with the extra application flexibility, DynaJet IC7140 brings a few other nozzle-related considerations that will be summarised below.

1. Duty Cycle

- a. DynaJet IC7140 controls nozzle flow rate by varying the portion of time that each nozzle is 'on' vs. 'off'. The on time is referred to as duty cycle. The range of duty cycle available is typically 30% to 100%, meaning that the nozzles on the machine will have the approximately 30% to 100% of their rated flow capacity.
- b. With the DynaJet IC7140 system: **spray nozzle flow capacity = spray nozzle size x duty cycle**
- c. By varying the duty cycle, the DynaJet IC7140 is essentially varying spray nozzle capacity on the fly. When more pressure is required, the nozzle capacity (duty cycle) is reduced. When higher nozzle capacity is required, the duty cycle is increased.
- d. Although the operator has a much more flexible and forgiving application system with DynaJet IC7140, care should be taken to select spray nozzles that give the best possible results.
- e. When selecting a spray nozzle, review the DynaJet IC7140 nozzle selection charts and select a spray nozzle capacity that produces the target application rate at a duty cycle of about 70% when running at expected travel speeds. In other words, choose nozzle capacity and desired pressure/droplet size closer to the high end of the speed (or rate) range than to the lower end. This will provide plenty of adjustment range for DynaJet IC7140 to reduce duty cycle when travel speed slows, while also providing additional capacity if travel speed increases above the planned speed.
 - The default setting for minimum duty cycle is 30%. This means the system will not adjust the duty cycle below 30% 'on'. While this setting can be set as low as 20% by the operator, the higher default value provides a more uniform application at lower speeds.

2. Spray Nozzle Selection

- a. The DynaJet IC7140 system is not compatible with all spray nozzles. Approved nozzle series include: AI Turbo TwinJet, Turbo TeeJet Induction TwinJet, Turbo TeeJet, Turbo TeeJet Induction, Turbo TwinJet, TwinJet 110, TX ConeJet, TXA ConeJet, TXR ConeJet, XR TeeJet 110 and XRC TeeJet 110.

NOTE: Listed series may not include all available capacities. Changes to series and/or capacities may occur with software updates.

- b. Different nozzle styles have different droplet size characteristics across the range of operating pressures. The spray nozzle style should be selected based on the desired droplet size at the pressures expected to be in use for your application.
- c. Always use spray nozzles with 110° (or wider) spray pattern. These spray nozzle part numbers will typically include the 110 in their name – for example TT11006VP or XR11006-VS. 80° spray nozzles are not recommended with DynaJet IC7140.

3. Spray Height

- a. In order to achieve the best possible spray coverage, make sure to keep spray height at or above 50 centimetres / 20 inches from the nozzle to the target.

Nozzle/Tip Selection Chart Explanation

	These columns show flow rates at various pressures. The Delta P represents pressure loss through the DynaJet IC7140 solenoid valve, and the resulting nozzle PSI/bar and flow show actual values at the spray nozzle.	These columns show droplet sizes for different styles of spray nozzle at given pressures. Use these columns to choose the best nozzle style for your application.	Just like a normal nozzle chart, these columns show rates available at given speeds. The only difference is the range of values that corresponds to the range of flows available with DynaJet IC7140.
--	---	---	---

Nozzle/Tip Size Selection Example

METRIC: If the operator wants to apply 250 l/ha at 10 km/h, he would look in the 10 km/h column, and find the row that shows 250 l/ha with room above and below to compensate for higher and lower speeds that may be experienced in the field. In this case a TT11006 at 3-4 bar will work very well.

Nozzle No. (Mesh Size)	Gauge Pressure (Bar)	Rated L/Min	Δ P	Nozzle		Minimum Duty Cycle: 30%							Nozzle Spacing 50 cm					
				Pressure (Bar)	Flow (L/Min)	TJ60	XR/XRC	TT	TTJ60	A/TTJ60	TT160	TTI	5 km/h l/ha	6 km/h l/ha	8 km/h l/ha	10 km/h l/ha	12 km/h l/ha	14 km/h l/ha
11006	1.5	1.66	0.2	1.3	1.56	-	M	VC	-	-	-	UC	112 to 374	84 to 312	70 to 234	56 to 167	47 to 156	40 to 134
XR XRC TT	2	1.94	0.3	1.7	1.81	-	M	VC	VC	UC	UC	UC	120 to 434	109 to 362	81 to 272	65 to 217	54 to 181	47 to 156
TJ60 TTJ60	3	2.30	0.4	2.5	2.23	M	M	C	C	XC	UC	UC	161 to 536	134 to 446	100 to 336	90 to 269	67 to 223	57 to 191
A/TTJ60	4	2.74	0.5	3.5	2.57	F	M	M	C	VC	UC	UC	185 to 617	154 to 514	116 to 386	93 to 308	77 to 257	66 to 220
TT160 TTI	5	3.07	0.5	4.4	2.88	-	-	M	M	C	XC	XC	207 to 691	173 to 576	130 to 432	104 to 346	95 to 298	74 to 247
(50)	6	3.36	0.7	5.3	3.15	-	-	F	M	C	XC	XC	227 to 756	189 to 630	142 to 473	113 to 376	95 to 315	81 to 270
	7	3.63	0.8	6.2	3.41	-	-	-	-	-	XC	XC	246 to 818	205 to 682	153 to 512	123 to 409	102 to 341	88 to 292

US: If the operator wants to apply 15 GPA at 10 MPH, he would look in the 10 MPH column, and find the row that shows 15 GPA with room above and below to compensate for higher and lower speeds that may be experienced in the field. In this case a TT11006 at 40-50 PSI will work very well.

Tip No. (Mesh Size)	Gauge Pressure (PSI)	Rated GPM	Δ P	Tip		Minimum Duty Cycle: 30%							Tip Spacing 20 Inches					
				PSI	Flow	TJ60	XR/XRC	TT	TTJ60	A/TTJ60	TT160	TTI	4 MPH GPA	6 MPH GPA	8 MPH GPA	10 MPH GPA	12 MPH GPA	14 MPH GPA
11006	20	0.42	3	17	0.39	-	C	XC	-	-	-	UC	8.7 to 29	5.8 to 19.3	4.3 to 14.5	3.5 to 11.6	2.9 to 9.7	2.5 to 8.3
XR XRC TT	30	0.52	4	26	0.48	-	M	VC	VC	XC	UC	UC	10.7 to 35	7.1 to 24	5.3 to 17.6	4.3 to 14.3	3.6 to 11.9	3.1 to 10.2
TJ60 TTJ60	40	0.60	5	36	0.56	M	M	C	C	XC	UC	UC	12.5 to 42	8.3 to 28	6.2 to 21	5.0 to 16.6	4.2 to 13.9	3.6 to 11.9
A/TTJ60	50	0.67	5	44	0.63	M	M	M	C	VC	UC	UC	14.0 to 47	9.4 to 31	7.0 to 23	5.6 to 18.7	4.7 to 15.6	4.0 to 13.1
TT160 TTI	60	0.73	7	53	0.69	F	M	M	C	VC	UC	UC	15.4 to 51	10.2 to 34	7.7 to 26	6.1 to 20	5.1 to 17.1	4.4 to 14.5
(50)	70	0.79	8	62	0.74	-	-	M	M	VC	XC	XC	16.5 to 55	11.0 to 37	8.2 to 27	6.6 to 22	5.5 to 18.3	4.7 to 15.7
	80	0.85	9	71	0.80	-	-	M	M	C	XC	XC	17.8 to 59	11.9 to 40	8.9 to 30	7.1 to 24	5.9 to 19.6	5.1 to 17.0

Nozzle/Tip Series Selection Example

METRIC: The next consideration is droplet size. The chart shows that a Turbo TeeJet (TT) nozzle will give Coarse (C) to medium (M) droplets in this pressure range, and a Turbo TwinJet (TTJ60) will give Coarse (C) droplets. The benefit of the TT is that the operator could select droplets from C to M all at the same rate and speed.

Nozzle No. (Mesh Size)	Gauge Pressure (Bar)	Rated L/Min	Δ P	Nozzle		Minimum Duty Cycle: 30%							Nozzle Spacing 50 cm					
				Pressure (Bar)	Flow (L/Min)	TJ60	XR/XRC	TT	TTJ60	A/TTJ60	TT160	TTI	5 km/h l/ha	6 km/h l/ha	8 km/h l/ha	10 km/h l/ha	12 km/h l/ha	14 km/h l/ha
11006	1.5	1.66	0.2	1.3	1.56	-	M	VC	-	-	-	UC	112 to 374	84 to 312	70 to 234	56 to 167	47 to 156	40 to 134
XR XRC TT	2	1.94	0.3	1.7	1.81	-	M	VC	VC	UC	UC	UC	120 to 434	109 to 362	81 to 272	65 to 217	54 to 181	47 to 156
TJ60 TTJ60	3	2.30	0.4	2.5	2.23	M	M	C	C	XC	UC	UC	161 to 536	134 to 446	100 to 336	90 to 269	67 to 223	57 to 191
A/TTJ60	4	2.74	0.5	3.5	2.57	F	M	M	C	VC	UC	UC	185 to 617	154 to 514	116 to 386	93 to 308	77 to 257	66 to 220
TT160 TTI	5	3.07	0.5	4.4	2.88	-	-	M	M	C	XC	XC	207 to 691	173 to 576	130 to 432	104 to 346	95 to 298	74 to 247
(50)	6	3.36	0.7	5.3	3.15	-	-	F	M	C	XC	XC	227 to 756	189 to 630	142 to 473	113 to 376	95 to 315	81 to 270
	7	3.63	0.8	6.2	3.41	-	-	-	-	-	XC	XC	246 to 818	205 to 682	153 to 512	123 to 409	102 to 341	88 to 292

US: The next consideration is droplet size. The chart shows that a Turbo TeeJet (TT) nozzle will give Coarse (C) to medium (M) droplets in this pressure range, and a Turbo TwinJet (TTJ60) will give Coarse (C) droplets. The benefit of the TT is that the operator could select droplets from C to M all at the same rate and speed.

Tip No. (Mesh Size)	Gauge Pressure (PSI)	Rated GPM	Δ P	Tip		Minimum Duty Cycle: 30%							Tip Spacing 20 Inches					
				PSI	Flow	TJ60	XR/XRC	TT	TTJ60	A/TTJ60	TT160	TTI	4 MPH GPA	6 MPH GPA	8 MPH GPA	10 MPH GPA	12 MPH GPA	14 MPH GPA
11006	20	0.42	3	17	0.39	-	C	XC	-	-	-	UC	8.7 to 29	5.8 to 19.3	4.3 to 14.5	3.5 to 11.6	2.9 to 9.7	2.5 to 8.3
XR XRC TT	30	0.52	4	26	0.48	-	M	VC	VC	XC	UC	UC	10.7 to 35	7.1 to 24	5.3 to 17.6	4.3 to 14.3	3.6 to 11.9	3.1 to 10.2
TJ60 TTJ60	40	0.60	5	36	0.56	M	M	C	C	XC	UC	UC	12.5 to 42	8.3 to 28	6.2 to 21	5.0 to 16.6	4.2 to 13.9	3.6 to 11.9
A/TTJ60	50	0.67	5	44	0.63	M	M	M	C	VC	UC	UC	14.0 to 47	9.4 to 31	7.0 to 23	5.6 to 18.7	4.7 to 15.6	4.0 to 13.1
TT160 TTI	60	0.73	7	53	0.69	F	M	M	C	VC	UC	UC	15.4 to 51	10.2 to 34	7.7 to 26	6.1 to 20	5.1 to 17.1	4.4 to 14.5
(50)	70	0.79	8	62	0.74	-	-	M	M	VC	XC	XC	16.5 to 55	11.0 to 37	8.2 to 27	6.6 to 22	5.5 to 18.3	4.7 to 15.7
	80	0.85	9	71	0.80	-	-	M	M	C	XC	XC	17.8 to 59	11.9 to 40	8.9 to 30	7.1 to 24	5.9 to 19.6	5.1 to 17.0
	90	0.90	11	79	0.85	-	-	F	M	C	XC	XC	18.9 to 63	12.6 to 42	9.5 to 32	7.6 to 25	6.3 to 21	5.4 to 18.0

Table 10-10: Application Rates - Metric Page 2

Nozzle No. (Mesh Size)	Gauge Pressure (Bar)	Rated L/Min	Δ P	Nozzle		Minimum Duty Cycle: 30%							Nozzle Spacing 50 cm										
				Pressure (Bar)	Flow (L/Min)	T ₃₆₀	XR/XRC	TT	TTJ60	A1TTJ60	TT160	TTI	5 km/h l/ha	6 km/h l/ha	8 km/h l/ha	10 km/h l/ha	12 km/h l/ha	14 km/h l/ha	16 km/h l/ha	18 km/h l/ha	20 km/h l/ha		
11006	1.5	1.68	0.2	1.3	1.56	-	M	VC	-	-	-	-	-	-	112 to 374	94 to 312	70 to 234	56 to 187	47 to 156	40 to 134	35 to 117	31 to 104	28 to 94
XR_XRC TT	2	1.94	0.3	1.7	1.81	-	M	VC	-	-	-	-	-	-	130 to 434	109 to 362	81 to 272	65 to 217	54 to 181	47 to 156	41 to 136	36 to 121	33 to 109
TJ60 TTJ60	3	2.28	0.4	2.5	2.23	M	M	C	C	C	VC	UC	UC	UC	161 to 535	134 to 446	100 to 335	80 to 268	67 to 223	57 to 191	50 to 167	45 to 149	40 to 134
A1TTJ60	4	2.74	0.5	3.5	2.57	F	M	M	C	C	VC	UC	UC	185 to 617	154 to 446	116 to 366	93 to 308	77 to 257	66 to 220	58 to 193	51 to 171	46 to 154	
TT160 TTI	5	3.07	0.6	4.4	2.88	-	M	M	M	M	C	C	XC	XC	207 to 691	173 to 575	130 to 432	104 to 345	86 to 288	74 to 247	65 to 216	58 to 192	52 to 173
(60)	6	3.36	0.7	5.3	3.15	-	-	F	M	M	C	C	XC	XC	227 to 756	189 to 630	142 to 473	113 to 378	95 to 315	81 to 270	71 to 236	63 to 210	57 to 189
	7	3.63	0.8	6.2	3.41	-	-	-	-	-	-	-	XC	XC	246 to 818	205 to 682	153 to 512	123 to 409	102 to 341	88 to 292	77 to 256	68 to 227	61 to 205
11008	1.5	2.23	0.3	1.2	1.96	-	C	XC	-	-	-	-	-	141 to 470	118 to 392	88 to 294	71 to 235	59 to 196	50 to 168	44 to 147	39 to 131	35 to 118	
XR_XRC TT	2	2.68	0.4	1.6	2.28	-	C	VC	VC	VC	UC	UC	UC	164 to 547	137 to 456	103 to 342	82 to 274	68 to 238	59 to 195	51 to 171	46 to 156	41 to 137	
TJ60 TTJ60	3	3.16	0.6	2.4	2.81	M	M	M	M	VC	UC	UC	UC	202 to 674	169 to 562	128 to 422	101 to 337	84 to 281	72 to 241	63 to 211	56 to 187	51 to 169	
A1TTJ60	4	3.65	0.8	3.2	3.25	M	M	M	C	C	VC	UC	UC	234 to 780	195 to 650	146 to 488	117 to 390	98 to 325	84 to 279	73 to 244	65 to 217	59 to 195	
TT160 TTI	5	4.08	1.0	4.0	3.64	M	M	M	C	C	VC	UC	UC	262 to 874	218 to 728	164 to 546	131 to 437	109 to 364	94 to 312	82 to 273	73 to 243	66 to 219	
(60)	6	4.47	1.2	4.8	3.99	-	-	F	M	M	C	C	XC	XC	287 to 968	239 to 798	180 to 599	144 to 479	120 to 399	103 to 342	90 to 299	80 to 266	72 to 239
	7	4.83	1.4	5.6	4.31	-	-	-	F	M	M	VC	VC	310 to 1034	259 to 862	194 to 647	155 to 517	129 to 431	111 to 369	97 to 323	86 to 287	78 to 259	
11010	1.5	2.90	0.5	1.0	2.28	-	VC	UC	-	-	-	-	-	164 to 547	137 to 456	103 to 342	82 to 274	68 to 238	59 to 195	51 to 171	46 to 156	41 to 137	
TTJ60 TTJ60	3	3.23	0.7	1.3	2.64	-	C	XC	-	-	-	-	-	190 to 634	158 to 528	119 to 396	95 to 317	79 to 264	68 to 226	59 to 198	53 to 176	48 to 168	
A1TTJ60	4	4.57	1.3	2.7	3.77	M	C	VC	VC	VC	UC	UC	UC	235 to 782	196 to 652	147 to 489	117 to 391	98 to 326	84 to 279	73 to 245	65 to 217	59 to 196	
(60)	5	5.11	1.6	3.4	4.21	M	M	C	C	VC	UC	UC	UC	271 to 905	226 to 754	170 to 566	136 to 452	113 to 377	97 to 323	85 to 283	75 to 251	68 to 228	
XR_XRC TT	6	5.59	1.9	4.1	4.81	-	M	C	C	VC	UC	UC	UC	303 to 1010	253 to 842	189 to 632	152 to 505	126 to 421	108 to 361	96 to 316	84 to 281	76 to 253	
TTI	7	6.04	2.2	4.8	4.88	-	-	C	C	C	VC	UC	UC	332 to 1108	277 to 922	207 to 692	166 to 553	138 to 461	119 to 395	104 to 346	92 to 307	83 to 277	
	2	3.86	0.9	1.1	2.83	-	-	UC	-	-	-	-	-	204 to 679	170 to 566	127 to 425	102 to 340	85 to 283	73 to 243	64 to 212	57 to 189	51 to 170	
	3	4.73	1.4	1.6	3.48	-	-	UC	-	-	-	-	-	251 to 835	209 to 696	157 to 522	125 to 418	104 to 348	89 to 298	78 to 261	70 to 232	63 to 209	
	4	5.46	1.8	2.2	4.02	-	-	XC	-	-	-	-	-	289 to 965	241 to 804	181 to 603	145 to 482	121 to 402	103 to 345	90 to 302	80 to 268	72 to 241	
	5	6.10	2.3	2.7	4.49	-	-	VC	-	-	-	-	-	323 to 1078	269 to 898	202 to 674	162 to 539	135 to 449	115 to 395	101 to 337	90 to 299	81 to 269	
	6	6.88	2.8	3.2	4.91	-	-	VC	-	-	-	-	-	354 to 1178	295 to 982	221 to 737	177 to 589	147 to 481	128 to 421	110 to 368	98 to 327	88 to 295	
	7	7.22	3.3	3.7	5.28	-	-	VC	-	-	-	-	-	390 to 1287	317 to 1056	239 to 792	190 to 634	158 to 528	138 to 453	119 to 396	106 to 352	95 to 317	

Table 10-14: Application Rates - US Page 2

Tip No. (Mesh Size)	Gauge Pressure (PSI)	Rated GPM	Δ P	Tip		Minimum Duty Cycle: 30%							Tip Spacing 20 Inches											
				PSI	Flow	T-J60	KRXRC	TT	TT-J60	AITT-J60	TT80	TTI	4 MPH GPA	6 MPH GPA	8 MPH GPA	10 MPH GPA	12 MPH GPA	14 MPH GPA	16 MPH GPA	18 MPH GPA	20 MPH GPA			
11006 XRXC TT T-J60 TT-J60 AITT-J60 TT80 TT TTI (60)	20	0.42	3	17	0.39	-	C	X/C	-	-	-	-	-	-	-	8.7 to 29	5.8 to 19.3	4.3 to 14.5	3.5 to 11.5	2.9 to 9.7	2.5 to 8.3	2.2 to 7.2	1.9 to 6.4	1.7 to 5.9
	30	0.52	4	26	0.48	-	M	V/C	V/C	-	-	-	-	-	-	10.7 to 36	7.1 to 24	5.3 to 17.8	4.3 to 14.3	3.6 to 11.9	3.1 to 10.2	2.7 to 8.9	2.4 to 7.9	2.1 to 7.1
	40	0.60	5	35	0.55	-	M	C	C	C	-	-	-	-	-	12.5 to 42	8.3 to 28	6.2 to 21	5.0 to 16.6	4.2 to 13.9	3.6 to 11.9	3.1 to 10.4	2.8 to 9.2	2.5 to 8.3
	50	0.67	6	44	0.63	-	M	M	M	C	V/C	V/C	-	-	-	14.0 to 47	9.4 to 31	7.0 to 23	5.5 to 18.7	4.7 to 15.6	4.0 to 13.4	3.5 to 11.7	3.1 to 10.4	2.8 to 9.4
	60	0.73	7	53	0.69	-	M	M	M	C	V/C	V/C	-	-	-	15.4 to 51	10.2 to 34	7.7 to 26	6.1 to 20	5.1 to 17.1	4.4 to 14.6	3.8 to 12.6	3.4 to 11.4	3.1 to 10.2
	70	0.79	8	62	0.74	-	M	M	M	C	V/C	V/C	-	-	-	16.5 to 56	11.0 to 37	8.2 to 27	6.5 to 22	5.5 to 18.3	4.7 to 15.7	4.1 to 13.7	3.7 to 12.2	3.3 to 11.0
	80	0.85	9	71	0.80	-	M	M	M	C	V/C	V/C	-	-	-	17.8 to 59	11.9 to 40	8.9 to 30	7.1 to 24	5.9 to 19.8	5.1 to 17.0	4.5 to 14.5	4.0 to 13.2	3.6 to 11.9
90	0.90	11	79	0.85	-	M	M	M	C	V/C	V/C	-	-	-	18.9 to 63	12.6 to 42	9.5 to 32	7.5 to 25	6.3 to 21	5.4 to 18.0	4.7 to 15.8	4.2 to 14.0	3.8 to 12.6	
11008 XRXC TT T-J60 TT-J60 AITT-J60 TT80 TT TTI (60)	20	0.67	5	15	0.50	-	C	X/C	-	-	-	-	-	-	11.1 to 37	7.4 to 25	5.6 to 18.6	4.5 to 14.9	3.7 to 12.4	3.2 to 10.6	2.8 to 9.3	2.5 to 8.3	2.2 to 7.4	
	30	0.69	6	24	0.51	-	C	V/C	V/C	V/C	-	-	-	-	13.6 to 45	9.1 to 30	6.8 to 23	5.4 to 18.1	4.5 to 15.1	3.9 to 12.9	3.4 to 11.3	3.0 to 10.1	2.7 to 9.1	
	40	0.80	8	32	0.71	-	M	C	C	C	V/C	V/C	-	-	15.8 to 53	10.5 to 35	7.9 to 26	6.3 to 21	5.3 to 17.8	4.5 to 15.1	4.0 to 13.2	3.5 to 11.7	3.2 to 10.5	
	50	0.89	10	40	0.79	-	M	M	M	C	V/C	V/C	-	-	17.6 to 59	11.7 to 39	8.8 to 29	7.0 to 23	5.9 to 19.6	5.0 to 16.8	4.4 to 14.7	3.9 to 13.0	3.5 to 11.7	
	60	0.96	12	48	0.87	-	M	M	M	C	V/C	V/C	-	-	19.4 to 65	12.9 to 43	9.7 to 32	7.9 to 26	6.5 to 22	5.5 to 18.5	4.8 to 16.1	4.3 to 14.4	3.9 to 12.9	
	70	1.06	14	56	0.94	-	M	M	M	C	V/C	V/C	-	-	21 to 70	14.0 to 47	10.5 to 35	8.4 to 28	7.0 to 23	6.0 to 19.9	5.2 to 17.4	4.7 to 15.5	4.2 to 14.0	
	80	1.13	16	64	1.01	-	M	M	M	C	V/C	V/C	-	-	22 to 75	15.0 to 50	11.2 to 37	9.0 to 30	7.5 to 25	6.4 to 21	5.5 to 18.7	5.0 to 16.7	4.5 to 15.0	
90	1.20	18	72	1.07	-	M	M	M	C	V/C	V/C	-	-	24 to 79	15.9 to 53	11.9 to 40	9.5 to 32	7.9 to 26	6.8 to 23	6.0 to 19.6	5.3 to 17.7	4.8 to 15.9		
11010 T-J60 TT-J60 AITT-J60 (60) XRXC TT TTI	30	0.87	10	20	0.71	-	C	X/C	X/C	V/C	V/C	-	-	15.8 to 53	10.5 to 35	7.9 to 26	6.3 to 21	5.3 to 17.8	4.5 to 15.1	4.0 to 13.2	3.5 to 11.7	3.2 to 10.5		
	40	1.00	13	27	0.82	-	C	V/C	V/C	V/C	V/C	-	-	18.3 to 61	12.2 to 41	9.1 to 30	7.3 to 24	6.1 to 20	5.2 to 17.4	4.5 to 15.2	4.1 to 13.7	3.7 to 12.2		
	50	1.12	16	34	0.82	-	M	V/C	V/C	V/C	V/C	-	-	20 to 68	13.7 to 46	10.2 to 34	8.2 to 27	6.8 to 23	5.9 to 19.5	5.1 to 17.1	4.6 to 15.2	4.1 to 13.7		
	60	1.22	19	41	1.01	-	M	M	V/C	V/C	V/C	-	-	22 to 75	15.0 to 50	11.2 to 37	9.0 to 30	7.5 to 25	6.4 to 21	5.6 to 18.7	5.0 to 16.7	4.5 to 15.0		
	70	1.32	22	48	1.09	-	M	M	C	V/C	V/C	-	-	24 to 81	16.2 to 54	12.1 to 40	9.7 to 32	8.1 to 27	6.9 to 23	6.1 to 20	5.4 to 18.0	4.9 to 16.2		
	80	1.41	25	55	1.17	-	M	M	C	V/C	V/C	-	-	26 to 87	17.4 to 58	13.0 to 43	10.4 to 35	8.7 to 29	7.4 to 25	6.5 to 22	5.8 to 19.3	5.2 to 17.4		
	90	1.50	29	61	1.24	-	M	M	C	V/C	V/C	-	-	28 to 92	18.4 to 61	13.8 to 46	11.0 to 37	9.2 to 31	7.9 to 26	6.9 to 23	6.1 to 20	5.5 to 18.4		
11012 TT	30	1.04	14	16	0.75	-	-	UC	-	-	-	-	-	15.9 to 56	11.3 to 38	8.5 to 28	6.9 to 23	5.6 to 19.8	4.8 to 16.1	4.2 to 14.1	3.8 to 12.5	3.4 to 11.3		
	40	1.20	18	22	0.88	-	-	UC	-	-	-	-	-	19.6 to 65	13.1 to 44	9.8 to 33	7.9 to 26	6.5 to 22	5.6 to 18.7	4.9 to 16.3	4.4 to 14.5	3.9 to 13.1		
	50	1.34	23	27	0.99	-	-	UC	-	-	-	-	-	22 to 74	14.7 to 49	11.0 to 37	9.8 to 29	7.4 to 25	6.3 to 21	5.5 to 18.4	4.9 to 16.3	4.4 to 14.7		
	60	1.47	28	32	1.08	-	-	UC	-	-	-	-	-	24 to 80	16.0 to 53	12.0 to 40	9.5 to 32	8.0 to 27	6.9 to 23	6.0 to 20	5.3 to 17.8	4.8 to 16.0		
	70	1.59	32	38	1.17	-	-	UC	-	-	-	-	-	26 to 87	17.4 to 58	13.0 to 43	10.4 to 35	8.7 to 29	7.4 to 25	6.5 to 22	5.8 to 19.3	5.2 to 17.4		
	80	1.70	37	43	1.24	-	-	UC	-	-	-	-	-	28 to 92	18.4 to 61	13.8 to 46	11.0 to 37	9.2 to 31	7.9 to 26	6.9 to 23	6.1 to 20	5.5 to 18.4		
	90	1.80	42	48	1.32	-	-	UC	-	-	-	-	-	29 to 98	19.6 to 65	14.7 to 49	11.9 to 39	9.2 to 31	8.4 to 28	7.4 to 25	6.5 to 22	5.9 to 19.5		

APPENDIX C – TROUBLESHOOTING GUIDE

Alert Code	Error	Description	Action
1002	Screen Resolution Alert	Display graphics are best seen on 480x480 screen resolution. Graphic representations may be affected below the recommended screen resolution.	Press the Accept key
1003	Softkey Size Alert	Due to size conformities, softkeys will use basic graphics.	Press the Accept key
1004	End User Licence Agreement	ALWAYS READ AND FOLLOW THE CHEMICAL LABEL'S DIRECTIONS. Droplet size classifications are based on BCPC specifications and in accordance with ASABE Standard S572.1. Classifications are subject to change. The chemical being sprayed, tank mixes, temperature, humidity, wind speed, vehicle speed, etc. can influence the actual drop size.	Press the Accept key Occurs on console power-up. Operator must press the Accept key to use the system
3002	Missing Start Terminator	Start terminator is not detected. Terminator is required for Operation Mode.	
3003	Missing End Terminator	End terminator is not detected. Terminator is required for Operation Mode.	
3004	Missing Solenoid	One or more Solenoids are not detected. Solenoid is required for Operation Mode.	Go to System Overview for details
3005	Voltage Too High	Driver voltage is above the high voltage limit.	Go to System Overview for details.
3006	Voltage Too Low	Driver voltage is below the low voltage limit.	Go to System Overview for details.
3007	Solenoid Current Too High	Solenoid current is above the high current limit.	Go to System Overview for details.
3008	Solenoid Current Too Low	Solenoid current is below the low current limit.	Go to System Overview for details.
3009	Missing Pressure Sensor	Pressure sensor is not detected. Pressure sensor is required for Operation Mode.	
3010	Missing Boom Interface Module	Communication to the Boom Interface Module has been lost. Boom Interface Module is required for Operation Mode.	
3011	Missing IOM Pressure Sensor	Communication to the Input Output Module (IOM) Pressure Sensor has been lost. IOM. Pressure Sensor is required for Operation Mode	
3012	Missing Driver(s)	Communication to a driver or drivers has been lost. All drivers are required for Operation Mode.	Go to System Overview for details.
3015	Minimum Duty Cycle Reached	Desired pressure is not being maintained by the system. The control duty cycle has fallen to the minimum threshold.	
3016	Above Maximum Duty Cycle	Desired pressure is not being maintained by the system. The control duty cycle has risen above the maximum threshold.	
3017	Above High Pressure	System pressure is above the high pressure alarm value. The duty cycle has reached the maximum and pressure is still too high.	
3018	Outside Droplet Size	Droplet size is not being maintained by the system.	
3019	Above High Pressure	System pressure is above the high pressure alarm value.	
3020	Below Low Pressure	Nozzle pressure is below the recommended nozzle pressure range.	
3021	Above High Pressure	Nozzle pressure is above the recommended nozzle pressure range.	
3022	Boom Setup Error	Number of implement nozzles and flow regulator nozzles are mismatched.	Go to Main Menu-> Machine Setup for details.

Alert Code	Error	Description	Action
3024	ECU Suite Version Inconsistent	The ECU suite version is not included in the driver module firmware version.	See Main Menu-> Help-> About screen for driver version and ECU Suite version. Update the driver module to include current ECU suite version.
3025	General Nozzle Selected	A General nozzle has been selected. Droplet Mode and Pressure Mode not available.	
3026	User Defined Nozzle Selected	A User Defined nozzle has been selected. Droplet Mode and Pressure Mode not available.	
3028	At Initialisation, the following errors may have occurred: <ul style="list-style-type: none"> • 3002 Missing Start Terminator • 3003 Missing End Terminator • 3004 Missing Solenoid • 3009 Missing Pressure Sensor • 3013 Driver Versions Inconsistent • 3022 Boom Setup Error • 3023 Number of Sections Error • 3024 ECU Suite Version <i>NOTE: This alert replaces the above pop-ups ONLY at Initialisation.</i>	At least one or more initialisation errors has occurred.	Go to System Overview for details on the error(s). Once all errors have been addressed, restart the system.
3029	Operation Error: All Solenoids Open	An issue on the system has occurred preventing access to the Operation screen. To avoid additional issues, all Solenoids have been opened.	Please stop application and address the operation issue.

DYNAJET® IC7140

INSTALLATION/SETUP/USER MANUAL

Key Features and Benefits:

- Nozzles operate on/off at 20 Hz frequency
- Alternating nozzles ensure proper spray coverage
- High flexibility without changing nozzles
 - Accommodate various application rates
 - Increased speed range for higher productivity
 - Adjust droplet size on-the-go
- Flow rate (litre/minute or gallon/minute) determined by Duty Cycle
 - For example 50% (50% On & Off), turns an 05 nozzle to an 025
- 90% drift reduction with AIC11005 VP/VS or AITTJ6011004 VP
- Optional: ISOBUS technology with turn compensation



A Subsidiary of  *Spraying Systems Co.*

www.teejet.com