

**OPERATORS MANUAL  
FOR THE  
LH "INTELLITRAM" 500**

LH No. 020-505-UK Version 1.00

**LH Technologies Denmark ApS**

Mølhavevej 2  
9440 Aabybro  
Denmark

Tlf. +45 9696 2500

Fax. +45 9696 2501

Internet: <http://www.lh-agro.com/>



# Contents

INTRODUCTION .....	5
OVERVIEW .....	7
OPERATING THE LH 500 .....	8
HOLD KEY (POS. 1) .....	8
FUNCTION SELECTION KEY (POS. 2).....	8
MENU KEY (POS. 3).....	8
ARROW KEYS (POS. 4) .....	8
ENTER KEY (POS. 5) .....	9
ESCAPE KEY (POS. 6).....	9
CLEAR KEY (POS. 7) .....	9
PROGRAM KEYS (POS. 8) .....	9
CURSOR (POS 9).....	9
OPERATION.....	10
OPERATING SCREEN .....	10
INDICATION OF THE TRAMLINING RHYTHM .....	10
HOLD FUNCTION.....	10
IMPLEMENT SENSOR STATUS .....	10
OPERATION FUNCTION 1 & 2 .....	10
MANUAL CONTROL OF THE PRESENT BOUT NUMBER .....	10
USER SELECTABLE OPERATION FUNCTIONS .....	11
FORWARD SPEED .....	11
AREA .....	11
HA/HOUR.....	11
TIME .....	11
KG COUNTER .....	11
KG LEFT .....	12
KG/HA.....	12
DISTANCE.....	12
FAN SPEED.....	12
OPERATION WARNINGS.....	12
ENCODE .....	13
KG LEFT .....	13
TRAMLINING RHYTHM.....	13
SHOW PRESENT RHYTHM.....	13
CALCULATE NEW RHYTME.....	13
CALIBRATION .....	14
GRAM/PULSE.....	14
NEW CALIBRATION.....	14
WARNINGS.....	14
CLUTCH LEFT/RIGHT.....	14
DRILL SHAFT .....	15

EMPTY HOPPER.....	15
KG LEFT .....	15
FAN SPEED.....	15
MACHINE SETTINGS.....	15
WORKING WIDTH.....	15
FORWARD SPEED SENSOR .....	16
AUTOMATIC FORWARD SPEED CALIBRATION.....	16
IMPLEMENT SENOR .....	16
RPM SENSOR.....	17
NUMBER OF ROWS .....	17
ROWS IN TRACK .....	17
RETURNS.....	18
STOPWATCH .....	18
INFO .....	19
DATA/DELETE (TASKS).....	19
THE COUNTERS IN A TASK.....	20
START/CONTINUING A TASK .....	20
RESETTING A TASK.....	21
SYSTEM.....	22
CONTRAST/LIGHT .....	22
LANGUAGE .....	22
MACHINE TYPE .....	22
IMPLEMENT SENSOR DELAY.....	22
SOFTWARE-INFO .....	22
TEST .....	23
TEST INPUT .....	23
TEST OUTPUT .....	23
TRAMLINING RHYTHMS .....	24
SYMMETRIC TRAMLINING RHYTHMS .....	24
RIGHT/LEFT TRAMLINING RHYTHMS.....	26
SPECIAL TRAMLINING RHYTHMS .....	29

---

## INTRODUCTION

---

Thank you for choosing a LH product.

Whilst developing the LH "Intellitram" 500 we have tried to create an advanced product that, at the same time, is easy to operate.

The LH "Intellitram" 500 has many user selectable functions and meets therefore almost all thinkable combinations of different working widths of seed drills and cultivating equipment, i.e. field sprayers and fertiliser spreaders.

**It is not essential to read the whole operators manual now**, but to help you start "communicating" with the computer, we recommend that you read the "General operation" chapter **before** you turn the computer on.

It's never a good idea to learn how to operate the computer on the first day that it is to be used. We recommend therefore to "practice" to get used to "pushing buttons" before the computer is to be used.

Many of the functions in the computer are self-explanatory. This eases operation of the unit and allows you to operate the computer without this manual after a few hours work. We do however recommend that this manual is "in reach" should you be in doubt.

Enjoy!

*We have endeavoured to deliver a fault free product. To ensure optimal use of the equipment we ask that great attention be paid when reading the manual. We are more than happy to help should any queries arise, both when the product is used for the first time and at any later date. Regarding responsibility for use of the product we refer to our sales and delivery terms especially paragraph 7, which follows:*

7. Product usage.

7.1 Any use of the product is at the sole risk of the buyer. The buyer is therefore not entitled to any form for compensation caused by, for example, any of the following:

- Disturbance to/from any electronic services or products that do not confirm to the standards for CE marking,
- Missing or poor signal coverage or a succession hereof from external transmitters/receivers, used by the buyer,
- Functional faults, which apply to or from a PC-program or PC-equipment, not delivered by the seller,
- Faults that may arise from the buyers negligence to react to warnings and fault messages from the product, or which can be traced to negligence and/or absent constant control of the work carried out in comparison to the planned job.

7.2 When implementing any new equipment the buyer must take great care and pay attention. Any doubts as to correct operation/use should result in contacting the sellers service department.

This manual may not be altered, copied or manipulated in any way. Unoriginal manuals can lead to operational faults damaging machines or crops as a consequence thereof. LH Technologies Denmark ApS can therefore not be held responsible for damages incurred, which can be traced to the use of unoriginal or manipulated manuals. Original manuals can be requisitioned at any time from your dealer.

With regards

**LH Technologies Denmark ApS**

**Mølhavevej 2**

**9440 Aabybro**

**Denmark**

**Tel. +45 96 96 25 00**

**Fax. +45 96 96 25 01**

**Internet: <http://www.lh-agro.com/>**

# OVERVIEW

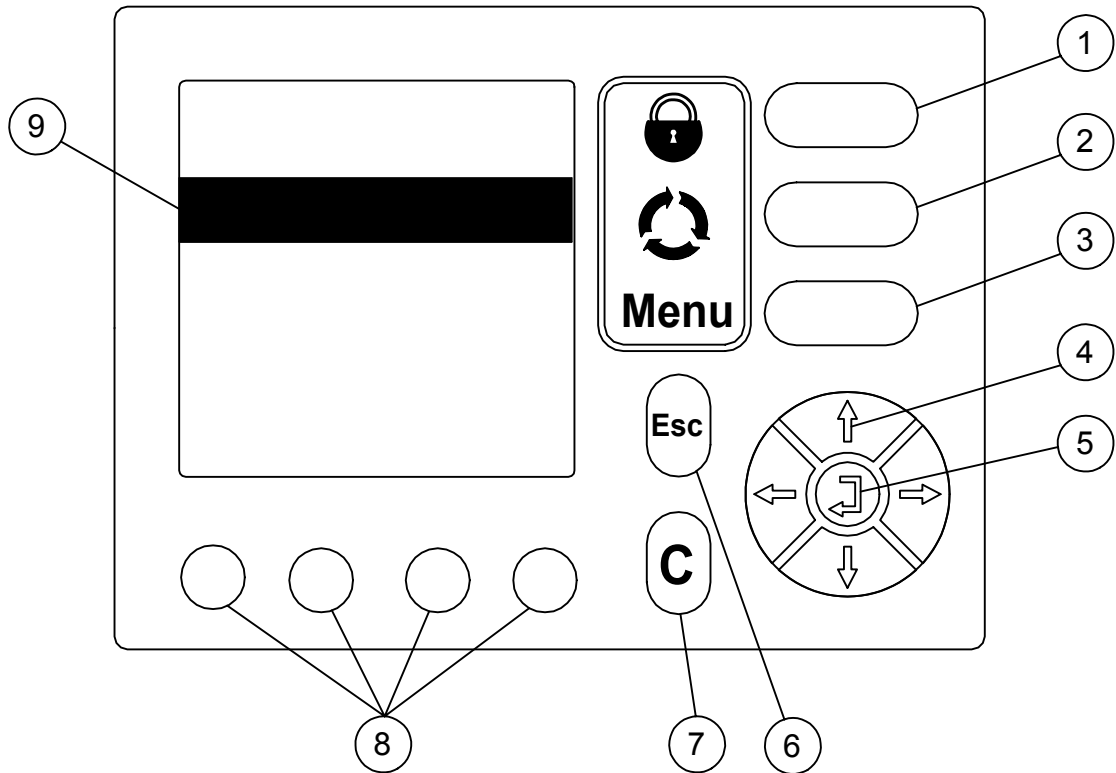

Pos.	Description
1	Hold key
2	Function selection key
3	Menu key
4	Arrow keys
5	Enter key
6	Escape key
7	Clear key
8	Program keys
9	Cursor

## OPERATING THE LH 500

### HOLD KEY (POS. 1)

Key	Description
	Pressing this key stops the bout number from being counted. The implement can be lifted without the bout number changing. This function is typically used if the seed drill must be raised for an obstruction. Once the obstruction has been cleared, press the HOLD key again and the bout number will be counted automatically again. When this function is active an icon will be displayed on the screen.

### FUNCTION SELECTION KEY (POS. 2)

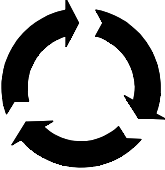
Key	Description
	Pressing this key pages through the available operating functions. An operating function is automatically selected – it is not necessary to press other keys to accept the selected function.

### MENU KEY (POS. 3)

Key	Description
<b>Menu</b>	The computer alternates between the operating screen and the main menu each time this key is pressed. The key has a toggle function so if the operating screen is shown and the key is pressed the main menu will be displayed instead and visa versa. If the key is pressed whilst, e.g. encoding, the operating screen will be displayed.

### ARROW KEYS (POS. 4)

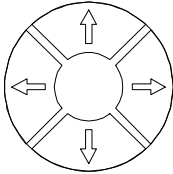
Key	Description
	The arrow keys are used to select and alter an encodement. The UP and DOWN arrow keys are also used to move the cursor in the operating screen, which allows moving between the 2 selectable operating functions.

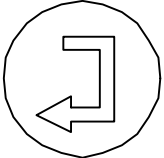

**ENTER KEY (POS. 5)**

Key	Description
	The enter key is used to accept encodements and to return to the previous screen.

**ESCAPE KEY (POS. 6)**

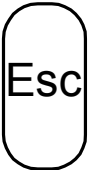
Key	Description
	Use this key to return to the previous menu <b>without</b> saving the value.

**CLEAR KEY (POS. 7)**

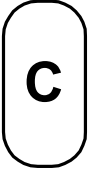
Key	Description
	The clear key is used to reset encodements/counters and to clear warnings.

**PROGRAM KEYS (POS. 8)**

Key	Description
 Key 1 - 4	The function of the program keys are shown on the display directly over the program key. These keys are used for, amongst other things, to manually alter the present bout number in the tramlining rhythm – manual control tramlining control.

**CURSOR (POS 9)**

The cursor is shown on the screen as a black bar. When the field on the screen is marked (the cursor is on the field) the field is active – changes will apply to the marked field.

## OPERATION

Pressing the MENU key, regardless of where you are in the program, shows the operating screen. The operating screen is always displayed when the computer is switched on.

**Correct operation presupposes that all encodements/calibrations have taken place (see page 13).**

### OPERATING SCREEN

The operating screen can be split up into the following sections. A description of the sections follows:

Indication of the tramlining rhythm.		<i>The actual bout number is marked with a black triangle.</i>
Active hold function (pause in the tramlining rhythm)		Operation function 1 (selectable)
Implement sensor status ( <i>area count on/off</i> ).		Operation function 2 (selectable)
Manual control of the tramlining rhythm.		Manual control of the tramlining rhythm.

### INDICATION OF THE TRAMLINING RHYTHM

An indication of the present bout number in the tramlining rhythm. The present bout number is shown with a black triangle. If tramlines are being made lines are shown on the screen indicating this (these indicate which output is activated).

### HOLD FUNCTION

If the hold function is active (manual pause in the tramlining rhythm) a lock is shown on the display. The lock is not shown when the hold function is not active.

### IMPLEMENT SENSOR STATUS

When the raised lift arm is displayed on the screen the implement sensor is active and area is **not** counted. If the lift arm is not displayed on the screen the implement sensor is not active and area is counted.

### OPERATION FUNCTION 1 & 2

Both of these operation functions are user selectable. Pressing either the ARROW UP or ARROW DOWN keys moves the cursor between the 2 screen sections. Repeatedly pressing the FUNCTION SELECTION key pages through the available functions (see page 11).

### MANUAL CONTROL OF THE PRESENT BOUT NUMBER

When PROGRAM key 1 (to the left) is pressed the present bout number will decrease by 1. When PROGRAM key 2 (to the right) is pressed the present bout number will increase by 1.

## USER SELECTABLE OPERATION FUNCTIONS

Repeatedly pressing the FUNCTION SELECTION key pages through the available operation functions. Each individual function is described in the following:

### FORWARD SPEED

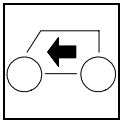
Key	Description
	The present forward speed shown in kilometres per hour.

### AREA

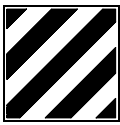
Key	Description
	The worked area since the last reset (see page 19), displayed in ha. The area counter is shown with 2 decimals until 99.99 ha. The area counter is shown with 1 decimal thereafter until 999.9 ha. Area is displayed with no decimals thereafter.

### HA/HOUR

Key	Description
	The present working efficiency shown as ha/hour.

### TIME

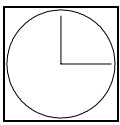
Key	Description
	The current time.

### KG COUNTER

Key	Description
	The amount sown since the last reset (see page 19). The amount is shown in kg until 9999 kg and then as tons (99.99, 999.9, 9999). When the amount counted changes from kg to ton this is indicated on the display with a "T" in the weight icon.

**KG LEFT**

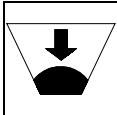
Key	Description
	The amount remaining in the seed hopper (presupposes that the amount filled into the hopper has been encoded, see page 13).

**KG/HA**

Key	Description
	The present seed rate shown as kg/ha.

**DISTANCE**

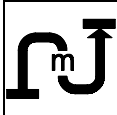
Key	Description
	The driven distance since the last reset (see page 19). The distance driven is shown as metres up to 9999 m, thereafter as km (99.99, 999.9, 9999). When the distance counter changes to km the icon changes to show "km" instead of "m".

**FAN SPEED**

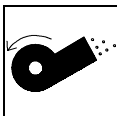
Key	Description
	<i>Only displayed if pneumatic seed drill has been selected under machine type in the system menu (see page 22).</i> The fan speed shown as RPM.

**OPERATION WARNINGS**

Different situations under operation can cause a warning to be given. The different warnings are cleared/accepted by pressing the "C" key.

A description and the procedure for encoding the different warnings can be seen on page 14.

***A warning is given for a reason! Check therefore the reason for the warning before clearing.***

---

## ENCODE

---

The encodement menu is selected from the main menu (press the menu key). Use hereafter the ARROW UP and ARROW DOWN keys to mark "**Encode**". Press thereafter the ENTER key. The same principle is used to select the individual encodement menus.

***The machine type and the implement sensor delay must be encoded first. These encodements are found in the system menu (see page 22).***

***Encode the machine settings next as these are machine related and need only be encoded once.***

### KG LEFT

To see how much seed is left in the hopper, the amount filled must be encoded here. This value can be reset by pressing the "C" key.

If there is seed remaining in the hopper when filling then this amount must be added to the amount filled as follows:

**Amount remaining + new amount filled = kg left (total amount in hopper)**

### TRAMLINING RHYTHM

For more information on the different tramlining rhythms see page 24.

### SHOW PRESENT RHYTHM

Information on the currently selected rhythm can be seen here.

### CALCULATE NEW RHYTME

The procedure for calculating a new rhythm is as follows:

1. Move the cursor to "**Calculate new rhythm**" and press the ENTER key.
2. Encode the working width of the implement used to cultivate the crop and press the ENTER key.
3. Define where the clutches (traditional machines) or shutters (pneumatic machines) are fitted and press the ENTER key.
4. Move the cursor to "**Calculate new rhythm**" – press the ENTER key and a new rhythm is automatically calculated.
5. Check the values shown. Attention should be paid to whether the field should be started on the left or on the right side (see page 24 for more information).

## CALIBRATION

### GRAM/PULSE



The weight, in gram, per pulse can be encoded directly if known.

### NEW CALIBRATION

The procedure for calibration is thus:

1. Move the cursor to "**New calibration**" and press the ENTER key.
2. Turn the drill shaft a suitable number of rotations (see the seed drill instruction book), the computer counts the number of pulses. Press the ENTER key when finished.
3. Weigh the amount released (exactly) and enter this weight. Press the ENTER key.
4. The calculated weight per pulse is now shown on the display.

## WARNINGS

Key	Description
	Warning on.
	Warning off.

### CLUTCH LEFT/RIGHT

The clutch warning is given if tramlines are made when they should not be and visa versa.

Encode whether the warning is active (**on**) or not active (**off**). Use the program keys 1 & 2 to switch the warning on or off.

These warning encodements are not shown if pneumatic seed drill has been selected under machine type in the system menu (see page 22).

## DRILL SHAFT

The drill shaft warning is given if the drill shaft stops rotating.

Encode whether the warning is active (**on**) or not active (**off**). Use the program keys 1 & 2 to switch the warning on or off.

*On most seed drills the drill shaft can be adjusted to rotate very slowly (1 rev. per 100 m). For the clutch and drill shaft warnings the minimum speed per minute is set to 0.6. the time that passes from when the pulses stop to the warning is given is directly dependant on the number of pulses per revolution given from the drill shaft sensor. The more pulses given per revolution will therefore give a faster warning. An RPM sensor that gives 12 pulses per revolution will be suitable for seed drills with such a slow drill shaft.*

## EMPTY HOPPER

If the seed hopper is fitted with an empty hopper sensor a warning will be given when the hopper is empty.

Encode whether the warning is active (**on**) or not active (**off**). Use the program keys 1 & 2 to switch the warning on or off.

## KG LEFT

The Kg left warning is given is lower than the amount encoded.

Encode whether the warning is active (**on**) or not active (**off**). Use the program keys 1 & 2 to switch the warning on or off.

The amount, at which the warning should be given, is encoded as kg.

## FAN SPEED

The fan speed warning is given when the fan speed is lower than the encoded speed.

Encode whether the warning is active (**on**) or not active (**off**). Use the program keys 1 & 2 to switch the warning on or off.

The fan speed, at which the warning should be given, is encoded as RPM.

## MACHINE SETTINGS

### WORKING WIDTH

The working width of the seed drill encoded in centimetres.

### FORWARD SPEED SENSOR

Selection of the forward speed sensor plus the speed calibration figure can be encoded here. It is also possible to automatically calibrate the forward speed sensor.

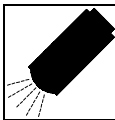
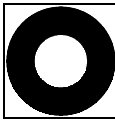
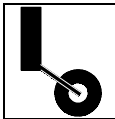
Key	Description
	Pressing this key (program key 1) selects Radar as the speed sensor (via the 7-pin DIN/ISO socket). <i>If the number of pulses per 100 m is known it can be encoded directly.</i>
	Pressing this key (program key 2) selects a wheel sensor fitted on the tractor as the speed sensor (via the 7-pin DIN/ISO socket). <i>If the number of pulses per 100 m is known it can be encoded directly.</i>
	Pressing this key (program key 3) selects a wheel sensor fitted to the seed drill as the forward speed sensor. <i>If the number of pulses per 100 m is known it can be encoded directly.</i>

### AUTOMATIC FORWARD SPEED CALIBRATION

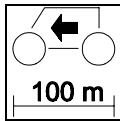
Step/Key	Description
1	Measure a 100-metre stretch and drive to the start mark.
2	Select the speed sensor as described above.
3 	Press this key and drive the measured 100-metre stretch. Stop exactly at the stop mark. <i>The computer counts pulses received whilst driving.</i>
4	Press the ENTER key and forward speed calibration is finished.

### IMPLEMENT SENSOR

The implement sensor “tells” the computer whether area should be counted or not. Each time the implement sensor is activated the tramlining bout number increases by 1.

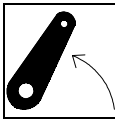
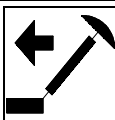
Key	Description
	Pressing this key (program key 1) selects the implement signal coming from the 7-pin DIN/ISO socket in the tractor.
	Pressing this key (program key 2) selects the implement signal from a sensor fitted on the seed drill.



**RPM SENSOR**

The number of pulses per revolution for the following rpm sensors is encoded her:

**Clutch left, clutch right, drill shaft and fan.**

**NUMBER OF ROWS**

Encode the total number of rows on the seed drill.

**ROWS IN TRACK**

Encode the number of rows closed, **per track**, when tramlines are made.

## RETURNS

Only on pneumatic seed drills.

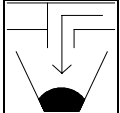
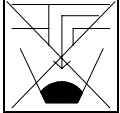
Key	Description
	<p>If the seed to the closed rows (when making tramlines) is returned to the hopper then select <b>on</b>.</p>
	<p>If the seed to the closed rows (when making tramlines) is distributed to the other rows then select <b>off</b>.</p>

## STOPWATCH

Select whether the stopwatch should be started and stopped with the implement sensor (select "**Implement sensor**") so time is only registered when the seed drill is working.

If "**None**" is selected the stopwatch will run from the moment the computer is switched on until the stopwatch is reset or the computer is switched off (see page 19).

---

## INFO

---

The information menu gives an overview of different encodements and is selected from the man menu (press the MENU key). Use the ARROW UP and ARROW DOWN keys to mark "Info". Press thereafter the ENTER key.

Pressing the ARROW UP and ARROW DOWN keys pages through the following two screens:

Info	
Kg left	0
Trip counter no.	1
Width (cm)	400
Pulses./100m	97
Rhythm	3
↓	↓
↓	↓

Info		
↑	↑	↑
Rows	38	
Rows in track	4	
Returns	off	

---

## DATA/DELETE (TASKS)

---

It is possible to have up to ten different trip counter sets (tasks) that can be started and stopped when, e.g. changing fields.

The task menu is selected from the main menu (press the MENU key). Press hereafter the ARROW UP and ARROW DOWN keys to mark "Data/delete". Press the ENTER key.

When starting a new task all the counters are zeroed. If another task is selected and then the original task is selected again the counters will continue with the same values from when the task was stopped.

The tasks can be reset one by one.

## THE COUNTERS IN A TASK

Trip counter 1/10	
New counter	
Delete counter	
Kg	0
Time	0:00:00
Ha	0.00
Metre	0

The screen to the left is displayed when the "Data/delete" menu is selected. A description of each individual counter follows:

### Kg:

The total amount, in kg, since the task was started or since the counter was reset.

### Time:

The total time since the task was started or since the counter was reset. How time is measured is dependant on the STOPWATCH encodement (see page 18).

If "None" has been selected time will be measured from when the task is started until the task is stopped or the counter is reset.

If "Implement" has been selected time will be measured when the seed drill is working, i.e. only when sowing.

### Ha:

The total area, in ha, since the task was started or since the counter was reset. The measured area is the effective area, i.e. only the area that has been sown.

### Metre:

The distance driven (effective distance) in metres since the task was started or since the counter was reset.

## START/CONTINUING A TASK

When selecting the "Data/delete" menu the previously opened task is "opened

Trip counter	
Counter no.	1
Counter no.	2
Counter no.	3
Counter no.	4
Counter no.	5
Counter no.	6
↓	↓
↓	↓

To start or continue a task highlight "New counter" and press the ENTER key. Task 1 – 10 can now be selected by using the ARROW UP and ARROW DOWN keys to mark the required task number and then press the ENTER key.

To return to the main operating screen press the MENU key.

## RESETTING A TASK

If the counters in a task are to be reset, select the task as described above and highlight "**Delete counter**", press thereafter the ENTER key.

## SYSTEM

The system menu is selected from the main menu (press the MENU key). Use the ARROW UP and ARROW DOWN keys to highlight "**System**" and press the ENTER key.

### CONTRAST/LIGHT

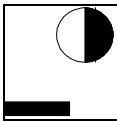
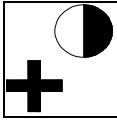
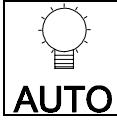
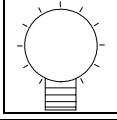
Key	Description
	Pressing this program key will make the screen lighter.
	Pressing this program key will make the screen darker.
	Pressing this program key will activate the auto-light function. The backlight is switched off until a key is pressed, the backlight will be switched on automatically.
	The display's backlight is turned on and off with this program key.

### LANGUAGE

The operating language of the LH "Intellitram" 500 is selected here.

### MACHINE TYPE

Select whether the seed drill is "**Standard**" or "**Pneumatic**".

### IMPLEMENT SENSOR DELAY

Encode a delay, in seconds, from when the implement sensor is activated until the bout number is increased in the tramlining rhythm. Encoding 0 gives no delay. The max. delay that can be encoded is 10 seconds.

The implement sensor delay stops the bout number being counted when, i.e. faulty pulses from the implement sensor.

### SOFTWARE-INFO

The current operating software version number for the LH "Intellitram" 500 can be seen.

## TEST

### TEST INPUT

Test input can be used if

Directly under each input description, to the right, is a counter that registers the number of time the input has been activated (the counter is reset automatically each time "Test input" is exited or by pressing the C key). On the left-hand side the actual status of the input is shown (**Hi/Lo**).

All of the different inputs can be seen by pressing the ARROW UP and ARROW DOWN keys to page through the 3 screens.

The different input descriptions relate to the following:

Input	Description
Wheel/tractor	Forward speed signal from the sensor fitted on the tractor.
Radar	Forward speed signal from the radar fitted on the tractor.
Wheel implement	Forward speed signal from the sensor fitted on the seed drill.
<b>Press the ARROW DOWN key to see the next inputs:</b>	
Implement sensor/tractor	Implement signal (area on/off) from the implement sensor fitted on the tractor (via the 7-pin DIN/ISO plug in the tractor).
Impl. sensor /implement	Implement signal (area on/off) from the implement (seed drill).
Clutch left /fan	Signal from the RPM sensor fitted to the left clutch or signal from the RPM sensor fitted to the fan on pneumatic machines.
<b>Press the ARROW DOWN key to see the next inputs:</b>	
Clutch right	Signal from the RPM sensor fitted to the right clutch.
Drill shaft	Signal from the RPM sensor fitted on the drill shaft.
Level sensor	Signal from the hopper lever sensor.

### TEST OUTPUT

Each individual output can be tested. Press the program key number for the following test:

Output	Description
Left clutch 1	Activation of the left clutch or signal to open the left valve on pneumatic seed drills.
Left clutch 2	Signal to close the left valve on pneumatic seed drills.
Right clutch 1	Activation of the right clutch or signal to open the right valve on pneumatic seed drills.
Right clutch 2	Signal to close the right valve on pneumatic seed drills.

## TRAMLINING RHYTHMS

There are many different possible combinations of different drill widths and cultivating equipment. To meet these needs the following tramlining rhythms are available.

### SYMMETRIC TRAMLINING RHYTHMS

Common for all symmetric tramlining rhythms is that the shut off mechanisms are fitted symmetrically on the **middle** of the machine.

#### Rhythm 2S:

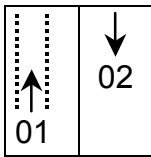

#### Rhythm 3S:

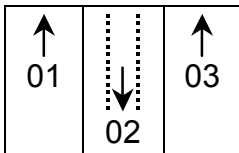

#### Rhythm 4S:

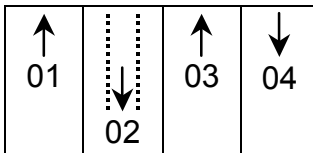

#### Rhythm 5S:

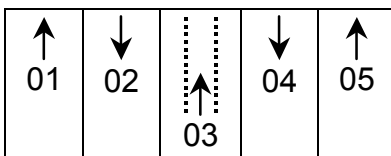

#### Rhythm 6S:

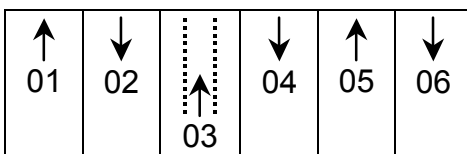

#### Rhythm 7S:

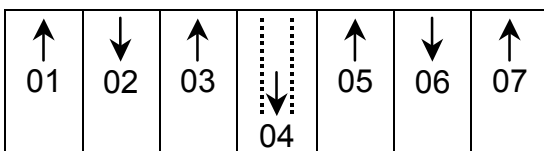



**Rhythm 8S:**

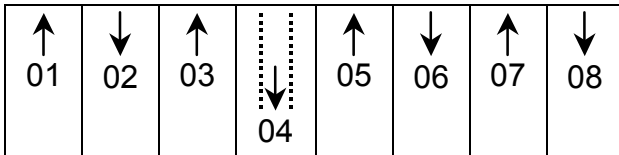

**Rhythm 9S:**

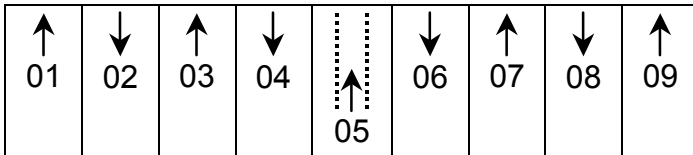

**Rhythm 10S:**

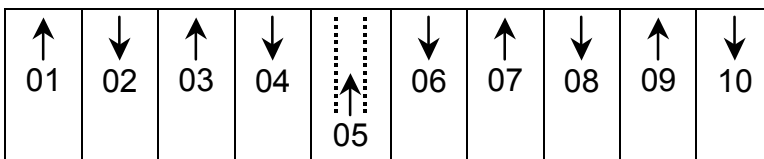

**Rhythm 11S:**

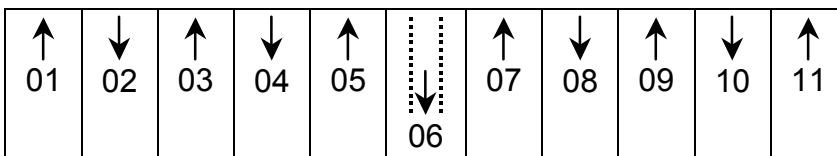

**Rhythm 12S:**

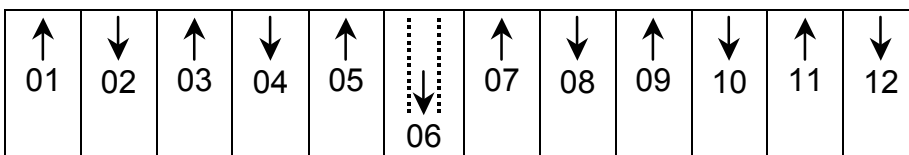

**Rhythm 13S:**

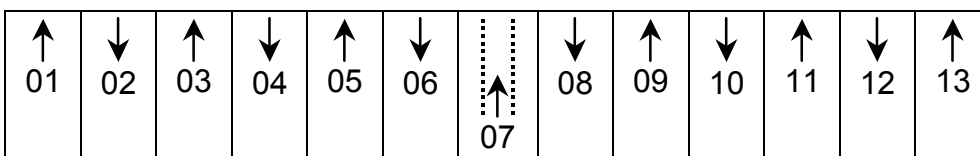

**Rhythm 14S:**

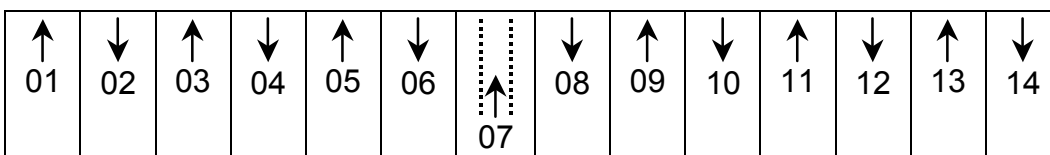

**Rhythm 15S:**

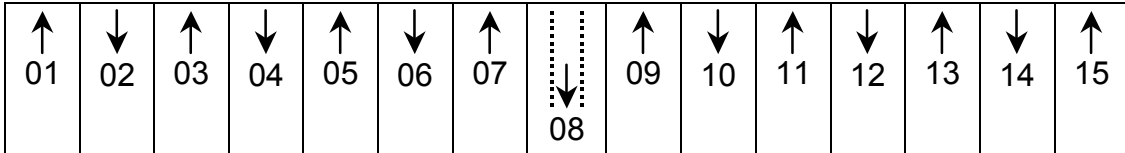

**Rhythm 16S:**

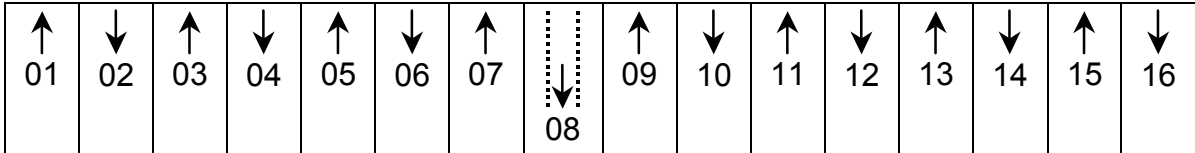

**Rhythm 17S:**

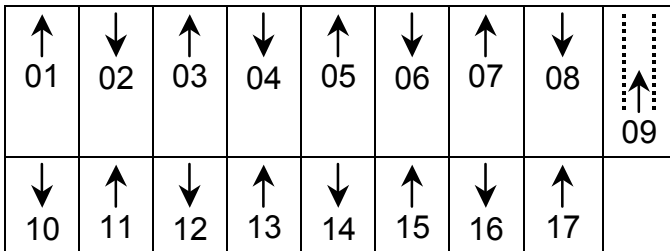

**RIGHT/LEFT TRAMLINING RHYTHMS**

Common for the following tramlining rhythms is that the shut off mechanisms are fitted on either the left- or the right-hand side of the machine.

The width of the equipment divided by the seed drill width must be an **equal** number.

**Note!** Sowing **must** be started on the side of the field as given.

**Rhythm 2 left/right:**

Shut off = **left** side, start the field on the **right-hand** side.

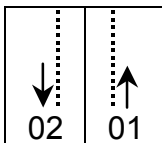

Shut off = **right** side, start the field on the **left-hand** side.

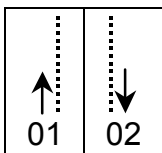

**Rhythm 4 left/right:**

Shut off = **right** side, start the field on the **right-hand** side.

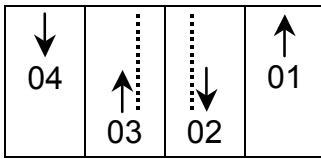

Shut off = **left** side, start the field on the **left-hand** side.

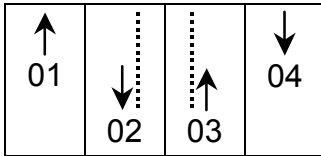

**Rhythm 6 left/right:**

Shut off = **left** side, start the field on the **right-hand** side.

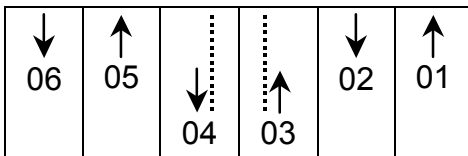

Shut off = **right** side, start the field on the **left-hand** side.

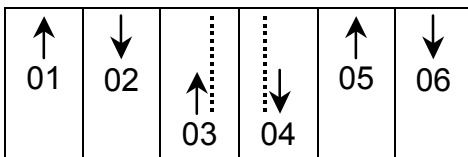

**Rhythm 8 left/right:**

Shut off = **left** side, start the field on the **right-hand** side.

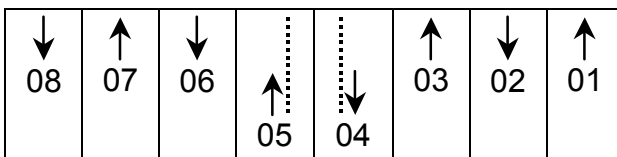

Shut off = **right** side, start the field on the **left-hand** side.

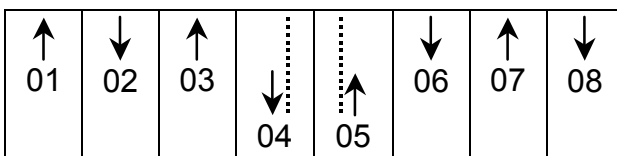

**Rhythm 10 left/right:**

Shut off = **left** side, start the field on the **right-hand** side.

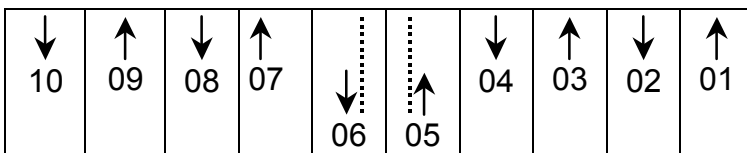

Shut off = **right** side, start the field on the **left-hand** side.

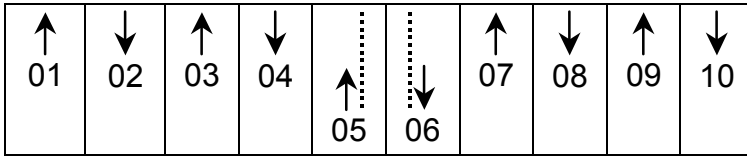

**Rhythm 12 left/right:**

Shut off = **left** side, start the field on the **left-hand** side.

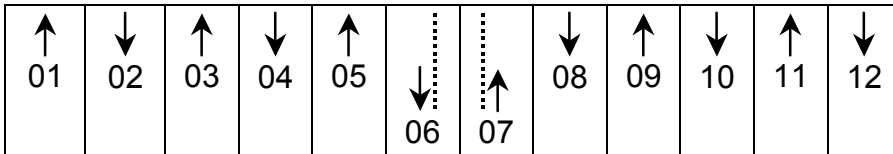

Shut off = **right** side, start the field on the **right-hand** side.

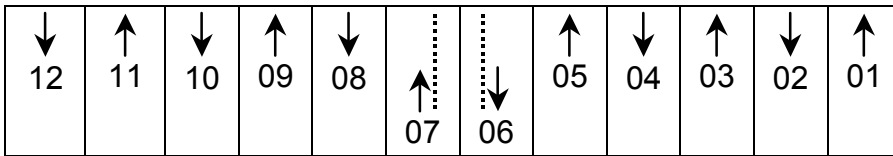

**Rhythm 14 left/right:**

Shut off = **right** side, start the field on the **left-hand** side.

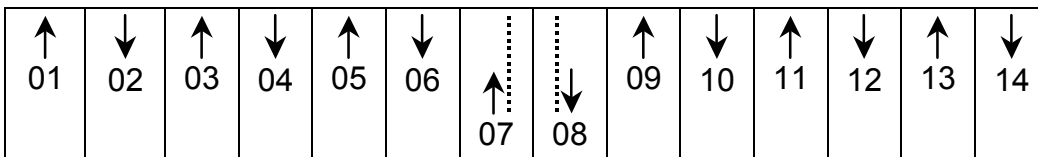

Shut off = **left** side, start the field on the **right-hand** side.

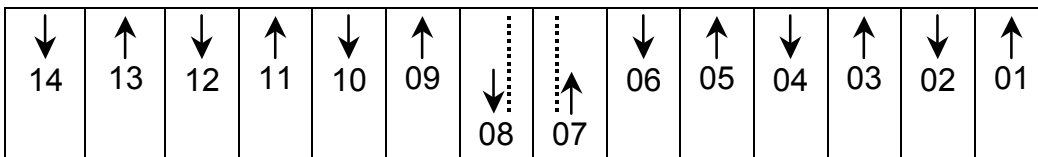

**Rhythm 16 left/right:**

Shut off = **left** side, start the field on the **left-hand** side.

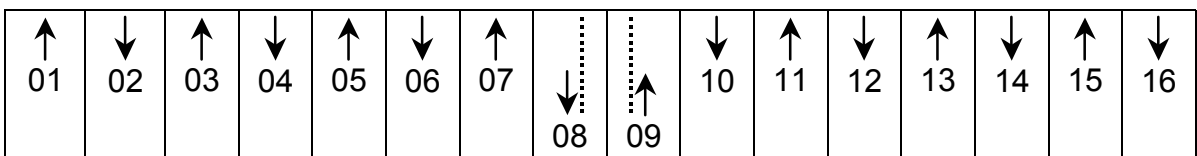

Shut off = **right** side, start the field on the **right-hand** side.

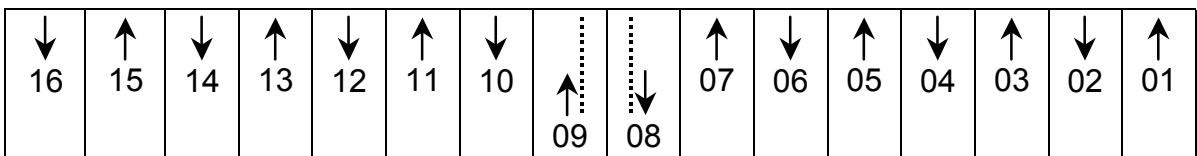

**Rhythm 18 left/right:**

Shut off = **right** side, start the field on the **left-hand** side.

↑ 01	↓ 02	↑ 03	↓ 04	↑ 05	↓ 06	↑ 07	↓ 08	↑ 09
↓ 10	↑ 11	↓ 12	↑ 13	↓ 14	↑ 15	↓ 16	↑ 17	↓ 18

Shut off = **left** side, start the field on the **right-hand** side.

↓ 18	↑ 17	↓ 16	↑ 15	↓ 14	↑ 13	↓ 12	↑ 11	↓ 10
↑ 09	↓ 08	↑ 07	↓ 06	↑ 05	↓ 04	↑ 03	↓ 02	↑ 01

**SPECIAL TRAMLINING RHYTHMS**

**Rhythm 28 Left:**

3 metre seed drill/28 metre cultivating equipment.

Shut off = **2 x right** & **1 x left** side, start the field on the **left-hand** side.

↑ 01	↓ 02	↑ 03	↓ 04	↑ 05	↓ 06	↑ 07	↓ 08	↑ 09	↓ 10	↑ 11	↓ 12	↑ 13	↓ 14
↑ 15	↓ 16	↑ 17	↓ 18	↑ 19	↓ 20	↑ 21	↓ 22	↑ 23	↓ 24	↑ 25	↓ 26	↑ 27	↓ 28

**Rhythm 28 Right:**

3 metre seed drill/28 metre cultivating equipment.

Shut off = **1 x right** & **2 x left** side, start the field on the **right-hand** side.

↓ 28	↑ 27	↓ 26	↑ 25	↓ 24	↑ 23	↓ 22	↑ 21	↓ 20	↑ 19	↓ 18	↑ 17	↓ 16	↑ 15
↓ 14	↑ 13	↓ 12	↑ 11	↓ 10	↑ 09	↓ 08	↑ 07	↓ 06	↑ 05	↓ 04	↑ 03	↓ 02	↑ 01

**Rhythm 50 Left:**

6 m seed drill/15 m equipment or 8 m seed drill/20 m equipment.

Shut off = **2 x right** & **2 x left** side, start the field on the **left-hand** side.

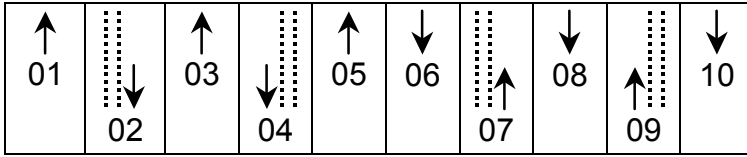

**Rhythm 51 Right:**

6 m seed drill/15 m equipment or 8 m seed drill/20 m equipment.

Shut off = **2 x right** & **2 x left** side, start the field on the **right-hand** side.

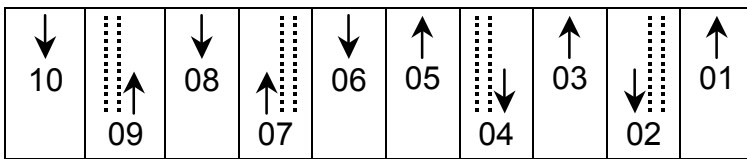

**Rhythm 52 Left:**

4 m seed drill/18 m equipment or 6 m seed drill/27 m equipment.

Shut off = **2 x right** & **2 x left** side, start the field on the **left-hand** side.

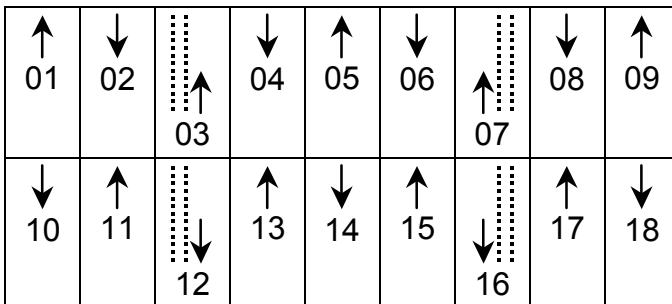

**Rhythm 53 Right:**

4 m seed drill/18 m equipment or 6 m seed drill/27 m equipment.

Shut off = **2 x right** & **2 x left** side, start the field on the **right-hand** side.

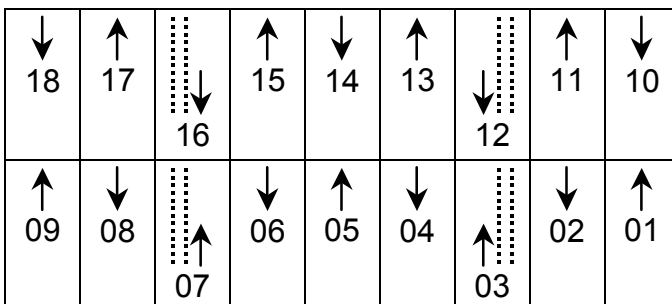

**Rhythm 54 Left:**

6 m seed drill/20 m equipment.

Shut off = **1 x right & 2 x left** side, start the field on the **left** side.

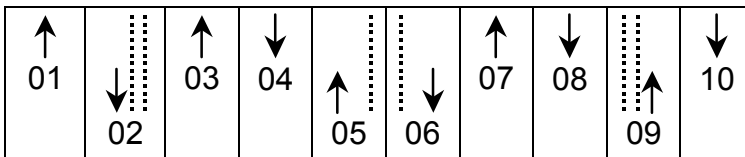

**Rhythm 55 Right:**

6 m seed drill/20 m equipment.

Shut off = **2 x right & 1 x left** side, start the field on the **right-hand** side.

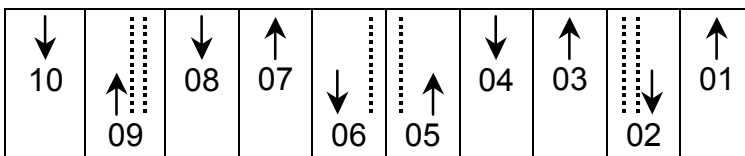

**Rhythm 56 Left:**

6 m seed drill/21 m equipment or 8 m seed drill/28 m equipment.

Shut off = **2 x right & 2 x left** side, start the field on the **left-hand** side.

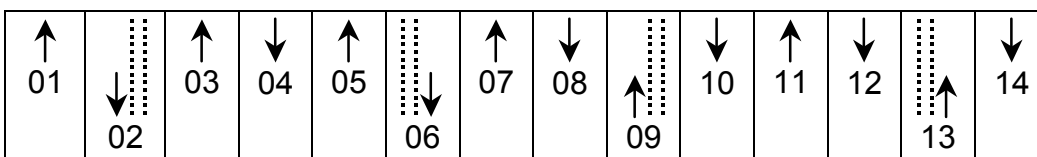

**Rhythm 57 Right:**

6 m seed drill/21 m equipment or 8 m seed drill/28 m equipment.

Shut off = **2 x right & 2 x left** side, start the field on the **right-hand** side.

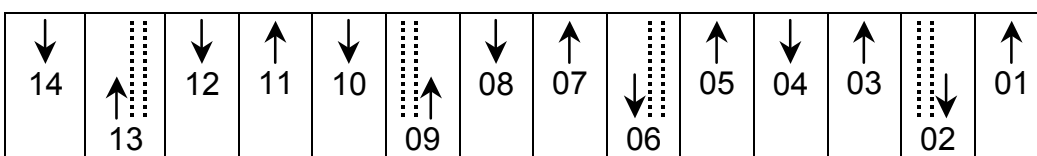

**Rhythm 60/62 Left:**

6 m seed drill/28 m equipment.

Shut off = **1 x right & 2 x left** side, start the field on the **left-hand** side.

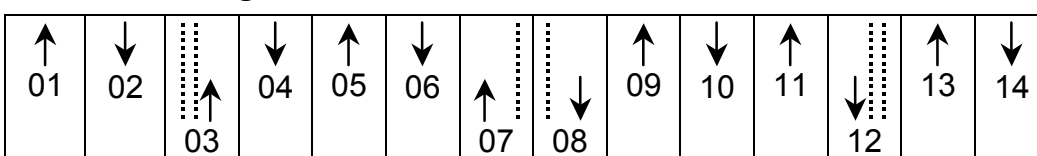

**Rhythm 61/63 Right:**

6 m seed drill/28 m equipment.

Shut off = **2 x right** & **1 x left** side, start the field on the **right-hand** side.

